



BSA

SPARES

1949-53

A MODELS

TWIN CYLINDER

500 c.c. and 650 c.c.

20-10374 C



**CLASSIC
BIKE SPARES**

1949 to 1953

MODELS

A7	500 c.c.	O.H.V.	(Rigid Frame)
A7	500 c.c.	„	(Spring Frame)
STAR TWIN	500 c.c.	„	(Spring Frame)
A10	650 c.c.	„	(Rigid Frame)
A10	650 c.c.	„	(Spring Frame)



**SUFFIX NUMBERS TO BE USED TO IDENTIFY VARYING FINISHES FOR
'A' GROUP MOTOR CYCLES**

/001	Cadmium
/003	Bright Chrome
/007	Black Enamel
/017	Chrome Plate, Black Lined Gold
/019	Chrome Plate, Matt Silver Lined Red
/021	Polished Aluminium
/024	Polychromatic Silver Beige
/026	Chrome Plate and Silver Beige Lined Red
/036	Maroon and Chrome Lined Gold
/037	Maroon only
/038	Metallic Green and Chrome Plate Lined Dark Green
/039	Metallic Green
/040	Dark Green
/041	Chrome Rim and Maroon Hub
/042	Chrome Rim and Dark Green Hub
/043	Chrome Rim and Beige Hub
/044	Chrome Rim and Black Hub

When ordering components with varying finishes, i.e., Petrol Tanks, Wheels, Rims, Brake Rods, Front Fork Oil Seal Holder — please state finish required by adding the appropriate suffix number to part number.

EXAMPLE. Petrol Tank

Metallic Green and Chrome Plate Lined Dark Green — 67 - 8104/038

SPARKING PLUGS

Champion Sparking Plugs Ltd., Feltham, Middlesex

ELECTRICAL EQUIPMENT

J. Lucas Ltd., Great King Street, Birmingham

SPEEDOMETERS

Smith's Motor Accessories, Cricklewood Works, London



SPARES AND REPAIRS

Please carry out the following in order to ensure prompt attention and correct execution of orders.

SPARES

1. Parts forwarded as patterns and all orders for spares should be addressed to B.S.A. Motor Cycles Ltd., Service Department, Birmingham 11.
2. When ordering parts the frame and engine numbers must be quoted. The former will be found stamped on the seat or the head tube lug and the latter on the nearside of the crankcase immediately below the cylinder base. It is essential that the component numbers of the parts required be clearly stated.
IMPORTANT.—In quoting engine and frame numbers the full numbers, including prefix letters, MUST BE GIVEN
3. To avoid delay orders for spare parts should be written on a separate order form or sheet of paper to correspondence on other matters.

REPAIRS

4. All motor cycles, engines, sidecars, or components for repair, must be consigned to B.S.A. Motor Cycles Ltd., "Repairs," Birmingham 11.
5. In cases where we are simply instructed to "overhaul," the machine or component will be entirely dismantled and all worn parts renewed, re-assembled and tested in a suitable manner.
6. When sending complete motor cycles to us such accessories as lamps, horns, speedometers, tools, etc., should be removed, as they are liable to be damaged or lost in transit, for which we cannot accept liability.
7. In the case of telephone enquiries relating to the repair of motor cycle or sidecar parts customers are requested to communicate with the Repairs Department. Telephone number : Birmingham Victoria 2234.
8. It frequently happens that parts are forwarded to us which do not bear the sender's name and address. Care in this respect will prevent delay and annoyance.
9. All goods must be consigned to us carriage paid.
10. B.S.A. Motor Cycles Limited reserve the right to charge for all goods supplied at prices ruling at time of delivery.
11. It must be understood that when no Ledger Account is open with the Company orders must be accompanied by a remittance. At the same time instructions should be given as to the method of despatch (either post, passenger or goods train), and such charges should be included in the remittance. All cheques and Postal Orders should be made payable to B.S.A. Motor Cycles Limited.
12. Complaints relative to defects in tyres, saddles, and electrical equipment should be sent direct to the manufacturer of such articles as these goods are only guaranteed in accordance with the respective makers' warranty.

B.S.A. Motor Cycles Ltd., reserve the right to alter the designs or any constructional details of their manufactures at any time without giving notice.

COPY OF B.S.A. MOTOR CYCLE SPARE PARTS GUARANTEE

We give the following guarantee with B.S.A. Motor Cycle Spare Parts, instead of the guarantee implied by statute or otherwise, as to the quality or fitness of such parts for the purpose for which they are intended, any such implied guarantee being in all cases excluded, nor can any claim for consequential damages be entertained.

WE GUARANTEE, subject to the conditions mentioned below, that all precautions which are usual and reasonable have been taken by us to secure excellence of materials and workmanship, but this guarantee is to extend and be in force for six months only from the date of purchase, and the damages for which we make ourselves responsible under this guarantee are limited to the replacement of any part which may have proved defective.

WE UNDERTAKE, subject to the conditions mentioned below, to make good at any time within six months any defects in these respects. As motor cycles are easily liable to derangement by neglect or misuse, this guarantee does not apply to defects caused by wear and tear, misuse, or neglect. The term "misuse" shall include among others the following acts : The attaching of a sidecar to the motor cycle in such a manner as to cause damage or calculated to render the latter unsafe when ridden ; the use of a motor cycle or a motor cycle and sidecar combined when carrying more persons or a greater weight than they were designed to bear.

REPAIRS AND RENOVATIONS GUARANTEE

Any B.S.A. motor cycle sent to us to be replated, re-enameled, or repaired will be treated upon the same conditions as if it were a new motor cycle, *i.e.*, we guarantee that all precautions which are usual and reasonable have been taken by us to secure excellence of material and workmanship, such guarantee to extend and be in force for six months only from the time such work shall have been executed, and this guarantee is in lieu and in exclusion of any Common Law or statute warranty, and the damages recoverable are limited to the cost of any further work which may be necessary to amend and make good the work found to be defective.

CONDITIONS OF GUARANTEE

If a defective part should be found in our motor cycles it must be sent to our Service Department, carriage paid, and be accompanied by an intimation from the sender that he desires it repaired free of charge under our guarantee, and he must also furnish us at the same time with the number of the machine and engine, which will be found stamped on the seat or head tube lug and crankcase respectively, the name of the Dealer from whom he purchased, and the date of the purchase.

Failing compliance with the above no notice will be taken of anything which may arrive but such articles will lie here at the risk of the sender, and this guarantee or any implied guarantee shall not be enforceable.

We do not guarantee the specialities of other firms, such as tyres, electrical equipment, saddles, etc., or of any component part supplied to the order of the purchaser differing from our standard specifications, whether supplied with our motor cycles or otherwise

THE TERM "AGENT"

We do not appoint agents for the sale of our Motor Cycles or other goods. We assign to Motor Cycle Dealers (styled "Regional Dealers"), who carry on business on their own account, areas in which they have the exclusive or other right to sell goods purchased from us. A Regional Dealer purchasing from us, or a Sub-Dealer purchasing from him, may, on our behalf (as our agent for the purpose only) give the guarantee printed above. Any such dealer is not authorised to advertise, incur any debts, or transact any business whatsoever on our account, nor is he authorised, so as to bind us to give any warranty or make any representation on our behalf or to sell subject to or with any conditions other than those contained in such guarantee.

CLASSIC
BIKE SPARES

LIST OF B.S.A. STOCKISTS

Save time and postage by contacting your nearest B.S.A. Stockist for B.S.A. Spare Parts, Spare Part Catalogues, Instruction Books, Transfers, etc. All B.S.A. Dealers carry stocks of B.S.A. Spare Parts but the following appointed Stockists maintain a comprehensive range.

Town.	Name of Stockist.	Address.	Telephone No.	Telegraphic Address.
Aberdeen	J. Dawson	24-26, Thistle Street	25556	
„	George Cheyne (Cycles) Ltd.	147, Holburn Street	26027	Motobike, Aberdeen.
Aberystwyth	Gwalia Motor Co.	North Parade	525	
Accrington	W. Snape	379, Blackburn Road	4724	
Aldershot	Phillips Bros. (Aldershot) Ltd.	Birchett Road	1111/2	Phillips Cycles, Aldershot.
Alloa	J. G. Robertson	55-57, High Street	193	
Andover	Corbett & Ellis (Andover) Ltd.	Weyhill Road	2991	
Aylesbury	Eborn's Garage	44, Walton Street, Aylesbury	150	Eborn's, Aylesbury.
Banbury	Trinder Bros.	2 and 3, Broad Street	2546	
Barnsley	T. Garner & Son	Sheffield Road	2866	
Bedford	The Imperial Cycle Co.	58, St. Loyes	2374	
Belfast	W. J. Chambers	106 and 108, Donegall Pass	27253/4	Fastmote, Belfast.
Biggleswade	Bryants	25, 27, 72 and 74, Shortmead Street	3108	
Birkenhead	Bob Simister Ltd.	540, New Chester Road, Rock Ferry	1452	
Birmingham	County Cycle & Motor Co. Ltd.	266, Broad Street	Midland 2671	
		104, Bath Row (Repairs)	Midland 2817	
		(Closed Saturday, 1 p.m.)		
„	C. E. Cope & Sons Ltd.	481-487, Hagley Road, Edgbaston 17		
		Bearwood 2246/7		
„	Shovelbottom's Ltd.	376, Ladypool Road, Sparkbrook 12		
		South 2212		
Blackburn	Shuttleworth & Geldart	15, Great Bolton Street	6678	
Blackpool	J. Hall & Son	102/6, Devonshire Road (Opposite		
		School) 22130		
Bolton	Charlie Robinson	119 and 121, Higher Bridge Street	3931	
Boscombe	Craze Bros.	473 and 475, Christchurch Road		
(Bournemouth)		Boscombe 34063		
Bradford	C. Sidney Ltd.	107, Manningham Lane	29889	
Braunton	C. M. Ray	The Square	344	
Bridgwater	Anderson & Wall	18, St. Mary Street	2416	Anderson & Wall, Bridgwater.
Brighton	Redhill Motors (Brighton) Ltd.	104, North Road	5281	
Bristol	S. J. Fair Motors Ltd.	201/3, Cheltenham Road	46238	
Bromsgrove	Harold Tozer (Bromsgrove) Ltd.	110, Birmingham Road	3228	
Brynmawr	Jayne's Motors	Cymbach Garage	271	
Bury	Arthur Coyle (Prop. W. Hudson)	30/32, Walmersley Road	714	Coyle Motors, Bury.
Bury-St.-Edmunds	Barclay Motors	Kings Road Corner	2345	
Cambridge	King & Harper Ltd.	Milton Road Corner	55201	Motors, Cambridge.
Canterbury	Marcel Hallet	St. Dunstan's Street	3046	
Cardiff	Car Distributors (Cardiff) Ltd.	134-140, City Road	30022	
„	Robert Bevan & Son	29/35, Castle Street	1808	
Carlisle	W. T. Tiffen & Son	Irishgate Brow	25024	Tiffen, Irishgate, Carlisle.
Carmarthen	W. Edwards & Sons (Carmarthen) Ltd.	Towy Garage	482/3	Edwards Garage, Carmarthen.
Castleford	Barrett's Motor Cycles	27-35, Aire Street	2983	

CLASSIC
BIKE SPARES

Town	Name of Stockist.	Address.	Telephone No.	Telegraphic Address.
Chapel-en-le-Frith	E. W. Bowers	129, Town End	144	
Cbatham	Grays	14-16, High Street	4005	
Chelmsford	Hadlers Garage Ltd.	New Street	4844/5	Hadler, Chelmsford.
Cheltenham	Leslie Paynter	Bath Street	2887	Paynter's Garage, Bath Street, Cheltenham.
Chester	Davies Bros.	34, Bridge Street	510	
Chichester	W. Goodridge & Co. Ltd.	East Street	2033	
Colchester	G.B.R. Motors Ltd.	63a, High Street	2632	
Colwyn Bay	Gilbert Emery	70/72, Abergele Road	2151	
Coventry	Coventry Motor Mart Ltd.	London Road	2146/7	Coventry Motor Mart.
Croydon	Godfreys Ltd.	228/234, London Road	Croydon 3641/2	Gofrabike, Croydon.
Dagenham (Essex)	Smith & Double	New Road	Rainham 3284/2786	
Dalton-in-Furness	H. Holme	Ulverston Road	25	
Darlington	The Duplex Motor & Cycle Co. Ltd.	10-16, Grange Road	Darlington 2071	Duplex, Darlington.
"	White Bros.	205/9, Northgate	2379	
Dartford	Schweizo Bros.	177, Lowfield Street	4279	
Derby	Ingle's Provincial Garages Ltd.	Walbrook Road	45289	
Doncaster	W. Cusworth (Doncaster) Ltd.	7, Hail Gate	4594	
Dorchester	Tilleys	31, South Street	367	Motors, Dorchester.
Douglas (I.O.M.)	Gilbert Harding	18, Duke Street	Douglas 170	
Dudley	Chas. E. Cope & Sons Ltd.	193, High Street	Dudley 3464/5/6	
"	James Parkes & Sons	7, King Street	Dudley 2889	
Dundee	George McLean Ltd.	Riverside Drive	5087	Vehicles, Dundee.
Dunstable	B. G. England (Dunstable) Ltd.	Halfmoon Hill, London Road	843/4	
Eastbourne	Hurrey Woodham	118, Seaside	756	Jempsons, Eastbourne
Edinburgh	J. R. Alexander & Co. Ltd.	10/14, Lothian Road	21176	Motor Cycles, Edinburgh.
Elgin	Farquharsons	55/57, High Street	7188	Elgin 7188
Enfield	D. J. Shepherd & Co. (Enfield) Ltd.	434/6, Hertford Road, Enfield Highway Howard 1631		
Exeter	P. Pike & Co. Ltd.	Alphington Street	3061	Piko, Exeter.
Frome	Difazio & Bishop	25, Catherine Street	2913	
Gateshead, 8	O. Carmichael & Son	75, 83 and 87, High Street West	71815	
Glasgow	Bell Bros. (H.P.) Ltd.	215/223, St. Georges Road	Douglas 6414	Douglas 6414 Glasgow.
"	J. R. Alexander & Co. Ltd.	264-280, Great Western Road Douglas 3802/3/4		Alex Moto, Glasgow.
Gloucester	Harpers Garage	23a, Worcester Street	23187	Gloucester 23187
Grimsby	H. J. Cresswell & Sons Ltd.	13/15, Osborne Street	2220	
Guernsey	Millard & Co. Ltd.	Victoria Road	777	Millard Motors, Guernsey
Guildford	E. Pascall (Guildford) Ltd.	11/12, Woodridbge Road Guildford 2274/5/6		
Harrogate	H. Aclam (Prop. H. Baynes)	11, Bower Road	5125	
Harrow	E. T. Pink (Harrow) Ltd.	Station Road	0044/5	Pink, Harrow.
Haywards Heath	Dinnages Garages Ltd.	Wivelsfield Road	1146	
Hereford	A. Kear & Co.	52b, Commercial Street	2239	Kear, Hereford.
Holbeach, Lincs.	G. Woodman	34, Fleet Street	3221	
Hove	Bradshaws	5/6, Western Road	Hove 35252/3	



6
**CLASSIC
BIKE SPARES**

<i>Town</i>	<i>Name of Stockist.</i>	<i>Address</i>	<i>Telephone No.</i>	<i>Telegraphic Address</i>
Huddersfield	Earnshaw	Manchester Road	1232	
Hull	Browns (Witham) Ltd.	47/49, Witham	33990/9	
"	Jordan & Co. (Hull) Ltd.	Story Street	36809	Gumpton, Hull.
Ilford	Smith & Double	Cranbrook Road	Valentine 3109	
Ipswich	Revetts Ltd.	Clarkson Street	2822	
Jersey	Colebrooks (Peter Perrio)	1 and 11, New Street	Central 642	Colebrooks, Jersey.
Keighley	Dick Ratcliffe	Coldshaw Garage, Haworth	Haworth 3133	
Kendal	Tom O'Loughlin	66, Stricklandgate	315	
Kirkcaldy	County Motors (Kirkcaldy) Ltd.	Junction Road	Dysart 5631	
Lancaster	Pye Motors Ltd.	Parliament Street	828	
Launceston	J. Wooldridge & Son	Western Road	21	Wooldridge, Launceston.
Leeds, 1	Watson-Cairns & Co. Ltd.	Lower Briggate	23379	Watson-Cairns, Briggate, Leeds.
Leicester	E. W. Campion & Son Ltd.	Welford Place	58054	
Lincoln	West's (Lincoln) Ltd.	116, High Street	10762-3-4	
Liverpool	Bee Cycle & Motor Co. Ltd.	17-19, Renshaw Street	Royal 6375/6	Bee Cycles, Liverpool.
"	Cundles	41 and 61, Byrom Street	Central 4148	Cundles, Central 4148.
Llawhaden	James Bowen & Sons	Llawhaden, near Narberth, Pem. Llawhaden 6		
London, W.1	Godfreys Ltd.	208, Great Portland Street	Euston 4632/4	Gofrabike, Fergate, London.
" N.W.1	J. Grose Ltd.	379-381, Euston Road	Euston 5231	
" W.5	Kays of Ealing Ltd.	8-10, Bond Street	Ealing 2813	Sparesokay, Ealux, London.
" S.E.13	F. Parks & Son Ltd.	404, High Street, Lewisham	Lee Green 0535	
" E.8	Eleanor Motors	265/7/9, Mare Street	Amherst 5134	
" E.7	Godfreys (Proprietors of Lovetts)	418, Romford Road, Forest Gate Grangewood 1234		
" E.6	Godfreys (Proprietors of Lovetts)	220 Barking Road, East Ham Grangewood 0933		
" N.12	George Grose Ltd.	834, High Road, Finchley	Hillside 2149	
" N.12	Glanfield Lawrence Ltd.	Junction Great North Road and North Circular Road Finchley 0091		Glanfin, Norphone, London.
" S.E.11	Writers Ltd.	161/5, Kennington Lane	Reliance 1362	
" S.W.11	Owen Bros.	19, Battersea Rise, Clapham Junction Battersea 7816/7		
" S.W.6	Claude Rye Ltd.	897/921, Fulham Road, Fulham Renown 4246/7/8		Ryebikes, Walgreen, London.
" W.12	Turners Stores	81-83, Goldhawk Road, Shepherd's Bush Shepherds Bush 2436		
" W.3	Whitby's of Acton Ltd.	273, The Vale, Acton Shepherds Bush 5355/6		
" S.E.18	Cleares	1 & 125, High Street, Woolwich Woolwich 0174		
" S.E.15	West End Motors Ltd.	171, High Street, Peckham	Newcross 2589	
" N.W.10	Stocombes Ltd.	269, Neasden Lane, Neasden		Gladstone 2088-0508
" N.15	Godfreys	94 & 96, High Road, South Tottenham S.T.A. 9960		
Lowestoft	R. Wright	67-69, London Road South	645	



<i>Town.</i>	<i>Name of Stockist.</i>	<i>Address.</i>	<i>Telephone No.</i>	<i>Telegraphic Address.</i>
Maidstone	Redhill Motors (Maidstone) Ltd.	The Broadway	3096	
Manchester	Colmore Depot Ltd.	17-18, Watson Street	Blackfriars 3322	
"	Tom Davies (Motors) Ltd.	233, Deansgate	Blackfriars 0681	
"	Fred Fearnley Ltd.	692-4, Ashton Old Road	East 1445/6	Fernbike, Manchester.
"	Webb & Waite Ltd., Stretford Garage	Chester Road, Stretford	Longford 2223	Courteous, Stretford.
Mansfield	Henstocks..	128, Chesterfield Road North	329	Henstock 329 Mansfield.
Middlesbrough	J. T. Dickinson (Middlesbrough) Ltd.	160-162, Lindthorpe Road	3861	
Neath	Fred Rist ..	16, Windsor Road	Neath 780	
Newcastle-on-Tyne	Dene (Newcastle) Motor Co. Ltd.	Haymarket	21837	Ened, Newcastle-on-Tyne.
Newton Abbott	J. E. Green & Co.	87, Queen Street	653	
Newport (Mon.)	R. J. Ware & Sons	69, Commercial Street	66206	
Newton Stewart	Associated Car Sales Co. Ltd.	Albert Street, Newton Stewart		
Northampton	P. C. Spokes & Son Ltd.	1, Henry Street	1160	
Norwich	Chapmans (Norwich) Ltd.	38-42, Duke Street	24727	
Nottingham	E. W. Campion & Son Ltd.	Station Street	52961	
Oswestry	Roy Evans	Willow Street	201	
Oxford	H. F. Temple	69, High Street, St. Thomas	2485	
Parkstone ..	Bob Foster	472/4, Ashley Road	68	
Perth	M. Shaw & Sons	143, High Street	483	
Peterborough	Burrows Bros.	55-57, Westgate	2154	
Plymouth ..	P. Pike & Co. Ltd.	46, Union Street	Plymouth 3108	Piko, Plymouth
Pontardulais	T. Griffiths	Forest Garage	Pontardulais 323	
Portsmouth	Jenkins & Purser Ltd.	277-281, Copnor Road	5722	
"	Percy Kiln Ltd.	65/67, Elm Grove, Southsea	Portsmouth 4793	
"	Glanfield Lawrence	147/157, Fratton Road	74331	
Preston	Loxham's Garages Ltd.	Central Garage, Charnley Street, Fishergate	Sales Dept. 4242 Service Dept. 4243	Loxhams, Preston.
Pulborough	Gray & Rowsell	Bury Gate	Bury 4	
Radcliffe	Will Lord	115, Blackburn Street	2002	
Reading	Fortescue Bros. Ltd.	1-2, West Street	4143	4143 Reading.
"	Phillips & Bloomfield Motors Ltd.	10/24, South Street	2635	
Redhill	The Redhill Motor & Cycle Works Ltd.	50, Brighton Road	327	
Romford	G. H. Wilson	George Street	2660	
Rotherham	Ernest Cross	55, Drummond Street	Rotherham 3987	
Salisbury ..	Pankhurst (Weymouth) Ltd.	78 Exeter Street	5222/3	
Scarborough	E. Andrew	Roscoe Street	Scarborough 1857	
Sevenoaks	Angus Motor Cycles	Station Parade	3338	
Sheffield	Walter Wragg Ltd.	Stanley Works, Wellington Street	26098	26098 Sheffield.
Shotland	Thomson's Garage	Esplanade, Lerwick	85	Thomson's Garage, Lerwick.
Shrewsbury	J. R. Meredith	Coleham Head	4533	
Sittingbourne	Scoones' Garage	9, West Street	66	Scoones, Sittingbourne.
Slough	Sid Moram	Wexham Corner, High Street	23767	



<i>Town.</i>	<i>Name of Stockist.</i>	<i>Address.</i>	<i>Telephone No.</i>	<i>Telegraphic Address.</i>
Skipton	Craven Motor Co.	Caroline Square	221	Skipton 221
Southampton ..	Alec Bennett Ltd.	152, Portswood Road ..	54081-2-3	
Southport	H. F. Brockbank	62, King Street	5054	
St. Austell	Kellaway (Cycles & Motors) Ltd. ..	34, South Street	102	
St. Helens	Geoff. Duke Ltd.	Greenfield Road Garage ..	3918	
Stockport	Theobald & Coppack	6, Chestergate	2843	Theobald Coppack, Stockport.
Stoke-on-Trent ..	J. & N. Bassett	Howards Place, Shelton ..	2890	
Sunderland	Dunns Garage (Sunderland) Ltd. ..	Wheatsheaf Corner	4994	
Sutton-in-Ashfield	W. Henstock	Forest Street Garage	90	Henstock, 90, Sutton-in-Ashfield.
Swansea	Handel Davies Ltd.	213, Oxford Street	2956	
Swindon	Easters Garage	5/8, Manchester Road ..	2788	
Taunton	W. P. Edwards (Motors) Ltd. ..	58, East Street	2943	Edwards, Motor Cycles, Taunton.
Thames Ditton ..	Comerfords Ltd.	Portsmouth Road	Emberbrook 2323/4	
Thetford	W. & G. Lambert Ltd.	Castle Street	2217	
Torquay	P. H. Sharam Ltd.	244/6, Union Street	4184 and 7255	
Tunbridge Wells ..	G. E. Tunbridge	21, London Road	416	Motors, Tunbridge Wells.
Twickenham	C. A. Blay	192, Heath Road	Popesgrove 2103 and 1435	
Uxbridge	Miles Motors Ltd.	60, High Street	Uxbridge 125	
Wakefield	Parkinson (Wakefield) Ltd. ..	Ings Road	2087	
Walsall	The Motor Cycle Mart	12, Ablewell Street	3363	
Warrington	Jack Frodsham Ltd.	37a, Winnick Street	471	
Watford	Lloyd Cooper & Co.	61, Queen's Road	2125	
Westcliff-on-Sea ..	J. Costin & Sons	233-5-7, London Road ..	Southend 2215	
Weston-super-Mare	Wyvern's of Weston Ltd.	47, Drove Road	3409	Wyvern's, Weston-super-Mare.
Weybridge	W. L. Lewis & Sons	51, Church Street	210	
Weymouth	Tilleys	9, Frederick Place	72	
Winchester	Winchester Cycle & Motor Co. ..	Jewry Street	2728	
Wolverhampton ..	C. E. Cope & Sons Ltd.	163-9, Stafford Street ..	24605/6	
Worcester	W. J. Bladder & Son	52, Sidbury	2438	Bladder, Sidbury, Worcester.
Worthing	Wheatlands	56, Broadwater Street West ..	1224	
Yeovil	The Yeovil Motor Mart	Handford	267	Motor Mart, Yeovil.
York	C. S. Russell (York) Ltd.	Lawrence Street	3793	Russell, Lawrence Street, York.



Plate 1

ENGINE—"A" GROUP

Plate Ref. Number.	Model.	Part No.	Description.	Number per set.
1	A7, A10 and Star Twin	29-410	Valve spring cotter	4
2	A7, A10 and Star Twin	67-34	Valve spring collar	4
3	A7, A10 and Star Twin	67-440	Valve spring (inner)	4
4	A7, A10 and Star Twin	67-439	Valve spring (outer)	4
5	A7, A10 and Star Twin	67-31	Valve guide (exhaust)	2
6	A7, A10 and Star Twin	67-33	Valve spring cup (bottom)	4
7	A7	67-394	Valve (inlet)	2
	A10	67-323	Valve (inlet)	2
	A7, Star Twin	67-531	Valve (inlet)	2
	A7	67-29	Valve (inlet) (up to 1951)	2
	Star Twin	67-189	Valve (inlet) (up to 1951)	2
8	A7, A10 and Star Twin	65-2153	Rocker box inspection cover stud nut	8
9	A7, A10 and Star Twin	24-978	Rocker box inspection cover nut washer	8
10	A7, A10 and Star Twin	67-263	Rocker box inspection cover	2
11	A7, A10 and Star Twin	67-279	Rocker box inspection cover joint washer	2
12	A7, A10 and Star Twin	67-280	Rocker box inspection cover stud	7
13	A7, A10 and Star Twin	67-343	Rocker box cover stud	1
14	A7, A10 and Star Twin	67-259	Rocker box	1
15	A7, A10 and Star Twin	67-261	Rocker box bolt (long)	4
16	A7, A10 and Star Twin	24-8784	Rocker box bolt washer	4
17	A7, A10 and Star Twin	24-6040	Rocker box steady stay stud nut	4
18	A7, A10 and Star Twin	67-1245	Rocker box stud	4
19	A7, A10 and Star Twin	36-382	Rocker box stud nut washer	2
20	A7, A10 and Star Twin	67-346	Engine steady stay	2
21	A7	67-395	Valve (exhaust)	2
	A10	67-324	Valve (exhaust)	2
	A7, Star Twin	67-532	Valve (exhaust)	2
	A7	67-30	Valve (exhaust) (up to 1951)	2
	Star Twin	67-190	Valve (exhaust) (up to 1951)	2
22	A7, A10 and Star Twin	65-306	Rocker oil feed pipe banjo screw	2
23	A7, A10 and Star Twin	67-450	Rocker oil feed pipe complete	1
24	A7, A10 and Star Twin	67-64	Valve Rocker spindle	2
25	A7, A10 and Star Twin	67-61	Valve rocker thrust washer	2
26	A7, A10 and Star Twin	67-62	Valve rocker spindle washer (spring)	4
27	A7, A10 and Star Twin	67-266	Exhaust valve rocker (N/S)	1
28	A7, A10 and Star Twin	67-56	Rocker adjusting screw	4
29	A7, A10 and Star Twin	24-563	Rocker adjusting nut	4
30	A7, A10 and Star Twin	67-60	Valve rocker thrust washer	6
30A	A7, A10 and Star Twin	67-267	Exhaust valve rocker (O/S)	1
31	A7, A10 and Star Twin	65-311	Valve rocker spindle nut	2
32	A7, A10 and Star Twin	36-481	Valve rocker spindle washer	2
33	A7, A10 and Star Twin	67-265	Valve rocker (inlet) (O/S)	1
34	A7, A10 and Star Twin	67-264	Valve rocker (inlet) (N/S)	1
35	A7 and Star Twin	67-2675	Exhaust pipe (O/S)	1
	A10	67-2720	Exhaust pipe (O/S)	1
36	A7 and Star Twin	67-2679	Exhaust pipe (N/S)	1
	A10	67-2722	Exhaust pipe (N/S)	1
37	A7, A10 and Star Twin	15-203	Rocker oil feed pipe union washer	2
38	A7, A10 and Star Twin	2-2138	Cylinder and head bolt washer	9
39	A7, A10 and Star Twin	67-258	Cylinder head bolt (medium)	2
40	A7, A10 and Star Twin	67-277	Rocker box joint washer (small)	2
41	A7, A10 and Star Twin	67-278	Rocker box joint washer	1
42	A7, A10 and Star Twin	67-254	Cylinder and head bolt	4
43	A7	67-380	Cylinder head with fixed fittings	1
	A7 and Star Twin	67-524	Cylinder head with fixed fittings	1
	A10	67-250	Cylinder head with fixed fittings	1
	A7	67-24	Cylinder head with fixed fittings (up to 1951)	1
	Star Twin	67-182	Cylinder head with fixed fittings (up to 1951)	1
44	A7, A10 and Star Twin	36-382	Rocker box stud nut washer	2
45	A7, A10 and Star Twin	2-49	Rocker box stud nut	2
46	A7	65-1162	Carburettor joint washer	3
	A10 and Star Twin	65-1232	Carburettor joint washer	3
47	A7 and A10	67-120	Carburettor drip shield	1
	Star Twin	67-527	Carburettor drip shield	1
48	A7, A10 and Star Twin	36-382	Carburettor fixing bolt washer	2
49	A7, A10 and Star Twin	2-120	Carburettor fixing bolt	2
50	A7 and Star Twin	67-191	Gudgeon pin circlip	4
	A10	66-954	Gudgeon pin circlip	4
51	A7 and Star Twin	67-392	Gudgeon pin	2
	A10	65-440	Gudgeon pin	2
52	A7 and Star Twin	67-393	Gudgeon pin bush	2
	A10	67-298	Gudgeon pin bush	2



10
CLASSIC
BIKE SPARES

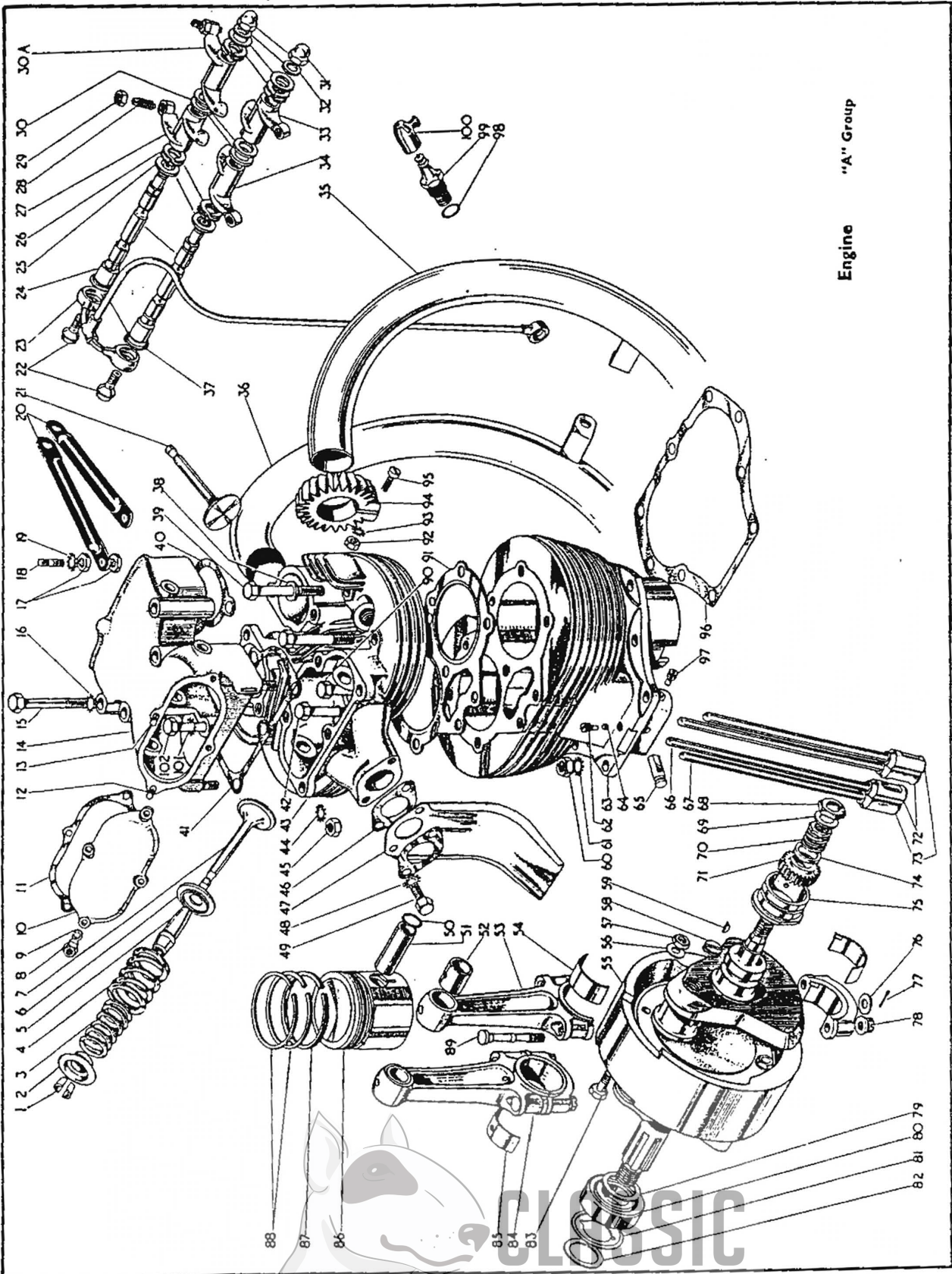

Plate Ref. Number	Model.	Part No.	Description.	Number per set.
53	A7 and Star Twin	67-389	Connecting rod with bushes, bolts and nuts (Gearside)	1
	A10	67-268	Connecting rod with bushes, bolts and nuts (Gearside)	1
	A7 and Star Twin	67-228	Connecting rod with bushes, bolts and nuts (Gearside) (up to 1951)	1
	A10	67-268	Connecting rod with bushes, bolts and nuts (Gearside) (up to 1951)	1
54	A7, A10 and Star Twin	67-226	Connecting rod big end bush (halves)	3
55	A7 and Star Twin	67-384	Crankshaft and flywheel assembled	1
	A10	67-664	Crankshaft and flywheel assembled	1
	A7 and Star Twin	67-615	Crankshaft and flywheel assembled (up to 1951)	1
56	A7, A10 and Star Twin	15-5155	Flywheel bolt washer	6
57	A7, A10 and Star Twin	67-302	Flywheel bolt nut	6
58	A7, A10 and Star Twin	65-615	Crankshaft oil hole grub screw	2
59	A7, A10 and Star Twin	15-40	Crankshaft pinion gear key	1
60	A7, A10 and Star Twin	24-5160	Crankcase and cylinder barrel stud nut	9
61	A7, A10 and Star Twin	36-382	Crankcase and cylinder barrel stud washer	9
62	A7, A10 and Star Twin	67-276	Tappet securing screw	1
63	A7 and Star Twin	67-378	Cylinder barrel	1
	A7 and Star Twin	67-50	Cylinder barrel (up to 1951)	1
	A10	67-253	Cylinder barrel	1
64	A7, A10 and Star Twin	7/8 in.	Tappet locating pin ball	1
65	A7, A10 and Star Twin	67-331	Tappet locating pin	1
66	A7 and Star Twin	67-398	Valve push rod (exhaust)	2
	A10	67-362	Valve push rod (exhaust)	2
67	A7 and Star Twin	67-396	Valve push rod (inlet)	2
	A10	67-360	Valve push rod (inlet)	2
68	A7, A10 and Star Twin	67-643	Crankshaft nut	1
69	A7, A10 and Star Twin	67-644	Crankshaft nut locking washer	1
70	A7, A10 and Star Twin	67-642	Crankshaft pump gear	1
71	A7, A10 and Star Twin	67-339	Crankshaft pinion	1
72	A7, A10 and Star Twin	67-333	Exhaust tappet	2
73	A7, A10 and Star Twin	67-332	Inlet tappet	2
74	A7, A10 and Star Twin	67-645	Crankshaft pump gear washer	1
75	A7, A10 and Star Twin	67-648	Crankshaft bush (Gearside)	1
76	A7, A10 and Star Twin	67-297	Connecting rod big end bolt washer	4
77	A7, A10 and Star Twin	35-702	Connecting rod bolt split pin	4
78	A7, A10 and Star Twin	67-1034	Connecting rod bolt nut	4
79	A7, A10 and Star Twin	67-671	Crankshaft shim (.005in.)	—
		67-672	Crankshaft shim (.010in.)	—
80	A7, A10 and Star Twin	67-670	Crankcase roller bearing	1
81	A7, A10 and Star Twin	67-349	Bearing shim (Drive side)	1
82	A7, A10 and Star Twin	67-2056	Engine sprocket distance piece (.005in.)	—
		67-2057	Engine sprocket distance piece (.010in.)	—
		67-2058	Engine sprocket distance piece (.030in.)	—
83	A7, A10 and Star Twin	67-301	Flywheel bolt	6
84	A7 and Star Twin	67-386	Connecting rod complete with bushes, bolts and nuts (Drive side)	1
	A10	67-317	Connecting rod complete with bushes, bolts and nuts (Drive side)	1
	A7 and Star Twin	67-228	Connecting rod complete with bushes, bolts and nuts (Drive side) (up to 1951)	1
	A10	67-268	Connecting rod complete with bushes, bolts and nuts (Drive side) (up to 1951)	1
85	A7, A10 and Star Twin	67-320	Connecting rod big end bush (drilled)	1
86	A7	67-460	Piston complete	2
	A7, Star Twin	67-533	Piston complete	2
	A10	67-423	Piston complete	2
	A7	67-81	Piston complete (up to 1951)	2
	Star Twin	67-103	Piston complete (up to 1951)	2
	A10	67-304	Piston complete (up to 1951)	2
87	A7 and Star Twin	67-410	Piston scraper ring	2
	A10	67-314	Piston scraper ring	2
88	A7 and Star Twin	67-407	Compression ring	4
	A10	67-311	Compression ring	4
89	A7, A10 and Star Twin	67-1033	Connecting rod bolt	4
90	A7, A10 and Star Twin	67-283	Cylinder and head bolt (short)	3
91	A7 and Star Twin	67-382	Cylinder head joint washer	1
	A10	67-255	Cylinder head joint washer	1
92	A7, A10 and Star Twin	21-5102	Exhaust pipe finned collar nut	2
93	A7, A10 and Star Twin	29-541	Exhaust pipe finned collar nut washer	2
94	A7, A10 and Star Twin	67-2694	Exhaust pipe finned collar	2
95	A7, A10 and Star Twin	21-6187	Exhaust pipe finned collar screw	2



Plate 1—continued

ENGINE—"A" GROUP

Plate Ref. Number.	Model.	Part No.	Description.	Number per set.
96	A7, A10 and Star Twin	67-256	Cylinder barrel base washer	1
97	A7, A10 and Star Twin	67-299	Tappet retaining screw	2
98	A7, A10 and Star Twin	66-102	Sparking plug washer	2
99	A7 and A10	65-114	Sparking plug	2
	A7 and Star Twin	67-529	Sparking plug	2
100	A7, A10 and Star Twin	65-213	Sparking plug cover	2
101	A7, A10 and Star Twin	24-8784	Rocker box bolt washer	1
102	A7, A10 and Star Twin	15-1355	Rocker box bolt	1

Plate 2

ENGINE—"A" GROUP

Plate Ref. Number	Model.	Part No.	Description.	Number per set.
1	A7, A10 and Star Twin	67-1704	Primary chain cover screw (long)	1
2	A7, A10 and Star Twin	67-1706	Primary chain cover screw (medium)	7
3	A7, A10 and Star Twin	67-1701	Primary chain cover	1
4	A7, A10 and Star Twin	67-1703	Primary chain	1
5	A7 and Star Twin	67-42	Primary chain cover oil filler plug washer	1
	A10	65-3365	Primary chain cover oil filler plug washer	1
6	A7, A10 and Star Twin	65-3364	Primary chain oil filler plug	1
7	A7, A10 and Star Twin	67-1705	Primary chain cover screw (short)	3
8	A7, A10 and Star Twin	67-1711	Primary chain cover oil level screw	1
9	A7, A10 and Star Twin	67-1709	Primary chain oil level screw washer	1
10	A7, A10 and Star Twin	67-453	Crankcase with fixed fittings (D/S)	1
	A7 and Star Twin	67-1227	Crankcase with fixed fittings (D/S) (up to 1951)	1
	A10	67-291	Crankcase with fixed fittings (D/S) (up to 1951)	1
11	A7, A10 and Star Twin	67-1292	Crankcase connecting bolt nut (top)	1
12	A7, A10 and Star Twin	36-382	Crankcase connecting bolt washer (top)	1
13	A7, A10 and Star Twin	67-1259	Magneto fixing nut (long)	1
14	A7, A10 and Star Twin	67-1258	Magneto joint washer	1
15	A7, A10 and Star Twin	24-5160	Magneto fixing nut	2
16	A7, A10 and Star Twin	36-382	Magneto fixing stud washer	3
17	A7, A10 and Star Twin	67-1245	Magneto fixing stud	3
18	A7, A10 and Star Twin	67-350	Crankcase engine plate connecting stud	3
19	A7, A10 and Star Twin	67-352	Crankcase connecting stud (front)	2
20	A7, A10 and Star Twin	67-74	Crankcase connecting stud	1
21	A7, A10 and Star Twin	67-1401	Oil retaining ball grub screw	1
22	A7, A10 and Star Twin	67-1400	Oil retaining ball spring	1
23	A7, A10 and Star Twin	1/16 in.	Oil retaining ball	1
24	A7, A10 and Star Twin	67-74	Cylinder barrel fixing stud	9
25	A7, A10 and Star Twin	67-686	Camshaft bush (D/S)	1
26	A7 and A10	67-334	Camshaft	1
	A7 and Star Twin	67-356	Camshaft	1
	A7 and Star Twin	67-695	Camshaft (up to 1951)	1
27	A7, A10 and Star Twin	67-686	Camshaft bush (G/S)	2
28	A7, A10 and Star Twin	67-337	Camshaft driving pinion	1
29	A7, A10 and Star Twin	67-686	Idler pinion bush	1
30	A7, A10 and Star Twin	67-707	Idler pinion spindle	1
31	A7, A10 and Star Twin	27-1386	Idler pinion key	1
32	A7, A10 and Star Twin	67-335	Idler pinion complete	1
33	A7, A10 and Star Twin	67-286	Idler pinion spindle bush	1
34	A7, A10 and Star Twin	67-708	Idler pinion spindle oil seal	1
35	A7, A10 and Star Twin	35-1896	Camshaft pinion key	1
36	A7, A10 and Star Twin	67-685	Camshaft pinion lockwasher	1
37	A7, A10 and Star Twin	24-7000	Camshaft pinion nut	1
38	A7, A10 and Star Twin	67-134	Crankcase breather washer (cork) (1/16 in.)	-
		67-135	Crankcase breather washer (cork) (3/32 in.)	-
		67-136	Crankcase breather washer (cork) (1/8 in.)	-
		67-137	Crankcase breather washer (cork) (3/16 in.)	-
		67-158	Crankcase breather washer (cork) (1/2 in.)	-
		67-159	Crankcase breather washer (cork) (13/16 in.)	-
		67-160	Crankcase breather washer (cork) (145 in.)	-
39	A7, A10 and Star Twin	67-130	Crankcase breather	1
40	A7 and A10	67-1882	Auto advance unit	1

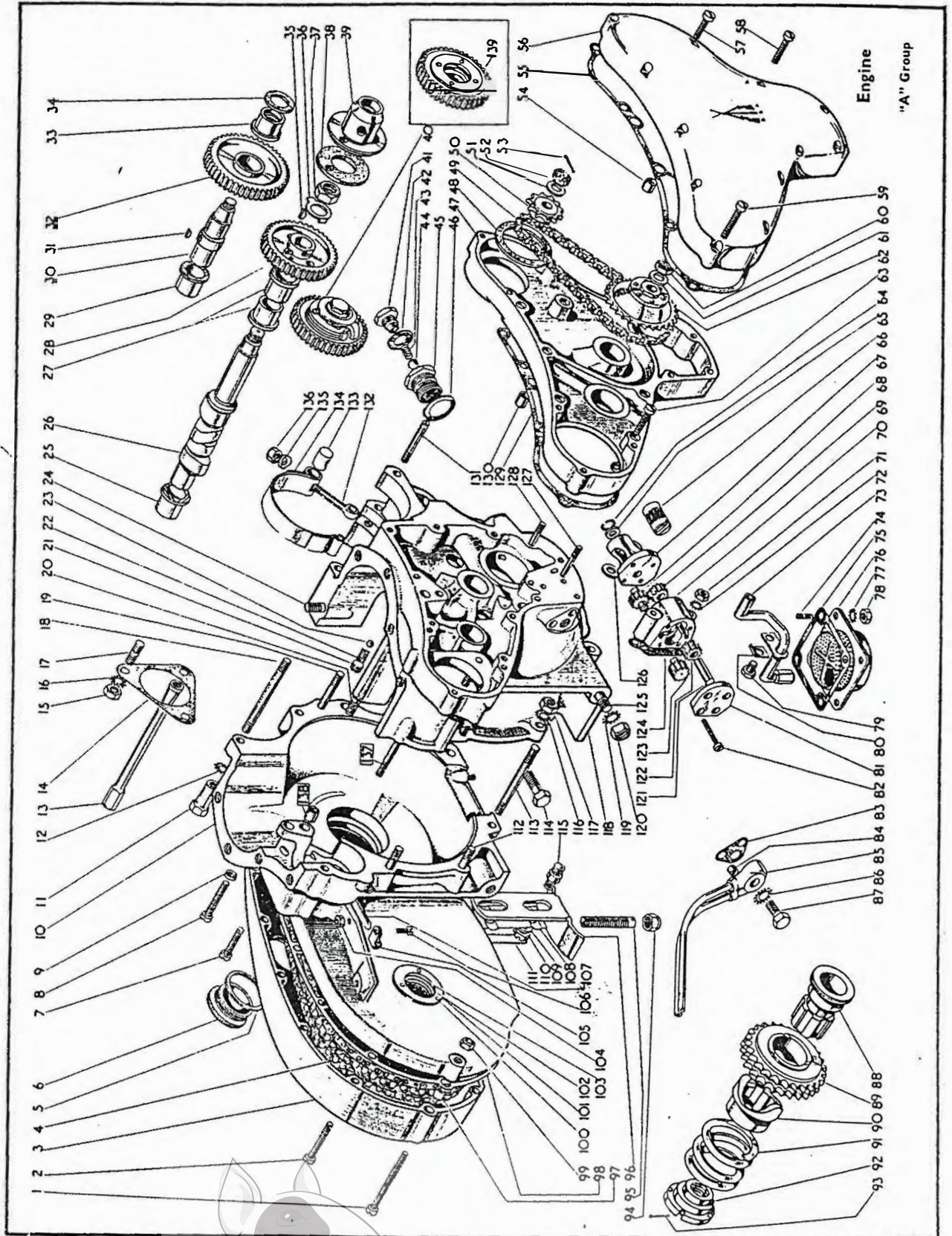

Engine
"A" Group

Plate 2—continued

ENGINE—"A" GROUP

Plate Ref. Number	Model.	Part No.	Description.	Number per set.
41	A7, A10 and Star Twin	67-1505	Oil release valve body plug	1
42	A7, A10 and Star Twin	67-1498	Oil release valve body plug washer	1
43	A7, A10 and Star Twin	67-1496	Oil release valve spring	1
44	A7, A10 and Star Twin	$\frac{1}{4}$ in.	Oil release valve ball	1
45	A7, A10 and Star Twin	67-1503	Oil release valve body	1
46	A7, A10 and Star Twin	67-1499	Oil release valve washer (fibre)	1
	A7, A10 and Star Twin	67-1502	Oil release valve complete assembled	1
47	A7, A10 and Star Twin	67-284	Timing cover (inner)	1
	A7 and Star Twin	67-142	Timing cover (inner) (up to 1951)	1
48	A7, A10 and Star Twin	19-1429	Dynamo packing washer (supplied by Lucas)	1
49	A7, A10 and Star Twin	67-296	Dynamo driving chain	1
50	A7, A10 and Star Twin	67-727	Dynamo driven sprocket	1
51	A7, A10 and Star Twin	19-1577	Dynamo sprocket washer (supplied by Lucas)	1
52	A7, A10 and Star Twin	19-1473	Dynamo sprocket nut (supplied by Lucas)	1
53	A7, A10 and Star Twin	35-698	Dynamo sprocket nut split pin	1
54	A7, A10 and Star Twin	66-3074	Outer cover dowel	2
55	A7, A10 and Star Twin	67-282	Outer timing cover joint washer	1
56	A7, A10 and Star Twin	67-287	Timing cover (outer)	1
	A7	67-146	Timing cover (outer) (up to 1951)	1
	Star Twin	67-157	Timing cover (outer) (up to 1951)	1
57	A7, A10 and Star Twin	67-133	Outer timing cover screw	3
58	A7, A10 and Star Twin	67-132	Outer timing cover screw (long)	4
59	A7, A10 and Star Twin	65-3063	Outer timing cover screw	5
60	A7, A10 and Star Twin	2-449	Dynamo driving sprocket nut	1
61	A7, A10 and Star Twin	35-4224	Dynamo driving sprocket lockwasher	1
62	A7, A10 and Star Twin	67-721	Dynamo driving sprocket	1
63	A7, A10 and Star Twin	67-133	Inner timing cover screw	4
	A7, A10 and Star Twin	67-1381	Oil pump complete	1
64	A7, A10 and Star Twin	67-1390	Oil pump driving spindle spring ring	1
65	A7, A10 and Star Twin	2-3525	Oil pump driving spindle washer	1
66	A7, A10 and Star Twin	67-1389	Oil pump driving spindle	1
67	A7, A10 and Star Twin	67-1388	Oil pump driving spindle housing	1
68	A7, A10 and Star Twin	67-1383	Oil pump feed gear (Driver)	1
69	A7, A10 and Star Twin	67-1384	Oil pump feed gear (Driven)	1
70	A7, A10 and Star Twin	67-1382	Oil pump body	1
71	A7, A10 and Star Twin	2-51	Oil pump end fixing nut	3
72	A7, A10 and Star Twin	29-541	Oil pump end fixing nut washer	3
73	A7, A10 and Star Twin	67-340	Scavenge pipe complete	1
74	A7, A10 and Star Twin	31-222	Scavenge cover fixing stud	4
75	A7, A10 and Star Twin	67-1288	Scavenge cover joint washer	1
76	A7, A10 and Star Twin	67-1285	Scavenge cover complete	1
77	A7, A10 and Star Twin	29-541	Scavenge cover fixing nut washer	4
78	A7, A10 and Star Twin	2-51	Scavenge cover fixing stud nut	4
79	A7, A10 and Star Twin	67-1280	Scavenge pipe fixing bolt	1
80	A7, A10 and Star Twin	67-1281	Scavenge pipe fixing bolt lockwasher	1
81	A7, A10 and Star Twin	67-1391	Oil pump end plate	1
82	A7, A10 and Star Twin	67-1392	Oil pump end screw	4
83	A7, A10 and Star Twin	67-1466	Oil pipe union joint washer	1
85	A7, A10 and Star Twin	67-1461	Oil pipe union with pipes	1
86	A7, A10 and Star Twin	66-4707	Oil pipe union fixing bolt washer	1
87	A7, A10 and Star Twin	67-1467	Oil pipe union fixing bolt	1
88	A7, A10 and Star Twin	67-2053	Cush drive bearing	1
89	A7, A10 and Star Twin	67-2050	Engine sprocket with sleeve and key	1
90	A7, A10 and Star Twin	67-2055	Cush drive sliding sleeve	1
91	A7, A10 and Star Twin	67-2062	Cush drive spring	1
92	A7, A10 and Star Twin	67-2054	Cush drive bearing nut	1
93	A7, A10 and Star Twin	35-709	Cush drive bearing nut split pin	1
94	A7, A10 and Star Twin	67-1266	Primary chain tensioner adjuster nut	1
95	A7, A10 and Star Twin	67-1268	Primary chain tensioner adjuster screw	1
96	A7, A10 and Star Twin	67-1261	Primary chain tensioner	1
97	A7, A10 and Star Twin	66-3074	Crankcase and primary chain cover dowel	2
98	A7, A10 and Star Twin	67-1702	Primary chain cover joint washer	1
99	A7, A10 and Star Twin	67-1710	Primary chain cover and bottom chainguard screw nut	1
100	A7, A10 and Star Twin	67-1244	Crankcase oil flinger rivet	3
101	A7, A10 and Star Twin	67-1243	Crankcase oil seal washer	1
102	A7, A10 and Star Twin	67-1242	Crankcase oil seal	1
103	A7, A10 and Star Twin	67-1241	Crankcase oil flinger	1
104	A7, A10 and Star Twin	25-7151	Breather pipe clip bolt nut	1
105	A7, A10 and Star Twin	67-923	Breather pipe clip	1
106	A7, A10 and Star Twin	1-4606	Breather pipe clip screw	1
107	A7, A10 and Star Twin	67-922	Breather pipe	1
108	A7, A10 and Star Twin	67-1263	Primary chain tensioner spring plate	1



Plate Ref. Number.	Model.	Part No.	Description.	Number per set.
109	A7, A10 and Star Twin	2-923	Primary chain tensioner stud washer	2
110	A7, A10 and Star Twin	67-1264	Primary chain tensioner stud nut	2
111	A7, A10 and Star Twin	65-8038	Primary chain tensioner stud nut locking wire	1
112	A7, A10 and Star Twin	67-1235	Crankcase connecting stud (Gearbox housing)	2
113	A7, A10 and Star Twin	29-4101	Crankcase connecting stud (bottom, rear)	1
114	A7, A10 and Star Twin	67-1467	Gearbox fixing bolt (crankcase top fixing)	2
115	A7, A10 and Star Twin	67-1262	Primary chain tensioner stud	2
116	A7, A10 and Star Twin	36-382	Crankcase connecting stud washer	13
117	A7, A10 and Star Twin	2-49	Crankcase connecting stud nut	13
118	A7, A10 and Star Twin	67-455	Crankcase with fixed fittings (G/S)	1
	A7 and Star Twin	67-1231	Crankcase with fixed fittings (G/S) (up to 1951)	1
	A10	67-293	Crankcase with fixed fittings (G/S) (up to 1951)	1
119	A7, A10 and Star Twin	66-4707	Crankcase and gearbox stud nut washer	4
120	A7, A10 and Star Twin	21-5104	Crankcase and gearbox stud nut	2
121	A7, A10 and Star Twin	67-1387	Oil pump scavenge gear spindle	1
122	A7, A10 and Star Twin	67-1386	Oil pump scavenge gear (Driven)	1
123	A7, A10 and Star Twin	67-1385	Oil pump scavenge gear (Driver)	1
124	A7, A10 and Star Twin	67-1393	Oil pump body joint washer	1
125	A7, A10 and Star Twin	35-4005	Gearbox fixing stud (crankcase bottom fixing)	2
126	A7, A10 and Star Twin	67-1394	Oil pump end joint washer (small)	1
127	A7, A10 and Star Twin	67-1395	Oil pump fixing stud (long)	2
128	A7, A10 and Star Twin	67-1396	Oil pump fixing stud (short)	1
129	A7, A10 and Star Twin	67-281	Inner timing cover joint washer	1
130	A7, A10 and Star Twin	27-1589	Crankcase and inner timing cover dowel	2
131	A7, A10 and Star Twin	67-353	Dynamo strap stud	2
132	A7, A10 and Star Twin	29-2203	Dynamo strap eyebolt	1
133	A7, A10 and Star Twin	65-2352	Dynamo strap plug	1
134	A7, A10 and Star Twin	67-1876	Dynamo strap	1
135	A7, A10 and Star Twin	29-4662	Dynamo strap saddle washer	1
136	A7, A10 and Star Twin	2-833	Dynamo strap eyebolt nut	1
137	A7, A10 and Star Twin	67-355	Crankcase stud (top) (rear)	1
138	A7, A10 and Star Twin	67-1236	Crankcase dowel	1
139	A7 and Star Twin	67-540	Magneto driving pinion	1

CARBURETTERS AND SETTINGS

MESSRS. AMALGAMATED CARBURETTERS LTD., PERRY BARR, BIRMINGHAM

	A7	A7 Star Twin	A10	A10 Super Flash
Carburetter (Type)	276EU/1DB	276FD/1DB	276ER/1DB	10.T.T.9
Choke Size (inches)	15/16	1	1 1/8	1 1/8
Jet Number	140	160	170	360
Throttle Valve Number	6/4	6/4	6/4	6
Needle Position	4	3	2	4
Needle Jet	.107	.107	.108	9
Engine End Size (inches)	15/16	1 1/8"	1 1/8"	1 1/8"



16
**CLASSIC
 BIKE SPARES**

Plate 3

GEARBOX—"A" GROUP

Plate Ref. Number.	Model.	Part No.	Description.	Number per set.
1	A7, A10 and Star Twin	67-3014	Gearbox with fixed fittings	1
2	A7, A10 and Star Twin	67-3031	Gearbox inner cover joint washer	1
3	A7, A10 and Star Twin	67-3027	Gearbox inspection hole plug	2
4	A7, A10 and Star Twin	67-3112	Selector cam plate bearing washer	1
5	A7, A10 and Star Twin	67-3137	Selector cam plate bearing	1
6	A7, A10 and Star Twin	29-541	Selector cam plate bearing washer	2
7	A7, A10 and Star Twin	21-5842	Selector cam plate bearing screw	2
8	A7, A10 and Star Twin	67-3266	Clutch cover bolt nut	12
9	A7, A10 and Star Twin	29-3319	Clutch cover bolt nut washer	12
10	A7, A10 and Star Twin	67-3264	Clutch cover washer	1
11	A7, A10 and Star Twin	67-3263	Clutch cover	1
12	A7, A10 and Star Twin	67-3249	Clutch spring adjusting nut	6
13	A7, A10 and Star Twin	67-3247	Clutch spring	6
14	A7, A10 and Star Twin	67-3248	Clutch spring cup	6
15	A7, A10 and Star Twin	67-3245	Clutch spring plate	1
16	A7, A10 and Star Twin	67-3241	Clutch driven plate	5
17	A7, A10 and Star Twin	67-3242	Clutch driving plate	5
18	A7, A10 and Star Twin	67-3244	Clutch driving plate insert	120
19	A7, A10 and Star Twin	67-3240	Clutch driven plate (rear)	1
20	A7, A10 and Star Twin	67-3257	Clutch centre and mainshaft nut	1
21	A7, A10 and Star Twin	67-3253	Clutch centre and mainshaft nut washer	1
22	A7, A10 and Star Twin	67-3237	Clutch centre complete	1
23	A7, A10 and Star Twin	67-3271	Clutch chainwheel complete	1
24	A7, A10 and Star Twin	26-650	Clutch chainwheel rollers	18
25	A7, A10 and Star Twin	67-3276	Clutch thrust washer (.122in.-.126in.)	-
		67-3277	Clutch thrust washer (.138in.-.140in.)	-
		67-3278	Clutch thrust washer (.148in.-.150in.)	-
26	A7, A10 and Star Twin	67-3053	Gearbox sprocket nut	1
27	A7, A10 and Star Twin	24-4263	Gearbox sprocket locking washer	1
28	A7 and Star Twin	67-3064	Gearbox sprocket (18T) (Standard)	1
	A7 and Star Twin	67-3065	Gearbox sprocket (19T)	1
	A10	67-3065	Gearbox sprocket (19T) (Standard)	1
29	A7, A10 and Star Twin	65-3391	Speedometer driven gear bush nut	1
30	A7, A10 and Star Twin	65-3392	Speedometer driven gear bush washer	1
31	A7, A10 and Star Twin	65-3390	Speedometer driven gear bush	1
32	A7, A10 and Star Twin	65-3375	Speedometer driven gear thrust washer	1
33	A7, A10 and Star Twin	67-3175	Speedometer driven gear	1
34	A7, A10 and Star Twin	65-3377	Speedometer gear bush	1
35	A7, A10 and Star Twin	35-702	Clutch push rod lever nut split pin	1
36	A7, A10 and Star Twin	15-1485	Clutch push rod lever nut	1
37	A7, A10 and Star Twin	2-525	Clutch push rod lever washer	1
38	A7, A10 and Star Twin	3-720	Clutch push rod lever adjusting screw nut	1
39	A7, A10 and Star Twin	65-3403	Clutch push rod adjustment screw	1
40	A7, A10 and Star Twin	65-3360	Clutch push rod lever	1
41	A7, A10 and Star Twin	67-3180	Clutch operating lever	1
42	A7, A10 and Star Twin	67-3140	Gearchange lever spindle bush	1
43	A7, A10 and Star Twin	67-3147	Gear selector lever spindle	1
44	A7, A10 and Star Twin	67-3143	Gear selector lever	1
45	A7, A10 and Star Twin	67-3146	Selector lever return spring	2
46	A7, A10 and Star Twin	67-3145	Selector lever screw lockwasher	1
47	A7, A10 and Star Twin	67-3144	Selector lever screw	1
		67-3130	Gearchange selector arm complete	1
48	A7, A10 and Star Twin	67-3131	Gearchange selector arm only	1
49	A7, A10 and Star Twin	67-3133	Gearchange selector arm claw pivot	1
50	A7, A10 and Star Twin	67-3170	Footchange lever spindle bush	1
51	A7, A10 and Star Twin	67-3135	Gearchange selector arm plunger spring	1
52	A7, A10 and Star Twin	67-3134	Gearchange selector arm plunger	1
53	A7, A10 and Star Twin	67-3132	Gearchange selector arm claw	1
54	A7, A10 and Star Twin	67-3136	Gearchange selector arm pivot pin	1
55	A7, A10 and Star Twin	67-3113	Gear control cam plate	1
56	A7, A10 and Star Twin	67-3204	Gear shifter fork	2
57	A7, A10 and Star Twin	67-3017	Gearbox inner cover with fixed fittings	1
58	A7, A10 and Star Twin	67-3191	Mainshaft gear (16T)	1
59	A7, A10 and Star Twin	67-3202	Mainshaft sliding gear (24T)	1
60	A7, A10 and Star Twin	67-3116	Gear shifter fork shaft	1
61	A7, A10 and Star Twin	67-3117	Gear shifter fork shaft grub screw	1
62	A7, A10 and Star Twin	67-3201	Mainshaft sliding gear (20T)	1
63	A7, A10 and Star Twin	67-3192	Constant mesh gear complete with bushes	1
64	A7, A10 and Star Twin	67-3080	Constant mesh gear hush (drilled)	1
65	A7, A10 and Star Twin	67-3073	Constant mesh gear bush (plain)	1
66	A7, A10 and Star Twin	24-4065	Constant mesh gear ball bearing	1
67	A7, A10 and Star Twin	67-3067	Gearbox sprocket oil seal	1

Gearbo



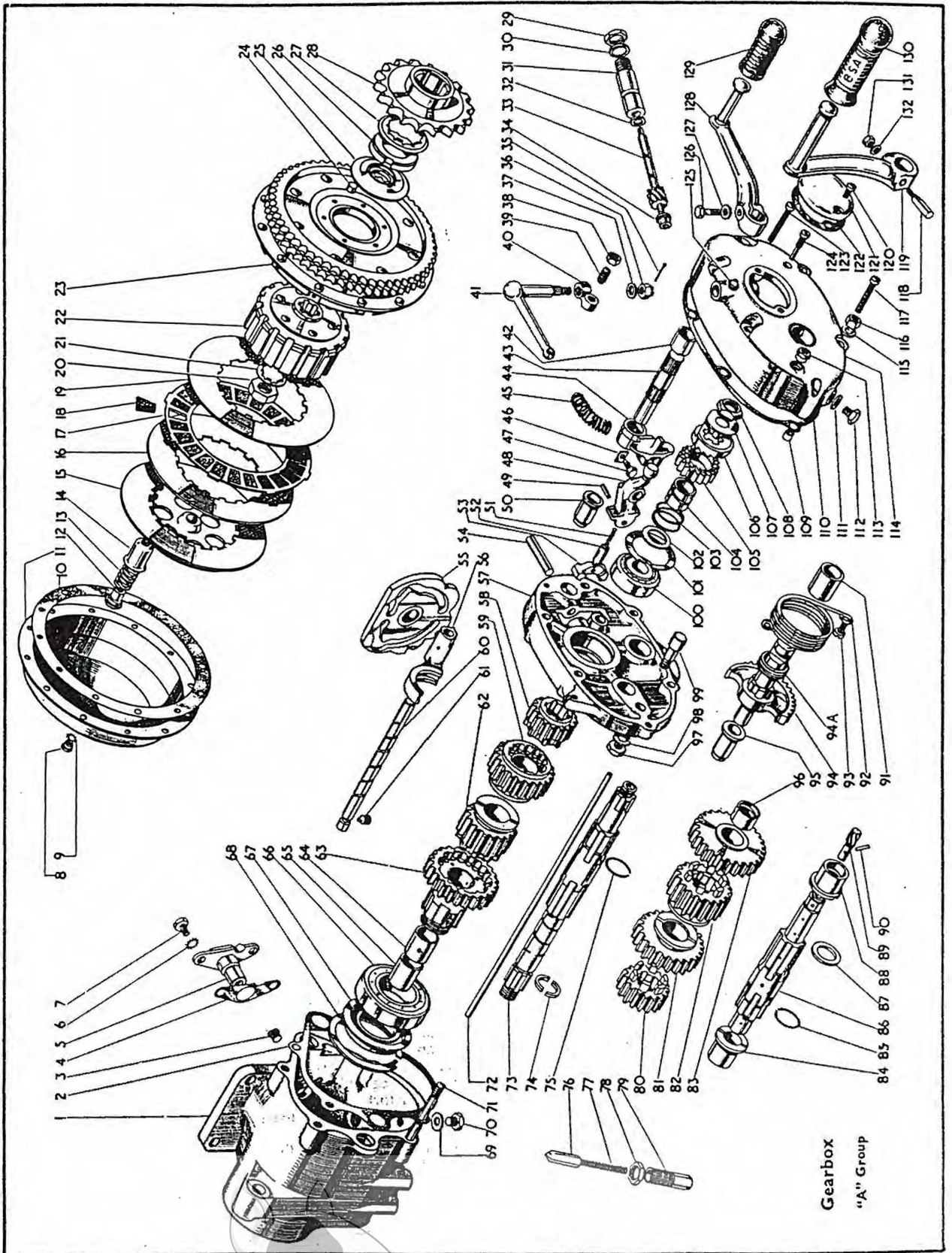

Gearbox
"A" Group

Plate 3—continued

GEARBOX—"A" GROUP

Plate Ref. Number.	Model.	Part No.	Description.	Number per set.
68	A7, A10 and Star Twin	67-3026	Ball bearing spring ring ..	1
69	A7, A10 and Star Twin	2-4553	Gearbox drain plug washer ..	1
70	A7, A10 and Star Twin	28-243	Gearbox drain plug	1
71	A7, A10 and Star Twin	67-3023	Gearbox outer cover stud ..	4
72	A7, A10 and Star Twin	67-3183	Clutch push rod ..	1
73	A7, A10 and Star Twin	67-3061	Gearbox mainshaft only ..	1
		67-3190	Gearbox mainshaft complete with gear ..	1
74	A7, A10 and Star Twin	67-3251	Clutch thrust washer abutment ring ..	1
75	A7, A10 and Star Twin	67-3101	Mainshaft gear locating ring ..	1
76	A7, A10 and Star Twin	67-3119	Gear control cam plate plunger ..	1
77	A7, A10 and Star Twin	67-3121	Gear control cam plate plunger spring ..	1
78	A7, A10 and Star Twin	67-3122	Gear control cam plate plunger housing nut ..	1
79	A7, A10 and Star Twin	67-3120	Gear control cam plate plunger housing ..	1
80	A7, A10 and Star Twin	67-3196	Layshaft gear (17T) ..	1
81	A7, A10 and Star Twin	67-3197	Layshaft sliding gear (23T) ..	1
82	A7, A10 and Star Twin	67-3198	Layshaft sliding gear (19T) ..	1
83	A7, A10 and Star Twin	67-3199	Layshaft gear complete ..	1
84	A7, A10 and Star Twin	65-3337	Layshaft bush ..	1
85	A7, A10 and Star Twin	67-3101	Layshaft gear locating ring ..	1
86	A7, A10 and Star Twin	67-3195	Layshaft only ..	1
		67-3194	Layshaft complete with gears ..	1
87	A7, A10 and Star Twin	67-3203	Layshaft thrust washer ..	1
88	A7, A10 and Star Twin	67-3099	Layshaft bush ..	1
89	A7, A10 and Star Twin	67-3088	Speedometer driving gear (6T) ..	1
90	A7, A10 and Star Twin	67-3128	Speedometer driving gear peg ..	1
91	A7, A10 and Star Twin	67-3153	Kickstart lever spindle bush ..	1
92	A7, A10 and Star Twin	67-3174	Kickstarter spring ..	1
93	A7, A10 and Star Twin	2-3718	Kickstarter spring screw ..	1
94	A7, A10 and Star Twin	67-3178	Kickstart spindle and quadrant ..	1
94A	A7, A10 and Star Twin	67-3173	Kickstart spindle sleeve ..	1
95	A7, A10 and Star Twin	67-3151	Kickstart spindle bush ..	1
96	A7, A10 and Star Twin	67-3093	Layshaft gear bush ..	1
97	A7, A10 and Star Twin	2-49	Kickstarter quadrant stop nut ..	1
98	A7, A10 and Star Twin	24-8784	Kickstarter quadrant stop washer ..	1
99	A7, A10 and Star Twin	67-3152	Kickstart quadrant stop ..	1
100	A7, A10 and Star Twin	24-4217	Mainshaft bearing ..	1
101	A7, A10 and Star Twin	67-3028	Mainshaft bearing spring ring ..	1
102	A7, A10 and Star Twin	67-3161	Kickstart ratchet pinion sleeve washer ..	1
103	A7, A10 and Star Twin	67-3162	Kickstart ratchet spring ..	1
104	A7, A10 and Star Twin	67-3169	Kickstart ratchet pinion bush ..	1
105	A7, A10 and Star Twin	67-3168	Kickstart ratchet pinion ..	1
106	A7, A10 and Star Twin	67-3167	Kickstart ratchet ..	1
107	A7, A10 and Star Twin	67-3164	Kickstart ratchet and mainshaft lockwasher ..	1
108	A7, A10 and Star Twin	67-3163	Kickstart ratchet and mainshaft nut ..	1
109	A7, A10 and Star Twin	66-3074	Gearbox cover dowel ..	2
110	A7, A10 and Star Twin	67-3032	Gearbox outer cover joint washer ..	1
111	A7, A10 and Star Twin	2-4553	Oil level plug washer ..	1
112	A7, A10 and Star Twin	28-243	Oil level plug ..	1
113	A7, A10 and Star Twin	27-4401	Kickstarter spring screw locknut ..	1
114	A7, A10 and Star Twin	67-3021	Gearbox outer cover with fixed fittings ..	1
115	A7, A10 and Star Twin	2-923	Gearbox outer cover fixing washer ..	4
116	A7, A10 and Star Twin	67-3034	Gearbox outer cover fixing nut ..	4
117	A7, A10 and Star Twin	67-1705	Gearbox outer cover fixing screw (short) ..	1
118	A7, A10 and Star Twin	2-2579	Kickstarter crank cotter ..	1
119	A7, A10 and Star Twin	65-3381	Kickstarter crank ..	1
120	A7, A10 and Star Twin	24-7178	Gearbox inspection cover screw ..	2
121	A7, A10 and Star Twin	67-3024	Gearbox inspection cover ..	1
122	A7, A10 and Star Twin	67-3033	Gearbox inspection cover joint washer ..	1
123	A7, A10 and Star Twin	67-1706	Gearbox outer cover fixing screw (long) ..	2
124	A7, A10 and Star Twin	67-3176	Speedometer driven gear retaining pin ..	1
125	A7, A10 and Star Twin	28-2080	Gearbox outer cover grease nipple ..	1
126	A7, A10 and Star Twin	65-3361	Selector lever foot operating screw ..	1
127	A7, A10 and Star Twin	2-525	Foot operating lever screw washer ..	1
128	A7, A10 and Star Twin	65-3417	Gear change operating lever ..	1
129	A7, A10 and Star Twin	29-3250	Footchange operating lever rubber ..	1
130	A7, A10 and Star Twin	65-3397	Kickstart crank rubber ..	1
131	A7, A10 and Star Twin	2-2578	Kickstart crank cotter nut ..	1
132	A7, A10 and Star Twin	15-5155	Kickstart crank cotter washer ..	1



CLASSIC
BIKE SPARES

Plate Ref. Number.	Model.	Part No.	Description.	Number per set.
1	A7, A10 and Star Twin	67-4038	Gearbox foot set screw locking wire (4in.)	1
2	A7, A10 and Star Twin	67-4028	Gearbox foot set screw	2
3	A7, A10 and Star Twin	36-382	Gearbox foot set screw washer (shakeproof)	2
4	A7, A10 and Star Twin	67-4848	Central stand pin	2
5	A7, A10 and Star Twin	28-2080	Central stand pin grease nipple	2
6	A7, A10 and Star Twin	35-698	Central stand split pin	2
7	A7, A10 and Star Twin	67-4029	Footrest stud (offside)	1
	A7, A10 and Star Twin	67-4041	Footrest stud (nearside)	1
8	A7, A10 and Star Twin	67-4851	Footrest bracket	2
9	A7, A10 and Star Twin	67-4852	Footrest bracket nut complete (offside)	1
	A7, A10 and Star Twin	67-4856	Footrest bracket nut complete (nearside)	1
10	A7, A10 and Star Twin	29-7551	Footrest Rubber	2
11	A7, A10 and Star Twin	2-46	Crankcase and exhaust pipe lug stud nut	2
12	A7, A10 and Star Twin	66-4707	Crankcase and exhaust pipe lug stud washer (shakeproof)	2
13	A7, A10 and Star Twin	67-1251	Crankcase and exhaust pipe lug stud (solo machines)	1
14	A7, A10 and Star Twin	27-6275	Crankcase and exhaust pipe lug stud (when sidecar fitted)	1
15	A7, A10 and Star Twin	67-4173	Front engine plate complete (offside)	1
15A	A7, A10 and Star Twin	67-4026	Front engine support bolt	1
16	A7, A10 and Star Twin	24-5160	Engine steady stay bolt nut	1
16A	A7, A10 and Star Twin	36-382	Engine steady stay bolt washer (shakeproof)	1
17	A7, A10 and Star Twin	2-923	Engine steady stay bolt washer (plain)	1
17A	A7, A10 and Star Twin	28-2080	Ball head grease nipple	1
18	A7, A10 and Star Twin	67-4056	Frame front complete	1
18A	A7, A10 and Star Twin	32-194	Engine steady stay bolt	1
19	A7, A10 and Star Twin	67-4036	Engine plate insert complete	1
20	A7, A10 and Star Twin	67-4171	Front engine plate complete (nearside)	1
21	A7, A10 and Star Twin	66-4708	Front engine support bolt washer (shakeproof)	1
22	A7, A10 and Star Twin	2-440	Front engine support bolt nut	1
23	A7, A10 and Star Twin	2-46	Saddle front pivot bolt nut	1
24	A7, A10 and Star Twin	66-4707	Saddle front pivot bolt washer (shakeproof)	1
25	A7, A10 and Star Twin	66-4708	Backstay and seat lug washer (shakeproof)	1
26	A7, A10 and Star Twin	28-2080	Saddle pivot grease nipple	1
27	A7, A10 and Star Twin	67-4030	Saddle front pivot bolt	1
28	A7, A10 and Star Twin	15-7161	Carrier fixing screw	4
29	A7, A10 and Star Twin	67-6921	Carrier complete	1
30	A7, A10 and Star Twin	2-1462	Carrier fixing screw washer (spring)	4
31	A7, A10 and Star Twin	2-2395	Carrier fixing screw nut	4
32	A7, A10 and Star Twin	66-4175	Backstay and seat lug stud	1
33	A7, A10 and Star Twin	2-1945	Backstay and seat lug stud washer	2
34	A7, A10 and Star Twin	15-541	Backstay and seat lug stud nut	2
35	A7, A10 and Star Twin	2-49	Saddle rear fixing stud nut	4
36	A7, A10 and Star Twin	2-923	Saddle rear fixing stud washer	4
37	A7, A10 and Star Twin	67-4040	Saddle rear fixing stud	2
38	A7, A10 and Star Twin	67-4130	Lifting handle	1
39	A7, A10 and Star Twin	31-68	Plunger column bolt (top)	2
40	A7, A10 and Star Twin	66-4707	Plunger column bolt washer (top) (shakeproof)	2
41	A7, A10 and Star Twin	2-46	Plunger column bolt nut (top)	2
42	A7, A10 and Star Twin	2-1946	Sidecar chainstay lug stud nut	1
43	A7, A10 and Star Twin	35-722	Sidecar chainstay lug stud split pin	2
44	A7, A10 and Star Twin	67-4120	Sidecar chainstay lug stud	1
45	A7, A10 and Star Twin	67-4094	Chainstay and backstay complete	1
	A7, A10, Rigid Frame	67-4070	Chainstay and backstay complete (up to 1951)	1
	A7, A10, Rigid Frame	67-4102	Chainstay and backstay complete (up to 1953)	1
46	A7, A10 and Star Twin	2-49	Plunger carrier and bottom clip and silencer support bolt nut	2
47	A7, A10 and Star Twin	36-382	Plunger carrier and bottom clip and silencer support bolt washer (shakeproof)	2
48	A7, A10 and Star Twin	67-4128	Plunger carrier and bottom clip and silencer support bolt	2
49	A7, A10 and Star Twin	66-4707	Plunger carrier and bottom clip bolt washer (shakeproof)	2
50	A7, A10 and Star Twin	67-4129	Plunger carrier and bottom clip and silencer support bolt distance washer	2
51	A7, A10 and Star Twin	2-46	Plunger carrier and bottom clip bolt nut	2
52	A7, A10 and Star Twin	2-46	Pillion footrest anchor bolt nut	2
53	A7, A10 and Star Twin	2-2903	Pillion footrest anchor bolt washer (spring)	2
54	A7, A10 and Star Twin	67-4122	Sidecar chainstay lug stud locknut	1
55	A7, A10 and Star Twin	15-518	Rear brake pedal pinch bolt	1
56	A7, A10 and Star Twin	36-382	Rear brake pedal pinch bolt washer (shakeproof)	1
57	A7, A10 and Star Twin	67-7032	Rear brake pedal return spring	1
58	A7, A10 and Star Twin	67-7026	Rear brake pedal complete	1
59	A7, A10 and Star Twin	2-440	Gearbox top fixing bolt nut	1
60	A7, A10 and Star Twin	3-110	Gearbox top fixing bolt washer (spring)	1
61	A7, A10 and Star Twin	67-7027	Rear brake pedal operating lever	1
62	A7, A10 and Star Twin	67-4027	Gearbox top fixing bolt	1



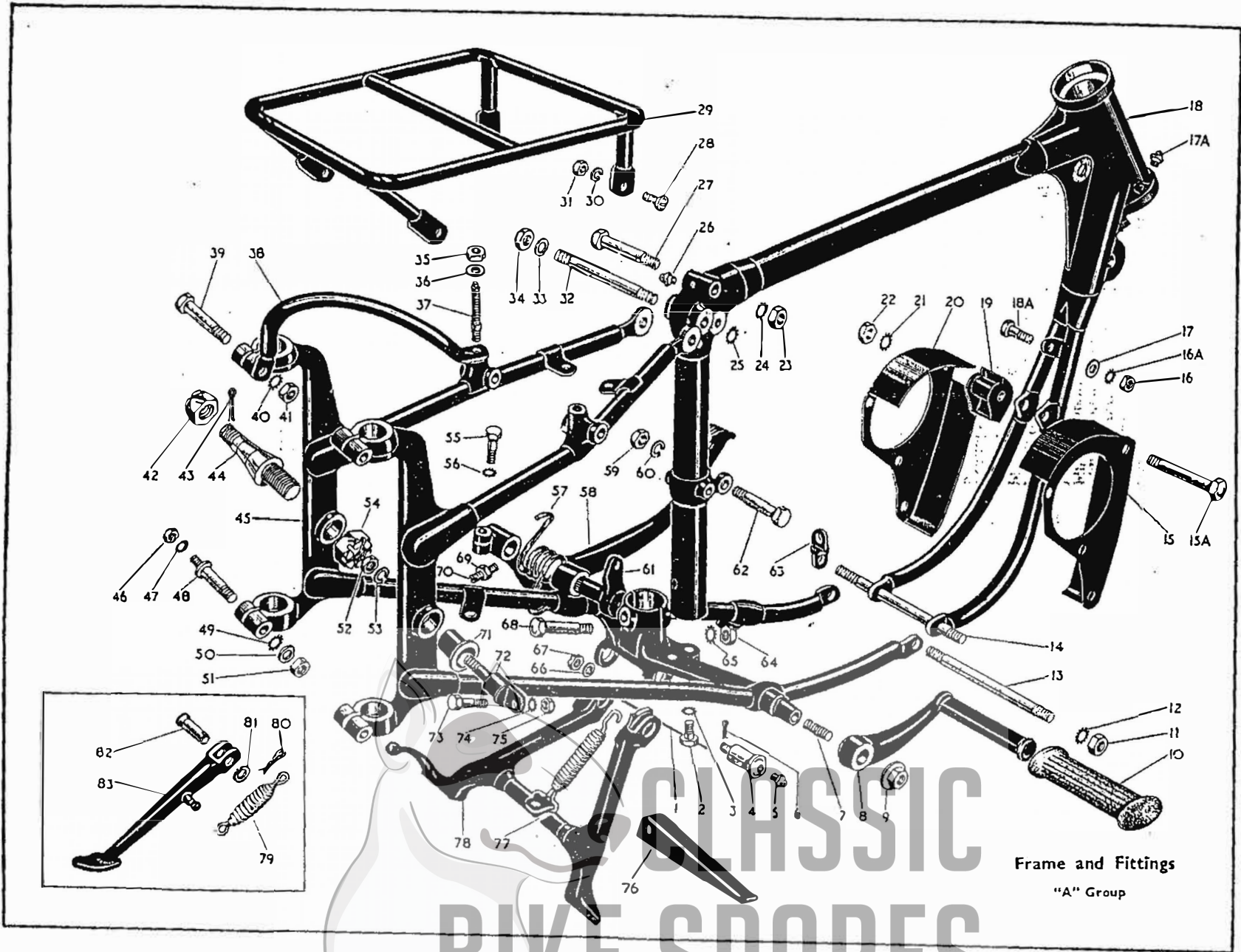

Frame and Fittings
"A" Group

CLASSIC
BIKE SPARES

Plate 4—continued

FRAME AND FITTINGS—"A" GROUP

Plate Ref. Number.	Model.	Part No.	Description.	Number per set.
63	A7, A10 and Star Twin	3-1718	Front bottom connecting link (when sidecar fitted)	1
64	A7, A10 and Star Twin	2-440	Chainstay bridge clamp bolt nut	1
65	A7, A10 and Star Twin	66-4708	Chainstay bridge clamp bolt washer (shakeproof)	1
66	A7, A10 and Star Twin	30-733	Central stand pin washer	2
67	A7, A10 and Star Twin	21-431	Central stand pin nut	2
68	A7, A10 and Star Twin	67-4027	Chainstay bridge clamp bolt	1
69	A7, A10 and Star Twin	2-2395	Rear brake pedal adjusting screw nut	1
70	A7, A10 and Star Twin	67-7037	Rear brake pedal adjusting screw	1
71	A7, A10 and Star Twin	67-4183	Pillion footrest adaptor (solo)	2
	A7, A10 and Star Twin	67-4183	Pillion footrest adaptor (sidecar)	1
72	A7, A10 and Star Twin	29-7560	Pillion footrest anchor bolt	2
73	A7, A10 and Star Twin	29-7564	Pillion footrest swivel bolt	2
74	A7, A10 and Star Twin	36-382	Pillion footrest swivel bolt washer (shakeproof)	2
75	A7, A10 and Star Twin	24-6040	Pillion footrest swivel bolt nut	2
76	A7, A10 and Star Twin	29-7561	Pillion footrest complete	2
77	A7, A10 and Star Twin	67-4847	Central stand spring	1
78	A7, A10 and Star Twin	67-4816	Central stand complete	1
79	A7, A10 and Star Twin	65-4742	Prop stand spring	1
80	A7, A10 and Star Twin	35-710	Prop stand split pin	1
81	A7, A10 and Star Twin	2-1945	Prop stand pivot pin washer	1
82	A7, A10 and Star Twin	67-4907	Prop stand pivot pin	1
83	A7, A10 and Star Twin	67-4903	Prop stand leg	1
	A7, A10 and Star Twin	67-4902	Prop stand assembly	1
	A7, A10 and Star Twin	67-4879	Prop stand assembly (up to 1953)	1

Plate 5

REAR SUSPENSION—"A" GROUP

Plate Ref. Number.	Model.	Part No.	Description.	Number per set.
1	A7, A10 and Star Twin	67-4166	Plunger carrier column screw plug	2
2	A7, A10 and Star Twin	89-4041	Plunger carrier column assembly	2
3	A7, A10 and Star Twin	89-4248	Plunger spring outer shroud	2
4	A7, A10 and Star Twin	89-4249	Plunger spring inner shroud	2
5	A7, A10 and Star Twin	89-4257	Plunger spring top collar	2
6	A7, A10 and Star Twin	67-4132	Plunger spring (top)	2
	A7, A10 and Star Twin	89-4247	Plunger Spring (top) (sidecar)	2
7	A7, A10 and Star Twin	66-4707	Clamp lug bolt washer (shakeproof)	2
8	A7, A10 and Star Twin	89-4046	Plunger tube with bushes	2
9	A7, A10 and Star Twin	3-1399	Clamp lug bolt	2
10	A7, A10 and Star Twin	28-2080	Rear spindle clamp lug grease nipple	2
11	A7, A10 and Star Twin	67-4125	Rear spindle clamp lug (nearside)	1
11	A7, A10 and Star Twin	67-4126	Rear spindle clamp lug (offside)	1
12	A7, A10 and Star Twin	89-4240	Rebound spring shroud (outer)	2
13	A7, A10 and Star Twin	89-4241	Rebound spring shroud (inner)	2
14	A7, A10 and Star Twin	89-4258	Rebound spring bottom collar	2
15	A7, A10 and Star Twin	89-4259	Rebound spring (bottom)	2
16	A7, A10 and Star Twin	2-46	Clamp lug bolt nut	2
17	A7, A10 and Star Twin	15-1312	Rear wheel adjusting screw spring	2
18	A7, A10 and Star Twin	66-4603	Rear wheel adjusting screw	2
19	A7, A10 and Star Twin	67-4127	Rebound spring top collar	2



REAR SUSPENSION—"A" GROUP

Rear Suspension
"A" Group

Rear
Suspensi

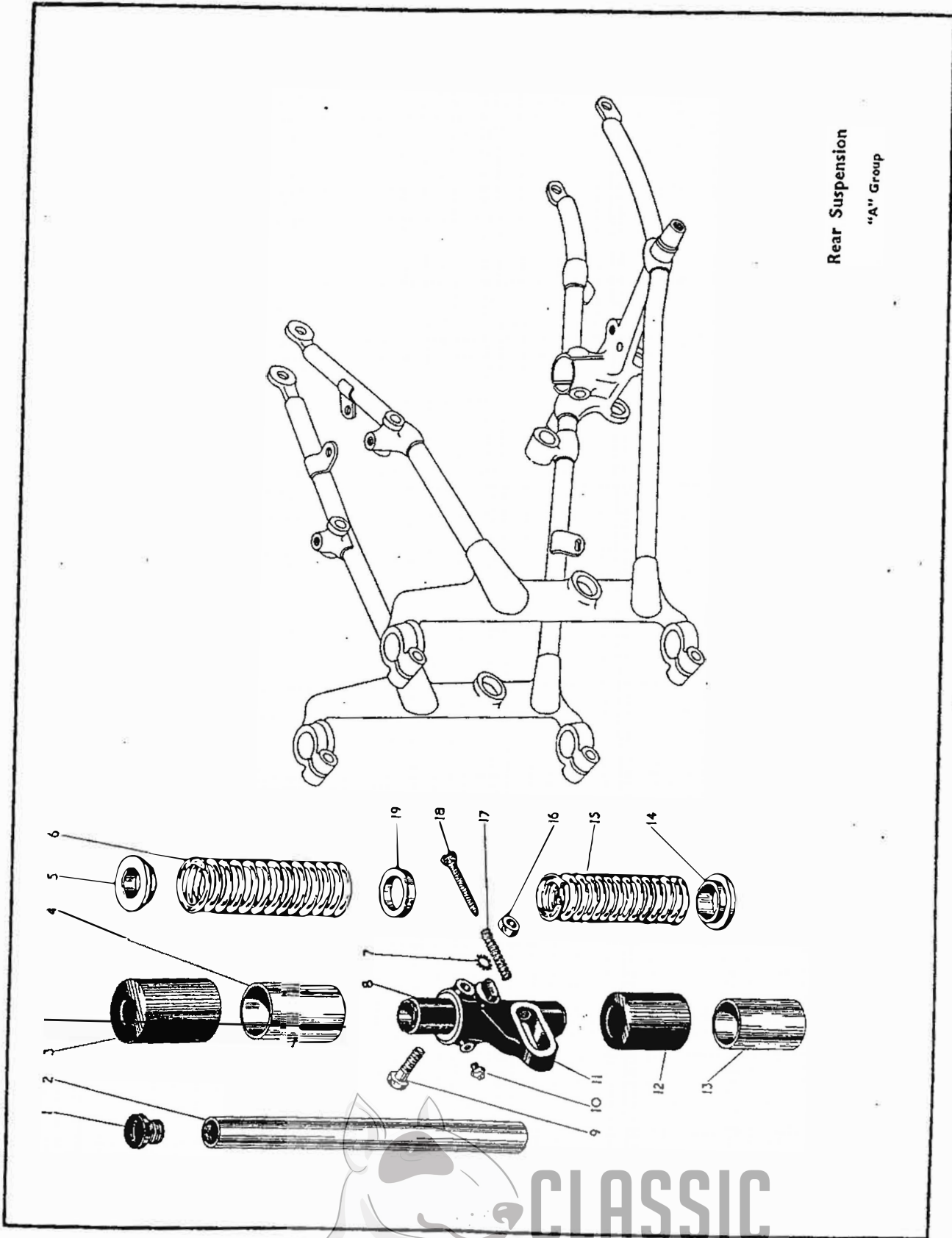
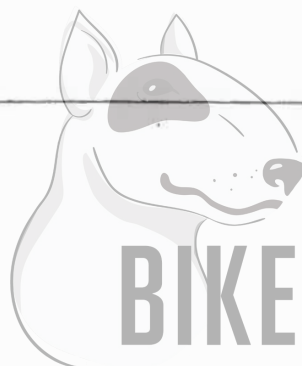
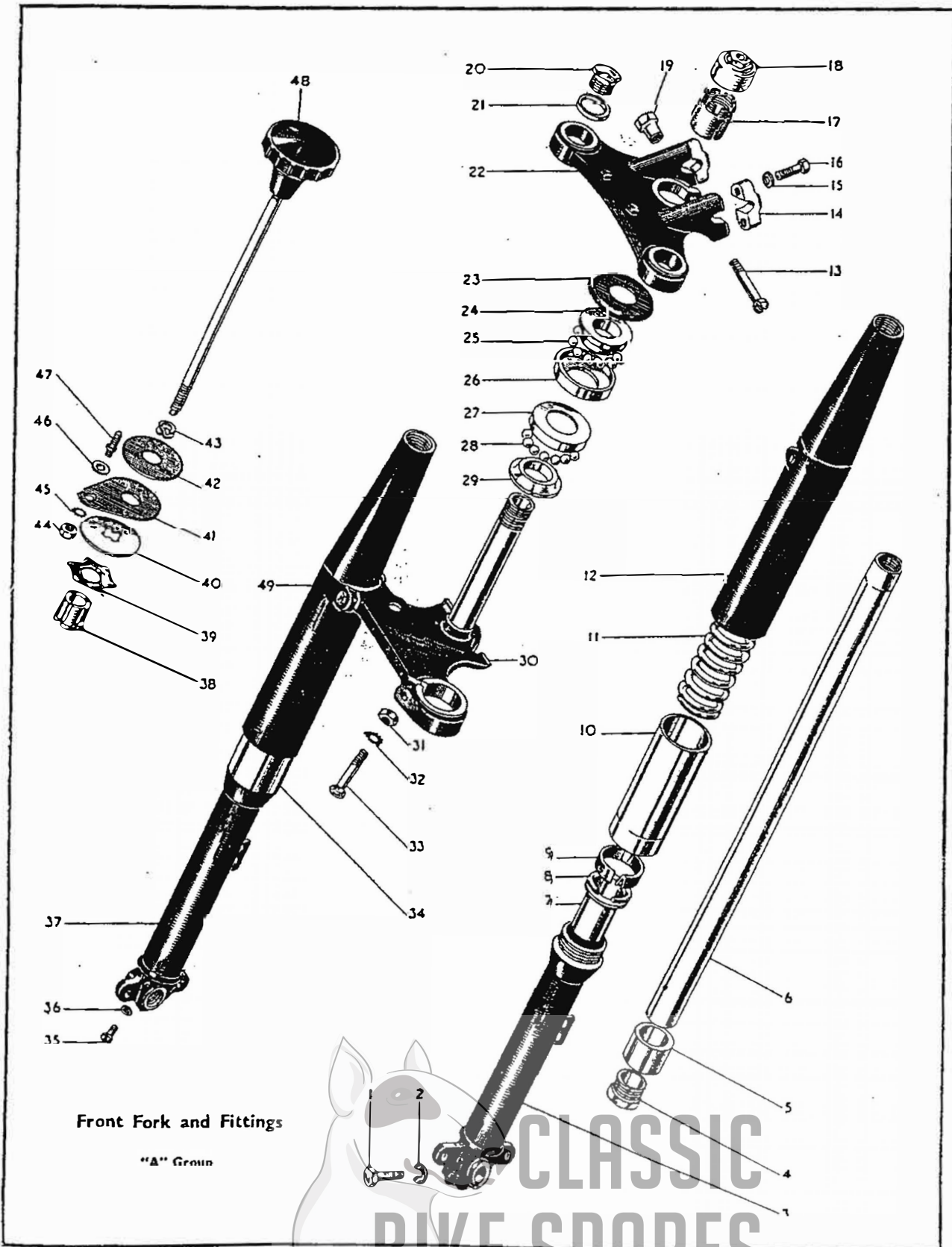

Plate Ref. Number	Model.	Part No.	Description.	Number per set.
	A7, A10 and Star Twin	67-5077	Front fork complete	1
	A7 and Star Twin	65-5400	Front fork complete (up to 1951)	1
	A7	67-5054	Front fork complete (up to 1952)	1
	Star Twin	67-5060	Front fork complete (up to 1952)	1
	A10	67-5049	Front fork complete (up to 1952)	1
1	A7, A10 and Star Twin	65-5295	Fork end bolt (N/S)	1
2	A7, A10 and Star Twin	2-2903	Fork end bolt washer (spring)	1
3	A7, A10 and Star Twin	67-5057	Front fork sliding tube (N/S)	1
	A7	65-5408	Front fork sliding tube (N/S) (up to 1953)	1
	Star Twin	65-5408	Front fork sliding tube (N/S) (up to 1951)	1
4	A7, A10 and Star Twin	29-5283	Fork shaft plug	2
5	A7, A10 and Star Twin	29-5347	Fork bottom bearing	2
6	A7, A10 and Star Twin	89-5061	Fork shaft	2
7	A7, A10 and Star Twin	65-5424	Fork top bearing	2
8	A7, A10 and Star Twin	29-5320	Fork top bearing circlip	2
9	A7, A10 and Star Twin	29-5313	Fork oil seal	2
10	A7, A10 and Star Twin	29-5310/3	Fork oil seal holder complete	1
11	A7, A10 and Star Twin	65-5391	Fork spring (sidocar machines)	2
		89-5036	Fork spring (solo machines)	2
12	A7, A10 and Star Twin	67-5009	Fork outer sleeve (N/S)	1
	A7, A10 and Star Twin	67-5042	Fork outer sleeve (N/S) (up to 1953)	1
13	A7, A10 and Star Twin	27-5135	Fork top yoke clip bolt	1
14	A7, A10 and Star Twin	65-5333	Handlebar clip	2
15	A7, A10 and Star Twin	15-5155	Handlebar clip bolt washer	4
16	A7, A10 and Star Twin	65-5334	Handlebar clip bolt	4
17	A7, A10 and Star Twin	67-5023	Steering stem adjusting sleeve	1
18	A7, A10 and Star Twin	67-5024	Steering stem adjusting sleeve cap	1
19	A10	66-5097	Fork top yoke clip bolt nut	1
	A7 and Star Twin	29-5315	Fork top yoke clip bolt nut	1
20	A7, A10 and Star Twin	65-5331	Fork tube nut	2
21	A7, A10 and Star Twin	65-5332	Fork tube nut washer	2
22	A7, A10 and Star Twin	65-5430	Fork top yoke	1
	A7, A10 and Star Twin	66-5088	Fork top yoke (up to 1953)	1
23	A7, A10 and Star Twin	66-5203	Steering head dust cap	1
24	A7, A10 and Star Twin	65-5126	Steering head ballrace cone (top)	1
25	A7, A10 and Star Twin	1in. diam.	Steering head balls	20
26	A7, A10 and Star Twin	66-4149	Ball head cup	1
27	A7, A10 and Star Twin	66-4149	Ball head cup	1
28	A7, A10 and Star Twin	1in. diam.	Steering head balls	20
29	A7, A10 and Star Twin	65-5127	Steering head ballrace cone (bottom)	1
30	A7, A10 and Star Twin	66-5089	Fork bottom yoke	1
31	A7, A10 and Star Twin	24-5160	Fork bottom yoke bolt nut	2
32	A7, A10 and Star Twin	36-382	Fork bottom yoke bolt washer	1
33	A7, A10 and Star Twin	65-5435	Fork bottom yoke bolt	2
34	A7, A10 and Star Twin	29-5310/3	Fork oil seal holder complete	1
35	A7, A10 and Star Twin	2-1309	Fork end drain plug	2
36	A7, A10 and Star Twin	2-292	Fork end drain plug washer	2
37	A7, A10 and Star Twin	67-5050	Fork sliding tube (O/S)	1
	A7 and Star Twin	65-5410	Fork sliding tube (O/S) (up to 1950)	1
	A7	67-5055	Fork sliding tube (O/S) (up to 1953)	1
38	A7, A10 and Star Twin	65-5328	Steering damper centre	1
39	A7, A10 and Star Twin	25-5247	Steering damper star washer	1
40	A7, A10 and Star Twin	25-5241	Steering damper bottom plate	1
41	A7, A10 and Star Twin	27-5152	Steering damper anchor plate	1
42	A7, A10 and Star Twin	65-5380	Steering damper friction washer	2
43	A7, A10 and Star Twin	24-6035	Steering damper knob spring washer	1
44	A7, A10 and Star Twin	2-49	Steering damper anchor plate stud nut	1
45	A7, A10 and Star Twin	36-382	Steering damper anchor plate stud washer	1
46	A7, A10 and Star Twin	2-923	Steering damper anchor plate stud washer	1
47	A7, A10 and Star Twin	65-5327	Steering damper anchor plate stud	1
48	A7, A10 and Star Twin	67-5021	Steering damper adjusting rod	1
49	A7, A10 and Star Twin	67-5009	Fork outer sleeve (O/S)	1
	A7, A10 and Star Twin	67-5044	Fork outer sleeve (O/S) (up to 1953)	1



FRONT FORK AND FITTINGS—"A" GROUP



Front F
and
Fittings

Front Fork and Fittings
"A" Group

CLASSIC
BIKE SPARES

Plate Ref. Number.	Model.	Part No.	Description.	Number per set.
	A7	67-5542/41	Front wheel complete (less brake and tyre)	1
	Star Twin	67-5542/42	Front wheel complete (less brake and tyre)	1
	A10	67-5542/43	Front wheel complete (less brake and tyre)	1
	A7	67-5538/17	Front wheel complete (less brake and tyre) (up to 1953)	1
	Star Twin	67-5538/19	Front wheel complete (less brake and tyre) (up to 1952)	1
	Star Twin	67-5542/19	Front wheel complete (less brake and tyre) (up to 1953)	1
	A10	67-5542/17	Front wheel complete (less brake and tyre) (up to 1953)	1
	A10	67-5542/26	Front wheel complete (less brake and tyre) (up to 1953)	1
1	A7, A10 and Star Twin	65-5883	Front hub ball journal	1
2	A7, A10 and Star Twin	67-5565	Front hub spindle sleeve	1
3	A7, A10 and Star Twin	67-5547	Front hub complete with spindle and bearings	1
	A7	65-5876	Front hub complete with spindle and bearings (up to 1953)	1
	Star Twin	65-5876	Front hub complete with spindle and bearings (up to 1951)	1
4	A7, A10 and Star Twin	67-5545	Front wheel spoke (long)	20
5	A7, A10 and Star Twin	27-6810	Front wheel spoke nipple	40
6	A7, A10 and Star Twin	65-5883	Front hub ball journal	1
7	A7, A10 and Star Twin	67-5563	Hub bearing oil retaining washer (N/S)	1
8	A7, A10 and Star Twin	67-5561	Hub bearing locking ring (N/S)	1
9	A7, A10 and Star Twin	67-5566	Front hub spindle	1
10	A7, A10 and Star Twin	35-701	Hub bearing locking ring retaining pin	1
11	A7, A10 and Star Twin	15-5290	Front hub grease nipple	1
12	A7, A10 and Star Twin	67-5544	Front wheel spoke (short)	20
13	A7, A10 and Star Twin	35-701	Hub bearing locking ring retaining pin	1
14	A7, A10 and Star Twin	67-5562	Hub bearing locking ring (O/S)	1
15	A7, A10 and Star Twin	67-5575	Brake shoe lining rivet	14
16	A7, A10 and Star Twin	67-5576	Front brake fulcrum and adjusting pin	1
17	A7, A10 and Star Twin	67-5571	Front brake shoe lining	2
18	A7, A10 and Star Twin	67-5555/3	Front brake cover plate with fixed fittings	1
	A7	65-5895/3	Front brake cover plate with fixed fittings (up to 1953)	1
	Star Twin	65-5895/3	Front brake cover plate with fixed fittings (up to 1951)	1
19	A7, A10 and Star Twin	2-49	Front brake anchor strap bolt nut	2
20	A7, A10 and Star Twin	36-382	Front brake anchor strap bolt washer	2
21	A7, A10 and Star Twin	67-5578	Front brake anchor strap	1
22	A7, A10 and Star Twin	32-194	Front brake anchor strap bolt	2
23	A7, A10 and Star Twin	15-716	Front brake cover plate and anchor strap washer	2
24	A7, A10 and Star Twin	15-541	Front brake cover plate and anchor strap nut	1
25	A7, A10 and Star Twin	2-2527	Front brake fulcrum and adjusting pin nut	1
26	A7, A10 and Star Twin	35-37	Front brake fulcrum and adjusting pin washer	1
27	A7, A10 and Star Twin	25-6014	Front brake fulcrum and adjusting pin washer (plain)	1
28	A7, A10 and Star Twin	2-440	Front brake shoe cam nut	1
29	A7, A10 and Star Twin	66-4708	Front brake shoe cam washer	1
30	A7, A10 and Star Twin	65-5907	Front brake operating lever	1
31	A7, A10 and Star Twin	28-2080	Front brake fulcrum pin grease nipple	1
32	A7, A10 and Star Twin	67-5572	Front brake shoe cam	1
33	A7, A10 and Star Twin	65-5904	Front brake shoe spring	2
34	A7, A10 and Star Twin	67-5558	Front brake shoe complete	2
35	A7, A10 and Star Twin	67-5564	Hub bearing oil retaining washer (O/S)	1
36	A7, A10 and Star Twin	67-5543/3	Front wheel rim	1
	A7	65-5871/17	Front wheel rim (up to 1953)	1
	Star Twin	65-5871/19	Front wheel rim (up to 1952)	1
	Star Twin	67-5543/19	Front wheel rim (up to 1953)	1
	A10	67-5543/17	Front wheel rim (up to 1953)	1
	A10	67-5543/26	Front wheel rim (up to 1953)	1



“A” GROUP

Plate Ref. Number.	Model.	Part No.	Description.	Number per set.
	A7	67-6012/41	Rear wheel complete (less brake and tyre)	1
	A10	67-6012/43	Rear wheel complete (less brake and tyre)	1
	A7 Star Twin	67-6012/42	Rear wheel complete (less brake and tyre)	1
1	A7, A10 and Star Twin	2-440	Rear brake operating lever nut	1
2	A7, A10 and Star Twin	66-4708	Rear brake operating lever washer	1
3	A7, A10 and Star Twin	15-431	Rear brake operating lever washer (plain)	1
4	A7, A10 and Star Twin	67-6053	Rear brake operating lever	1
5	A7, A10 and Star Twin	67-6081	Brake lever steady strap	1
6	A7, A10 and Star Twin	65-5674	Cam bearing oil hole clip	1
7	A7, A10 and Star Twin	67-6180/3	Rear brake cover plate	1
	A7, A10 and Star Twin	67-6180/7	Rear brake cover plate	1
8	A7, A10 and Star Twin	65-5905	Rear brake cam	1
9	A7, A10 and Star Twin	65-5901	Rear brake shoe complete	2
10	A7, A10 and Star Twin	35-6436	Shoe lining rivet	14
11	A7, A10 and Star Twin	65-5903	Brake shoe lining	2
12	A7, A10 and Star Twin	67-6078	Hub collar (L/H)	1
13	A7, A10 and Star Twin	67-9045	Rear driving chain (sidecar)	1
	A7 and Star Twin	67-9041	Rear driving chain (solo)	1
	A10	67-9046	Rear driving chain (solo)	1
14	A7, A10 and Star Twin	89-3022	Brake drum and chainwheel bearing	1
15	A7, A10 and Star Twin	67-6072	Ball bearing shim	1
16	A7, A10 and Star Twin	67-6067	Ball bearing retaining ring	1
17	A7, A10 and Star Twin	67-6076	Bearing locking ring	1
18	A7, A10 and Star Twin	65-6303	Wheel spoke (N/S)	20
19	A7, A10 and Star Twin	15-5290	Hub grease nipple	1
20	A7, A10 and Star Twin	67-6126	Hub shell complete with bearing	1
21	A7, A10 and Star Twin	65-5883	Rear hub ball bearing	1
22	A7, A10 and Star Twin	67-6077	Hub collar (R/H)	1
23	A7, A10 and Star Twin	67-6076	Bearing locking ring	1
24	A7, A10 and Star Twin	67-6075	Rear hub washer (felt)	1
25	A7, A10 and Star Twin	67-6128	Rear hub shell cover	1
26	A7, A10 and Star Twin	67-6066	Rear hub distance piece (R/H)	1
27	A7, A10 and Star Twin	67-6051	Rear hub shell washer (rubber)	1
28	A7, A10 and Star Twin	67-6061	Bearing distance tube and retainers	1
29	A7, A10 and Star Twin	65-5884	Hub bearing thrust washer	1
30	A7, A10 and Star Twin	65-5883	Rear hub ball bearing	1
31	A7, A10 and Star Twin	67-6038	Brake drum securing bolt	6
32	A7, A10 and Star Twin	27-6813	Rear wheel spoke nipple	40
33	A7, A10 and Star Twin	65-6302	Wheel spoke (O/S)	20
34	A7, A10 and Star Twin	67-6164	Rear hub spindle	1
35	A7	67-6005/41	Rear wheel rim	1
	A10	67-6005/43	Rear wheel rim	1
	A7 and Star Twin	67-6005/42	Rear wheel rim	1
36	A7, A10 and Star Twin	67-6060	Rear hub bearing sleeve	1
37	A7, A10 and Star Twin	67-6101	Driving flange	1
38	Star Twin	67-6154	Brake drum and chainwheel (solo)	1
	A7, A10 and Star Twin	67-6124	Brake drum and chainwheel (sidecar)	1
	A7	67-6123	Brake drum and chainwheel (solo)	1
	A10	67-6150	Brake drum and chainwheel (solo)	1
39	A7, A10 and Star Twin	67-6039	Brake drum securing bolt lock strip	3
40	A7, A10 and Star Twin	3-720	Brake drum securing bolt nut	6
41	A7, A10 and Star Twin	65-5904	Rear brake spring	2
42	A7, A10 and Star Twin	65-5899	Rear brake fulcrum pin	1
43	A7, A10 and Star Twin	24-8045	Rear brake fulcrum washer (serrated)	1
44	A7, A10 and Star Twin	24-5860	Rear brake fulcrum pin nut	1
45	A7, A10 and Star Twin	67-6074	Rear hub bearing sleeve nut	1
46	A7, A10 and Star Twin	67-6073	Rear hub spindle nut	1

3-7-9.

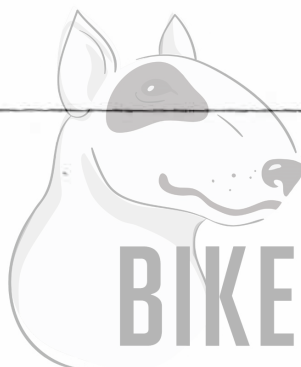

Plate 8

ACCESSORIES—"A" GROUP

A7, A10 and Star Twin

Plate Ref. Number.	Model.	Part No.	Description.	Number per set.
1	A7, A10 and Star Twin	24-8784	Chainguard to crankcase fixing bolt washer (spring)	1
2	A7, A10 and Star Twin	21-2880	Chainguard to crankcase fixing bolt	1
3	A7, A10 and Star Twin	65-8422	Oil return pipe connection ferrule	1
4	A7, A10 and Star Twin	65-2060	Oil return pipe connection (rubber)	1
5	A7, A10 and Star Twin	65-8422	Oil return pipe connection ferrule	1
6	A7, A10 and Star Twin	65-8420	Oil return pipe connection	1
7	A7, A10 and Star Twin	65-8424	Oil return pipe nut	1
8	A7, A10 and Star Twin	65-8421	Oil return pipe nut washer (fibre)	1
9	A7, A10 and Star Twin	15-447	Front stand fixing bolt nut	2
10	A7 and A10	67-6530	Front stand complete	1
11	A7, A10 and Star Twin	2-1934	Front stand fork end fixing bolt	2
12	A7, A10 and Star Twin	24-8784	Front stand fork end fixing bolt washer (spring)	2
13	A7, A10 and Star Twin	2-1616	Front stand fork end fixing bolt nut	2
14	A7, A10 and Star Twin	2-2395	Front mudguard support bridge fixing bolt nut	2
15	A7, A10 and Star Twin	2-1462	Front mudguard support bridge fixing bolt washer (spring)	2
16	A7, A10 and Star Twin	2-1462	Front mudguard stay fixing bolt washer (spring)	2
17	A7, A10 and Star Twin	2-2395	Front mudguard stay fixing bolt nut	2
18	A10	67-6546	Front mudguard bridge stay insulator	2
19	A7, A10 and Star Twin	65-6606	Front mudguard support bridge	1
20	A7, A10 and Star Twin	28-2338	Support bridge bottom fixing bolt	4
21	A7, A10 and Star Twin	2-1616	Front mudguard stay fork end fixing bolt nut	2
22	A7, A10 and Star Twin	24-8784	Front mudguard stay fork end fixing bolt washer (spring)	2
23	A7, A10 and Star Twin	15-7354	Front mudguard stay fork end fixing bolt	2
24	A7 and A10	67-6544	Front mudguard stay	1
25	A10	67-6547	Front mudguard stay insulator	2
26	A7 and A10	67-6543	Front mudguard with fixed fittings	1
	A7	65-6605	Front mudguard with fixed fittings (up to 1953)	1
27	A7, A10 and Star Twin	15-7161	Front mudguard fixing bolt	2
28	A7, A10 and Star Twin	27-8560	Front mudguard fixing bolt washer (plain)	2
29	A7, A10 and Star Twin	66-7518	Front mudguard support bridge fixing bolt washer (fibre)	2
30	A7, A10 and Star Twin	27-8560	Front mudguard support bridge fixing bolt washer	2
31	A7, A10 and Star Twin	15-7161	Front mudguard support bridge fixing bolt	2
32	A7, A10 and Star Twin	2-49	Oil tank and air cleaner fixing stud nut	4
33	A7, A10 and Star Twin	24-8784	Oil tank and air cleaner fixing stud washer (spring)	4
34	A7, A10 and Star Twin	29-4100	Oil tank and air cleaner fixing stud (top)	1
35	A7, A10 and Star Twin	36-382	Support bridge bottom fixing bolt washer (shakeproof)	4
36	A7, A10 and Star Twin	2-49	Support bridge bottom fixing bolt nut	4
37	A7, A10 and Star Twin	2-1354	Front stand fixing bolt	2
38	A7, A10 and Star Twin	36-382	Mudguard chainstay bridge bolt washer (shakeproof)	2
39	A7, A10 and Star Twin	67-8313	Mudguard chainstay bridge bolt	2
40	A7, A10 and Star Twin	67-6766	Mudguard front bracket (nearside)	1
41	A7, A10 and Star Twin	2-84	Oil tank drain plug	1
42	A7, A10 and Star Twin	2-100	Oil tank drain plug washer	1
43	A7, A10 and Star Twin	67-4030	Mudguard fixing bolt (seatstay)	2
44	A7, A10 and Star Twin	67-6761	Mudguard fixing bolt (seatstay) spacing washer	2
45	A7, A10 and Star Twin	2-923	Oil tank and air cleaner fixing stud washer	2
46	A7, A10 and Star Twin	29-4101	Oil tank and air cleaner fixing stud (bottom)	1
47	A7, A10 and Star Twin	67-8334	Oil tank with fixed fittings	1
	A7, A10 (Rigid)	67-8320	Oil tank with fixed fittings (up to 1953)	1
48	A7, A10 and Star Twin	24-8784	Oil tank fixing bolt washer (spring)	1
49	A7, A10 and Star Twin	67-8313	Oil tank fixing bolt	1
50	A7, A10 and Star Twin	67-42	Oil tank filler cap washer (fibre)	1
51	A7, A10 and Star Twin	65-8500	Oil tank filler cap	1
52	A7, A10 and Star Twin	24-6770	Mudguard support bracket stay bolt	2
53	A7, A10 and Star Twin	2-923	Mudguard support bracket stay bolt washer	2
54	A7, A10 and Star Twin	67-9054	Saddle	1
	A7, A10 and Star Twin	67-9053	Saddle	1
55	A7, A10 and Star Twin	67-6851	Rear number plate rubber extrusion	1
56	A7, A10 and Star Twin	36-382	Mudguard support bracket stay bolt washer (shakeproof)	2
57	A7, A10 and Star Twin	2-49	Mudguard support bracket stay bolt nut	2
58	A7, A10 and Star Twin	67-6830	Rear number plate complete	1
	A7, A10 and Star Twin	29-6885	Rear number plate complete (up to 1951)	1
	A7, A10 and Star Twin	65-6825	Rear number plate complete (up to 1953)	1
59	A7, A10 and Star Twin	67-6839	Rear mudguard tail lamp wiring grommet	2
60	A7, A10 and Star Twin	67-6841	Rear mudguard with fixed fittings	1
	A7, A10 (Rigid)	67-6752	Rear mudguard with fixed fittings (up to 1953)	1
	A7, A10 & Star Twin (Spring)	67-6771	Rear mudguard with fixed fittings (up to 1953)	1
61	A7, A10 and Star Twin	2-1354	Mudguard support bolt (bottom)	2
62	A7, A10 and Star Twin	67-6772	Mudguard support complete (offside)	1
63	A7, A10 and Star Twin	15-447	Mudguard support bolt nut (bottom)	2

Rear Hub and Wheel Fittings

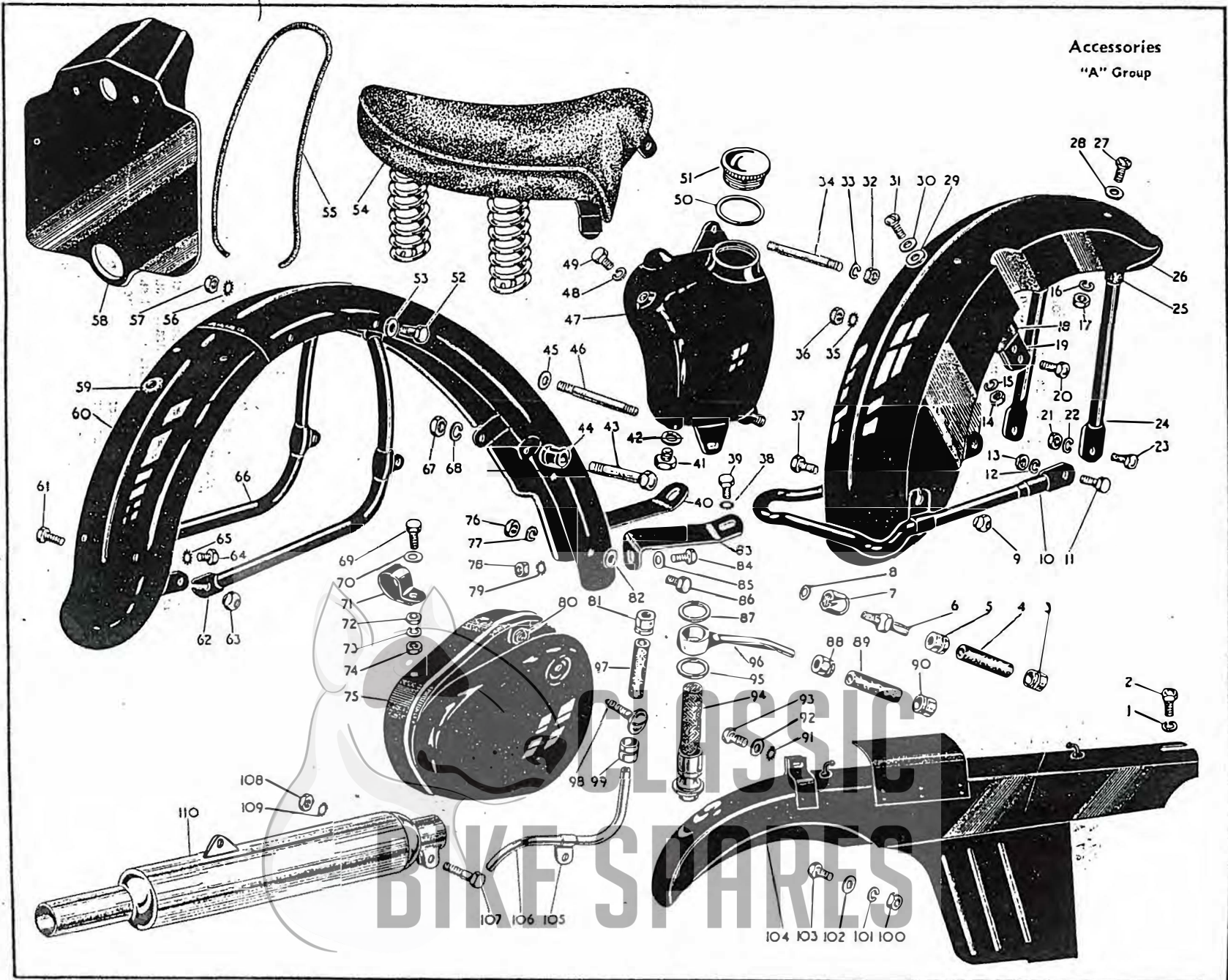

30

Plate 8—continued

ACCESSORIES—"A" GROUP

A7, A10 and Star Twin

Plate Ref. Number.	Model.	Part No.	Description.	Number per set.
64	A7, A10 and Star Twin	2-220	Rear number plate fixing bolt	4
65	A7, A10 and Star Twin	29-541	Rear number plate fixing bolt washer (shakeproof)	4
66	A7, A10 and Star Twin	67-6774	Mudguard support complete (nearside)	1
67	A7, A10 and Star Twin	2-449	Mudguard fixing bolt (seatstay) nut	2
68	A7, A10 and Star Twin	2-522	Mudguard fixing bolt (seatstay) washer (spring)	2
69	A7, A10 and Star Twin	15-4207	Toolbox fixing clip bolt	1
70	A7, A10 and Star Twin	27-8560	Toolbox fixing clip bolt washer	1
71	A7, A10 and Star Twin	24-8927	Toolbox fixing clip	1
72	A7, A10 and Star Twin	2-6537	Toolbox fixing clip distance washer	1
73	A7, A10 and Star Twin	2-1462	Toolbox fixing clip bolt washer (spring)	1
74	A7, A10 and Star Twin	2-2395	Toolbox fixing clip bolt nut	1
75	A7, A10 and Star Twin	67-9002	Toolbox complete	1
	A7 and A10 (Rigid)	65-9080	Toolbox complete (up to 1953)	1
	A7 and Star Twin (Spring)	67-9007	Toolbox complete (up to 1951)	1
76	A7, A10 and Star Twin	2-2395	Toolbox to mudguard fixing bolt nut	2
77	A7, A10 and Star Twin	2-1462	Toolbox to mudguard fixing bolt washer (spring)	2
78	A7, A10 and Star Twin	2-49	Mudguard front bracket fixing bolt nut	2
79	A7, A10 and Star Twin	36-382	Mudguard front bracket fixing bolt washer (shakeproof)	2
80	A7, A10 and Star Twin	2-1027	Toolbox lid fixing screw nut	1
81	A7, A10 and Star Twin	65-8422	Oil breather pipe connection ferrule	1
82	A7, A10 and Star Twin	27-8560	Toolbox to mudguard fixing bolt washer	2
83	A7, A10 and Star Twin	67-6767	Mudguard front bracket (offside)	1
84	A7, A10 and Star Twin	1-5069	Mudguard front bracket fixing bolt	2
85	A7, A10 and Star Twin	2-923	Mudguard front bracket fixing bolt washer	2
86	A7, A10 and Star Twin	2-204	Toolbox to mudguard fixing bolt	2
87	A7, A10 and Star Twin	29-7971	Oil feed banjo washer (fibre)	1
88	A7, A10 and Star Twin	65-8422	Oil feed pipe connection ferrule	1
89	A7, A10 and Star Twin	65-2060	Oil feed pipe connection rubber	1
90	A7, A10 and Star Twin	65-8422	Oil feed pipe connection ferrule	1
91	A7, A10 and Star Twin	36-382	Chainguard rear fixing bolt washers (shakeproof)	1
92	A7, A10 and Star Twin	2-923	Chainguard rear fixing bolt washer (plain)	1
93	A7, A10 and Star Twin	1-5069	Chainguard rear fixing bolt	1
94	A7, A10 and Star Twin	29-7962	Oil tank filter complete	1
95	A7, A10 and Star Twin	29-7971	Oil feed banjo washer (fibre)	1
96	A7, A10 and Star Twin	67-8309	Oil feed pipe complete	1
97	A7, A10 and Star Twin	65-2060	Oil breather pipe connection (rubber)	1
98	A7, A10 and Star Twin	29-9132	Toolbox lid fixing screw complete	1
99	A7, A10 and Star Twin	65-8422	Oil breather pipe connection ferrule	1
100	A7, A10 and Star Twin	2-2395	Chainguard bottom clip bolt nut	1
101	A7, A10 and Star Twin	2-1462	Chainguard bottom clip bolt washer (spring)	1
102	A7, A10 and Star Twin	27-8560	Chainguard bottom clip bolt washer (plain)	1
103	A7, A10 and Star Twin	2-204	Chainguard bottom clip bolt	1
104	A7, A10 and Star Twin	67-7778	Rear chainguard with fixed fittings	1
	A7 and A10 Rigid	67-7725	Rear chainguard with fixed fittings (up to 1950 frame number ZA7-4487)	1
	A7 and A10 Rigid	67-7726	Rear chainguard with fixed fittings (up to 1950 on and after frame number ZA7-4488)	1
	A7, A10 and Star Twin	67-7777	Rear chainguard with fixed fittings (up to 1950 frame number ZA7S-7034)	1
105	A7, A10 and Star Twin	67-8326	Oil tank breather pipe support clip	1
106	A7, A10 and Star Twin	67-8324	Oil tank breather pipe extension	1
107	A7, A10 and Star Twin	24-7343	Silencer inlet tube clip bolt	1
108	A7, A10 and Star Twin	2-2395	Silencer inlet tube clip bolt nut	1
109	A7, A10 and Star Twin	29-541	Silencer inlet tube clip bolt washer (shakeproof)	1
110	A7, A10 and Star Twin	67-2711	Silencer complete	2

Accessori



CLASSIC
BIKE SPARES

Plate 9

ACCESSORIES—"A" GROUP

A7, A10 and Star Twin

Plate Ref. Number.	Model.	Part No.	Description.	Number per set.
1	A7, A10 and Star Twin	67-9087	Dual seat complete	1
2	A7	67-8104/36	Petrol Tank	1
	Star Twin	67-8104/38	Petrol Tank	1
	A7	67-8015/17	Petrol Tank (fitted up to frame number ZA7-4487 (rigid) and ZA7S-7034 (spring frame) (up to 1950)	1
	A7	67-8045/17	Petrol tank (fitted on and after frame number ZA7-4488 (rigid) and ZA7S-7035 (spring frame) (up to 1950)	1
	Star Twin	67-8016/19	Petrol tank (fitted up to frame number ZA7S-7034) (up to 1950)	1
	Star Twin	67-8046/19	Petrol Tank (fitted on and after frame number ZA7S-7035) (up to 1950)	1
	A7	67-8047/17	Petrol Tank (up to 1953)	1
	Star Twin	67-8047/19	Petrol Tank (up to 1953)	1
3	A7, A10 and Star Twin	67-8108	Petrol tank front mounting tube bush (rubber)	2
4	A7, A10 and Star Twin	67-8109	Petrol tank front mounting tube	2
5	A7, A10 and Star Twin	27-5676	Petrol tank front fixing bolt washer	2
6	A7 and Star Twin	65-8326	Petrol tank front fixing bolt	1
7	A7, A10 and Star Twin	29-7898	Petrol tank filler cap	1
8	A7, A10 and Star Twin	29-8810	Front brake control complete (less cable and cover)	1
9	A7, A10 and Star Twin	65-8501	Throttle twist grip	1
10	A7, A10 and Star Twin	66-8896	Air control complete (less cable and cover)	1
11	A7 and Star Twin	67-8521	Throttle cable and cover complete	1
	A10	67-8595	Throttle cable and cover complete	1
12	A7 and Star Twin	67-8555	Air control cable and cover complete	1
	A10	67-8592	Air control cable and cover complete	1
13	Star Twin	65-8714	Ignition control cable and cover complete (for use with manual control magneto)	1
14	Star Twin	66-8810	Ignition control lever complete (for use with manual control magneto)	1
15	A7, A10 and Star Twin	65-8502	Dummy grip (left hand)	1
16	A7, A10 and Star Twin	29-8820	Clutch control complete (less cable and cover)	1
17	A7, A10 and Star Twin	67-8681	Clutch control cable and cover complete	1
18	A7, A10 and Star Twin	65-4960	Handlebar complete (less controls)	1
19	A7 and Star Twin	65-8675	Front brake cable and cover complete	1
	A10	67-8610	Front brake cable and cover complete	1
20	A7, A10 and Star Twin	66-4707	Petrol tank front fixing bolt washer (shakeproof)	1
21	A7, A10 and Star Twin	2-46	Petrol tank front fixing bolt nut	1
22	A7 and A10	65-8317	Petrol tank badge screw	4
23	A7	65-8217	Petrol tank badge screw washer	2
24	A7	65-8209	Petrol tank badge complete (nearside)	1
	A7	65-8207	Petrol tank badge complete (offside)	1
25	A7 and Star Twin	67-4596	Air cleaner and carburettor connection (rubber)	1
26	A7, A10 and Star Twin	67-4588	Air cleaner and carburettor connection spring clip	1
27	A7, A10 and Star Twin	65-2352	Battery carrier swivel block (plain)	1
28	A7, A10 and Star Twin	29-4657	Battery carrier strap	1
29	A7, A10 and Star Twin	29-4662	Battery strap bolt saddle washer	1
30	A7, A10 and Star Twin	29-4661	Battery strap bolt	1
31	A7, A10 and Star Twin	29-4665	Battery locating strip complete	1
32	A7, A10 and Star Twin	29-4664	Battery carrier hinge pin	1
33	A7, A10 and Star Twin	29-3319	Air cleaner element fixing screw washer (shakeproof)	2
34	A7, A10 and Star Twin	2-498	Air cleaner element fixing screw	3
35	A7, A10 and Star Twin	67-8313	Air cleaner fixing screw	1
36	A7, A10 and Star Twin	24-8784	Air cleaner fixing screw washer (spring)	1
37	A7, A10 and Star Twin	67-4600	Air cleaner element	1
38	A7, A10 and Star Twin	67-4594	Air cleaner and battery carrier complete (less element)	1
39	A7, A10 and Star Twin	65-2353	Battery carrier swivel block (tapped)	1
40	A7, A10 and Star Twin	2-46	Petrol tank rear support stud nut	2
41	A7, A10 and Star Twin	66-4707	Petrol tank rear support stud washer (shakeproof)	2
42	A7, A10 and Star Twin	67-8109	Petrol tank rear mounting tube	2
43	A7, A10 and Star Twin	24-8504	Petrol tap washer (fibre)	2
44	A7, A10 and Star Twin	67-8108	Petrol tank rear mounting tube bush (rubber)	2
45	A7, A10 and Star Twin	67-8074	Petrol tank rear support stud	1
46	A7, A10 and Star Twin	67-8092	Petrol tap	2
47	A7, A10 and Star Twin	67-8094	Flexible petrol pipe complete	1
48	A7, A10 and Star Twin	15-541	Dual seat front support bracket fixing stud nut	2
49	A7, A10 and Star Twin	2-1945	Dual seat front support bracket fixing stud washer	2
50	A7, A10 and Star Twin	67-9089	Dual seat front support bracket	1
51	A7, A10 and Star Twin	67-9095	Dual seat front support fixing stud	1
52	A7, A10 and Star Twin	27-6037	Dual seat rear support bracket and mudguard stay fixing bolt	2
53	A7, A10 and Star Twin	2-923	Dual seat rear support bracket and mudguard stay fixing bolt washer	2
54	A7, A10 and Star Twin	67-9094	Dual seat rear support bracket (nearside)	1

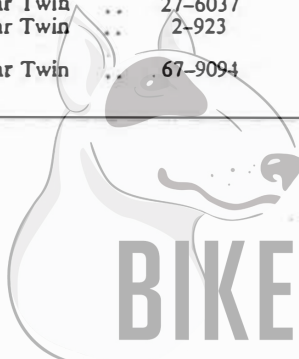

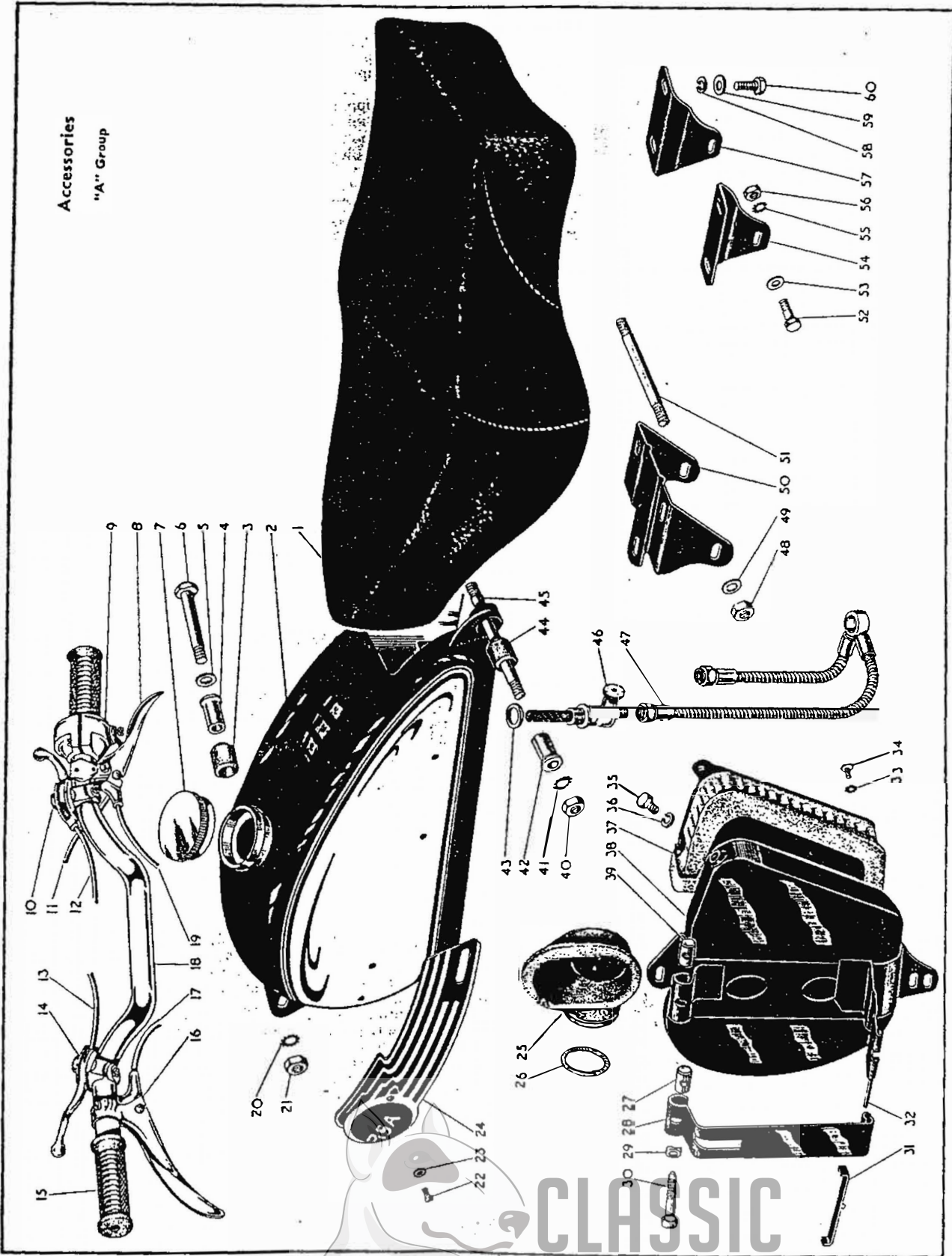

Accessories
"A" Group

CLASSIC
BIKE SPARES

Plate 9—continued

ACCESSORIES—"A" GROUP

A7, A10 and Star Twin.

Plate Ref. Number.	Model.	Part No.	Description.	Number per set.
55	A7, A10 and Star Twin	36-382	Dual seat rear support bracket and mudguard stay fixing bolt washer (shakeproof)	2
56	A7, A10 and Star Twin	2-49	Dual seat rear support bracket and mudguard stay fixing bolt nut	2
57	A7, A10 and Star Twin	67-9093	Dual seat rear support bracket (offside)	1
58	A7, A10 and Star Twin	35-33	Dual seat fixing bolt washer (spring)	7
59	A7, A10 and Star Twin	2-923	Dual seat fixing bolt washer (plain)	7
60	A7, A10 and Star Twin	2-129	Dual seat fixing bolt	7

Plate 10

ACCESSORIES—"A" GROUP

A7, A10 and Star Twin

Plate Ref. Number	Model.	Part No.	Description	Number per set.
1	A10	67-4589	Air cleaner and carburetter connection (rubber)	1
2	A10	67-8111	Petrol tank rear support stud distance collar	2
3	A10	67-8105/26	Petrol tank	1
	A10	67-8105/17	Petrol tank	1
	A10	67-8072/17	Petrol tank (up to 1953)	1
	A10	67-8072/26	Petrol tank (up to 1953)	1
4	A10	27-5690	Petrol tank rear support stud	1
5	A7, A10 and Star Twin	65-8206	Knee grip (left hand)	1
	A7, A10 and Star Twin	65-8205	Knee grip (right hand)	1
6	Star Twin	65-8200	Petrol tank badge rubber ring	2
7	Star Twin	67-8116	Petrol tank badge	2
8	Star Twin	65-8201	Petrol tank badge screw	4
9	A10	67-8071	Petrol tank badge (nearside)	1
	A10	67-8070	Petrol tank badge (offside)	1
10	A10	67-8076	Petrol tank front fixing bolt	1
11	Star Twin	65-6576	Front number plate complete	1
12	Star Twin	2-1462	Front number plate stud washer	1
13	Star Twin	2-2395	Front number plate stud nut	2
14	Star Twin	65-6605	Front mudguard with fixed fittings	1
	Star Twin	67-6543	Front mudguard with fixed fittings (up to 1951)	1
15	Star Twin	65-6607	Front mudguard stay	1
16	Star Twin	65-6606	Front mudguard support bridge	1
17	A7, A10 and Star Twin	2-510	Rear brake rod toggle end screw	1
18	A7, A10 and Star Twin	2-443	Rear brake rod toggle end screw nut	1
19	Star Twin	65-6608	Front stand complete	1
20	A7, A10 and Star Twin	67-7033	Rear brake rod complete	1
21	A7, A10 and Star Twin	2-2395	Rear brake rod abutment nut.	1
22	A7, A10 and Star Twin	15-1312	Rear brake rod spring	1
23	A7, A10 and Star Twin	65-6274	Rear brake rod swivel pin	1
24	A7, A10 and Star Twin	67-7031	Rear brake rod adjusting nut extension tube	1
25	A7, A10 and Star Twin	29-7368	Rear brake rod adjusting nut	1

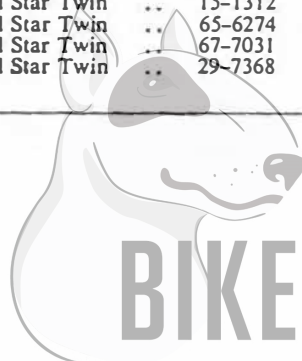

Accessories
"A" Group

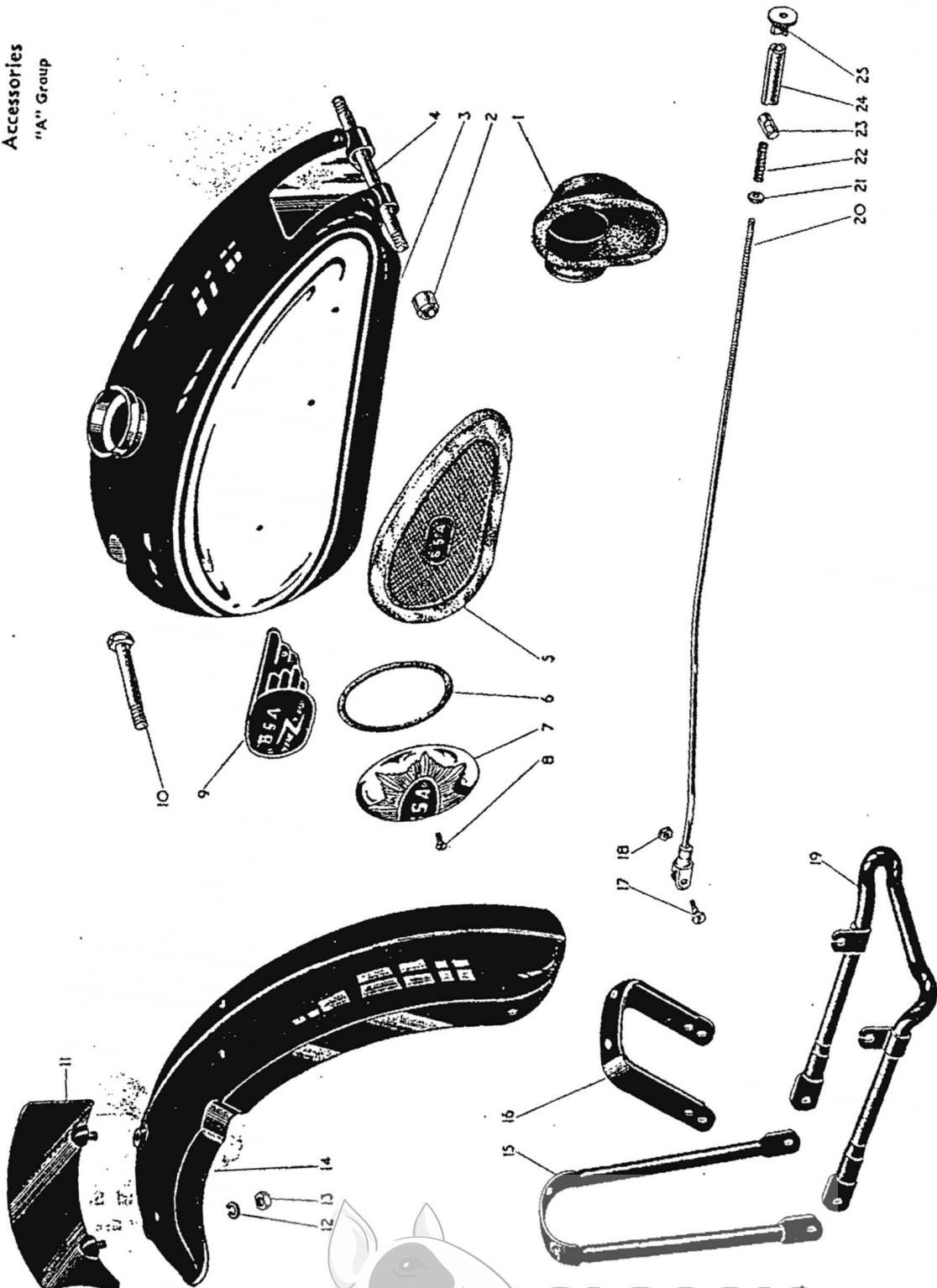

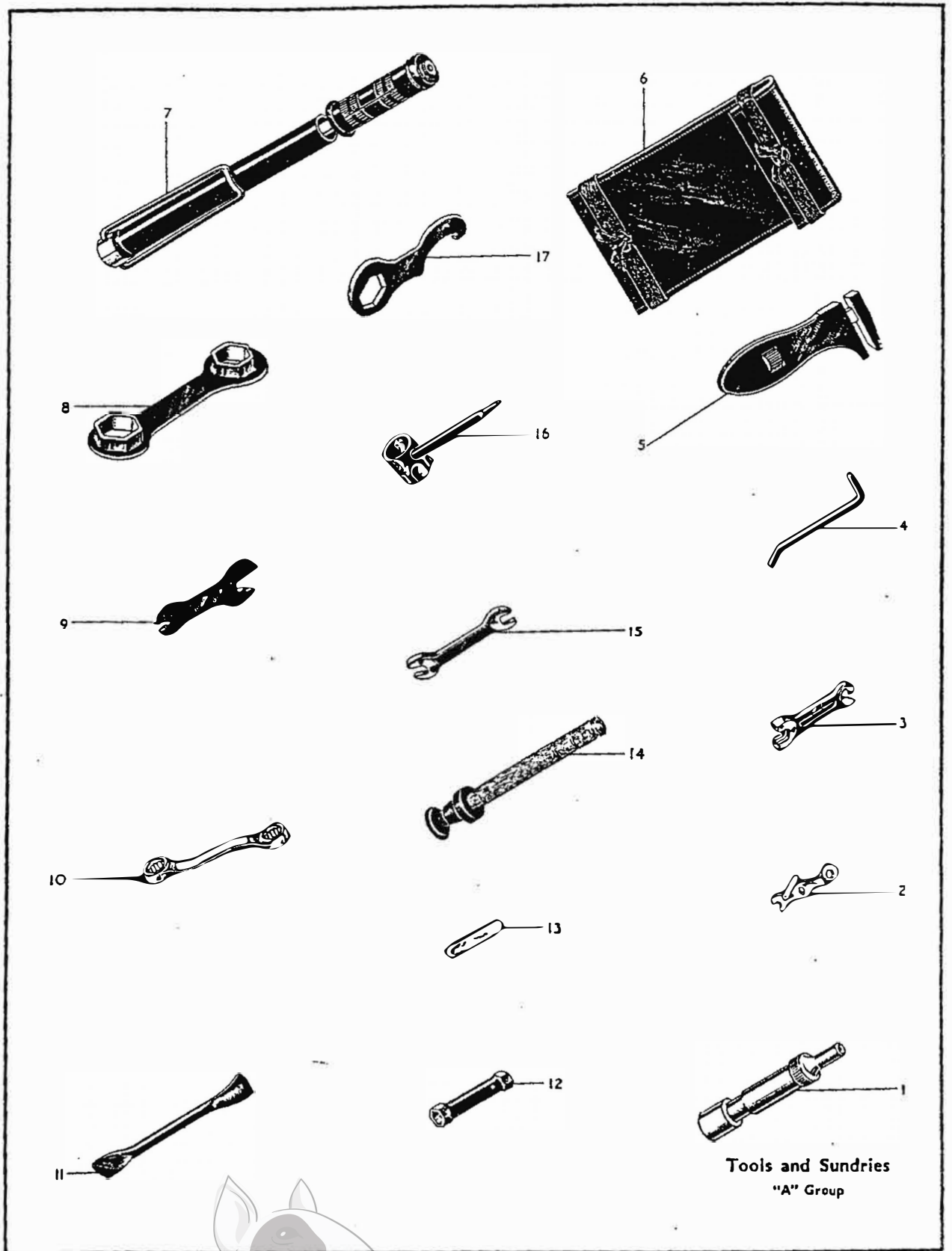

Plate 11

TOOLS AND SUNDRIES
"A" GROUP

Plate Ref. Number.	Model.	Part No.	Description.	Number per set.
1	A7, A10 and Star Twin	28-4265	Grease gun	1
2	A7, A10 and Star Twin	29-9251	Magdyno spanner	1
3	A7, A10 and Star Twin	1-3051	Double ended spanner	1
4	A7, A10 and Star Twin	29-9253	Tommy bar	1
5	A7, A10 and Star Twin	2-824	Adjustable spanner	1
6	A7, A10 and Star Twin	65-9205	Toolbag	1
7	A7, A10 and Star Twin	67-9052	Inflator	1
8	A7, A10 and Star Twin	65-9245	Rear hub spindle nut spanner	1
9	A7, A10 and Star Twin	65-9246	Carburettor and tappet adjusting spanner	1
10	A7, A10 and Star Twin	67-9026	Box spanner	1
11	A7, A10 and Star Twin	29-9252	Tyre lever	1
12	A7, A10 and Star Twin	67-9023	Cylinder head bolt box spanner	1
13	A7, A10 and Star Twin	65-9125	Feeler gauge	1
14	A7, A10 and Star Twin	65-9240	Valve grinding tool	1
15	A7, A10 and Star Twin	67-9025	Double ended spanner	1
16	A7, A10 and Star Twin	66-9132	Sparking plug spanner	1
17	A7, A10 and Star Twin	65-9243	Fork top nut and gland nut spanner	1

CRANKCASE

IF ONE SIDE ONLY IS NEEDED THE OTHER SIDE SHOULD BE SENT TO BE CORRECTLY FITTED. FAILING THIS, A PERFECT FIT CANNOT BE GUARANTEED

B. S. A. GOES ALL OVER THE WORLD

Tools and Sundries



CLASSIC
BIKE SPARES

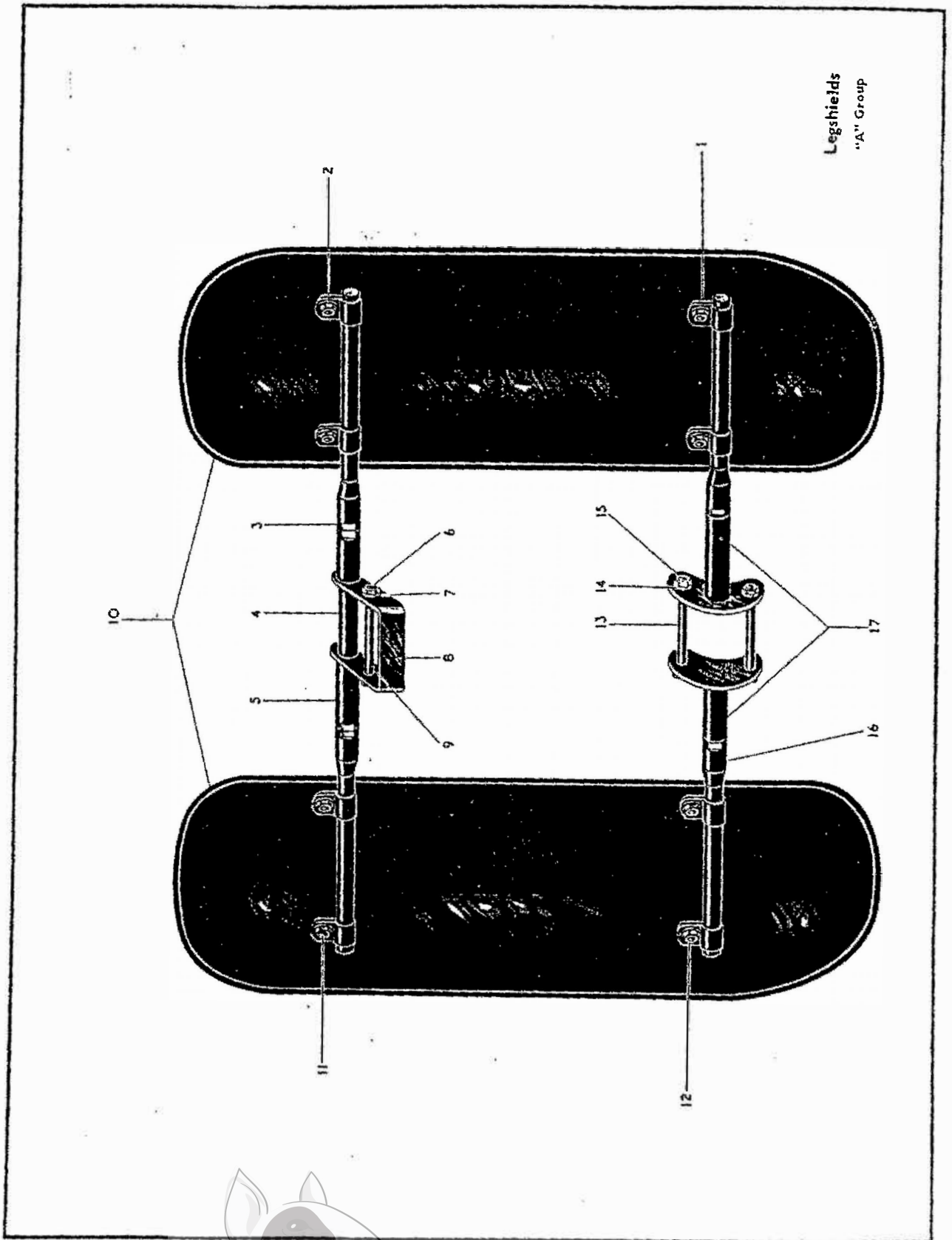

Plate 12

LEGSIELDS
"A" GROUP

Plate Ref. Number	Model.	Part No.	Description.	Number per set
1	A7, A10 and Star Twin	67-7201	Legshields assembled complete	1
2	A7, A10 and Star Twin	66-7353	Legshield support tube clip	8
3	A7, A10 and Star Twin	27-8560	Legshield support tube clip washer	8
4	A7, A10 and Star Twin	67-7205	Legshield top cross tube adaptor	1
5	A7, A10 and Star Twin	67-7204	Legshield top cross tube spacing sleeve	1
6	A7, A10 and Star Twin	67-7205	Legshield top cross tube adaptor	1
7	A7, A10 and Star Twin	2-46	Cross tube adaptor stud nut	2
8	A7, A10 and Star Twin	2-522	Cross tube adaptor stud washer	2
9	A7, A10 and Star Twin	67-7203	Legshield top cross tube clamp	1
10	A7, A10 and Star Twin	27-5683	Legshield top cross tube adaptor stud	2
11	A7, A10 and Star Twin	67-7202	Legshield only	2
12	A7, A10 and Star Twin	15-7161	Legshield support tube clip screw	8
13	A7, A10 and Star Twin	2-2395	Legshield support tube clip nut	8
14	A7, A10 and Star Twin	29-7670	Crankcase and legshield bottom fixing plate stud	2
15	A7, A10 and Star Twin	36-382	Crankcase and legshield bottom fixing plate stud washer	4
16	A7, A10 and Star Twin	2-49	Crankcase and legshield bottom fixing plate stud washer	4
17	A7, A10 and Star Twin	66-7351	Legshield support tube complete	4
17	A7, A10 and Star Twin	67-7208	Bottom cross tube fixing complete	2

BUMPER BAR
"A" GROUP

Part No.	Description	Number per set
67-4920	Front bumper bar assembled complete	1
67-4923	Front bumper bar bracket (top)	2
67-4924	Front bumper bar bracket (bottom)	2
67-4925	Front bumper bar bush	1
24-5658	Front bumper bar bolt	1
2-1925	Front bumper bar nut	1
3-110	Front bumper bar washer (spring)	1
27-6275	Frame, crankcase and exhaust pipe lug stud (replaces 67-1251 when bumper bars are fitted)	1

Legshields
Bumper
Bar



CLASSIC
BIKE SPARES

ELECTRICAL EQUIPMENT
"A" GROUP

Plate Ref. Number	Model	Part No.	Description.	Number per set.
1	A7, A10 and Star Twin	19-1000	Stop lamp	1
	A7, A10 and Star Twin	19-1001/7	Tail lamp (up to 1953)	1
2	A7, A10 and Star Twin	2-14	Voltage control bolt	2
3	A7, A10 and Star Twin	2-1374	Voltage control bolt washer (plain)	2
4	A7, A10 and Star Twin	24-8784	Voltage control bolt washer (shakeproof)	2
5	A7, A10 and Star Twin	2-2395	Voltage control bolt nut	2
6	A7, A10 and Star Twin	27-8560	Voltage control bolt washer (bottom)	2
7	A7, A10 and Star Twin	15-7383	Voltage control support rubber	2
8	A7, A10 and Star Twin	27-8560	Voltage control bolt washer (top)	4
9	A7, A10 and Star Twin	2-2395	Voltage control bolt nut (top)	2
10	A7, A10 and Star Twin	2-443	Voltage control bolt locknut	2
11	A7 and A10	19-1210	Magneto	1
	Star Twin	19-1203	Magneto	1
12	A7, A10 and Star Twin	19-1515	Voltage control	1
13	A7, A10 and Star Twin	19-1472	Cut-out	1
14	A7, A10 and Star Twin	19-2012	Horn push	1
15	A7	19-511/37	Headlamp (cowl fitting)	1
	Star Twin	19-512/39	Headlamp (cowl fitting)	1
	A10	19-513/24	Headlamp (cowl fitting)	1
	A7, A10 and Star Twin	19-514	Headlamp (up to 1953)	1
16	A7, A10 and Star Twin	19-1207	Dynamo	1
17	A7	19-2112	Speedometer (solo and sidecar) (120 m.p.h.)	1
	A7	19-2123	Speedometer (solo and sidecar) (180 k.p.h.)	1
	Star Twin	19-2109	Speedometer (solo) (120 m.p.h.)	1
	Star Twin	19-2121	Speedometer (solo) (180 k.p.h.)	1
	A10 and Star Twin	19-2112	Speedometer (sidecar) (120 m.p.h.)	1
	A10 and Star Twin	19-2123	Speedometer (sidecar) (180 k.p.h.)	1
	A10	19-2111	Speedometer (solo) (120 m.p.h.)	1
	A10	19-2122	Speedometer (solo) (180 k.p.h.)	1
	A7	19-2106	Speedometer (solo) (120 m.p.h.) (up to 1953)	1
	A7	19-2120	Speedometer (solo) (180 k.p.h.) (up to 1953)	1
	A7, A10 and Star Twin	19-2106	Speedometer (sidecar) (120 m.p.h.) (up to 1953)	1
	A7, A10 and Star Twin	19-2120	Speedometer (sidecar) (180 k.p.h.) (up to 1953)	1
	Star Twin	19-2110	Speedometer (solo) (120 m.p.h.) (up to 1953)	1
	Star Twin	19-2119	Speedometer (solo) (180 k.p.h.) (up to 1953)	1
	A10	19-2107	Speedometer (solo) (120 m.p.h.) (up to 1953)	1
	A10	19-2114	Speedometer (solo) (180 k.p.h.) (up to 1953)	1
18	A7, A10 and Star Twin	67-5088	Speedometer and headlamp cowl rubber ring	1
19	A7, A10 and Star Twin	19-2126	Speedometer cable rubber grommet	1
20	A7, A10 and Star Twin	19-469	Ammeter	1
21	A7, A10 and Star Twin	67-9068	Electric horn	1
	A7, A10 and Star Twin	19-2004	Electric horn (up to 1953)	1
22	A7, A10 and Star Twin	2-49	Stop light switch plate clip bolt nut	1
23	A7, A10 and Star Twin	36-382	Stop light switch plate clip bolt washer	1
24	A7, A10 and Star Twin	2-923	Stop light switch plate clip bolt washer (plain)	1
25	A7, A10 and Star Twin	24-8927	Stop light switch plate clip	1
26	A7, A10 and Star Twin	2-47	Stop light switch screw nut	1
27	A7, A10 and Star Twin	29-3319	Stop light switch screw washer	2
28	A7, A10 and Star Twin	2-1309	Stop light switch screw	2
29	A7, A10 and Star Twin	29-9342	Stop light switch plate	1
30	A7, A10 and Star Twin	2-1588	Stop light spring clip nut	1
31	A7, A10 and Star Twin	29-3319	Stop light spring clip screw washer	1
32	A7, A10 and Star Twin	65-9228	Stop light spring clip	1
33	A7, A10 and Star Twin	65-5912	Stop light spring clip screw	1
34	A7, A10 and Star Twin	65-9231	Stop light operating spring	1
35	A7, A10 and Star Twin	19-1106	Stop light switch	1
36	A7, A10 and Star Twin	28-2338	Stop light switch plate and clip bolt	1
37	A7, A10 and Star Twin	65-5087	Headlamp rubber extrusion	1
38	A7, A10 and Star Twin	67-5084	Headlamp cowl	1
39	A7, A10 and Star Twin	67-9063	Speedometer cable	1
	A7, A10 and Star Twin	67-9057	Speedometer cable (4-speed) (used up to 1953)	1
40	A7, A10 and Star Twin	19-657	Cable harness with switch and dipper switch	1

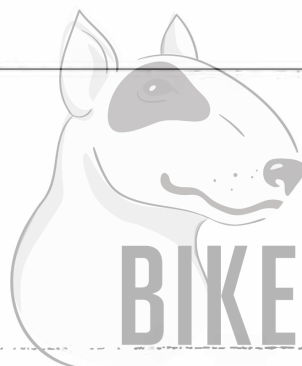

ELECTRICAL EQUIPMENT—"A" GROUP

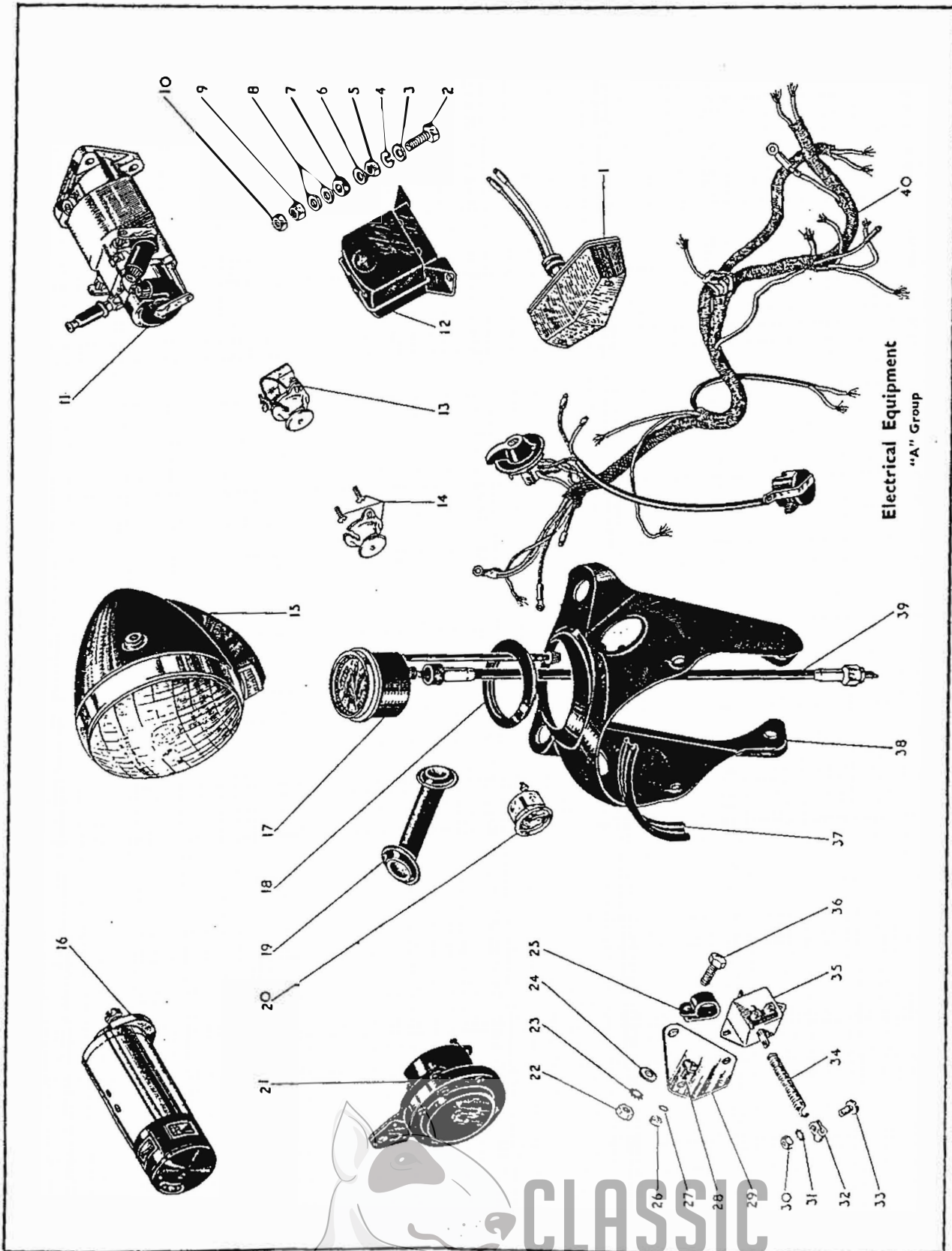

Electrical Equipment
"A" Group

Electrical
Equipment

SIDECAR CHASSIS

No. 22 and No. 23.

DESCRIPTION.	No. 22	No. 23
FRONT STAY.		
Front stay complete	3-1720	3-1720
Front stay cone nut	3-345	3-345
Front stay cone nut washer (spring)	3-108	3-108
Front stay cone collar	3-1792	3-1792
Front connecting lug	3-1373	3-1748
Front connecting lug bolt	3-1372	3-1372
Front connecting lug bolt split pin	35-713	35-713
Front connecting lug bolt nut	3-953	3-953
Front connecting lug stud nut	—	2-46(2)
Front connecting lug bolt packing washer (plain)	24-5914	24-5914
Front connecting lug stud washer (plain)	—	2-833(2)
Front connecting lug clip bolt	3-1271	3-1271
Front connecting lug clip bolt washer (spring)	3-110	3-111
FRONT SUPPORT TUBE.		
Front support tube complete with bolts and nuts	3-1719	3-1719
Front support tube	3-1716	3-1716
Front bottom connection	3-1259	3-1259
Front bottom connection bolt	3-1271	3-1271
Front bottom connection bolt nut	2-1925	2-1925
Front support tube bolt (motor cycle end)	3-619	3-619
Front bottom tube bolt nut (motor cycle end)	2-46	2-46
SADDLE PILLAR.		
Saddle pillar adjusting tube complete	3-1724	3-1724
Saddle pillar tube complete	3-1725	3-1725
Saddle pillar telescopic tube complete	3-1603	3-1603
Saddle pillar telescopic tube lug	3-1258	3-1258
Saddle pillar tube lug bolt	3-1271	3-1271
Saddle pillar tube lug bolt nut	2-1925	2-1925
Saddle pillar telescopic tube bottom lug	3-1252	3-1252
Saddle pillar telescopic tube bottom lug bolt	3-1289	3-1289
Saddle pillar telescopic tube bottom lug bolt nut	2-1925	2-1925
Saddle pillar telescopic tube bottom washer (spherical)	3-1290(2)	3-1290(2)
Saddle pillar telescopic tube bottom lug bolt washer (spring)	15-716	15-716
Saddle pillar tube lug bolt	3-1393	3-1393
Saddle pillar connecting bolt nut	3-1137	3-1137
Saddle pillar connecting bolt washer (spring)	3-107	3-107
Saddle pillar connecting bolt washer	30-729(2)	30-729(2)
Saddle pillar tube lug bolt	3-619	3-619
Saddle pillar tube lug bolt nut	2-46	2-46
Saddle pillar tube lug bolt washer (spring)	3-111	3-111
INSIDE STRUT.		
Inside strut complete	3-9263	3-9263
Tube end spindle washer (plain)	24-5914	24-5914
Tube end spindle nut	3-953	3-953
Tube end spindle split pin	35-713	35-713
MAIN FRAME.		
Axle tube complete	3-1709	3-1709
Main rear connection	3-1700	3-1700
Main rear connection washer (spherical)	3-663	3-663
Main rear washer (double spring)	3-664	3-664
Main rear connection nut	2-1946	2-1946
Main rear connection grease nipple	28-2080	28-2080
Main rear connection split pin	35-722	35-722
Wheel bracket	3-1701	3-1701

Figures in brackets denote number per set.



42
**CLASSIC
BIKE SPARES**

SIDECAR CHASSIS—continued

No. 22 and No. 23.

DESCRIPTION.	No. 22	No. 23
OUTSIDE TIE.		
Outside tie complete	3-9264	3-9264
Tube end spindle washer (plain)	24-5914	24-5914
Tube end spindle nut	3-953	3-953
Tube end spindle split pin	35-713	35-713
FRONT SPRING (TWIN).		
Front spring	3-861(2)	3-861(2)
Front spring cup	3-839(2)	3-839(2)
Front spring bracket	3-603(2)	3-1021(2)
Front spring bracket bolt	30-1215(4)	30-1215(4)
Front spring bracket bolt washer (spring)	35-33(4)	35-33(4)
Front spring clamp plate	3-641(2)	3-641(2)
Front spring connecting bolt nut	2-46(2)	2-46(2)
Front spring bearer bar	3-1369	3-1750
Front spring connecting bolt washer (spring)	3-111(2)	3-111(2)
Front spring (inner)	—	3-1080
Front spring connecting bolt	2-803(2)	2-803(2)
REAR SPRING.		
Rear spring complete with bush	3-1746(2)	3-1746(2)
Rear spring bush	3-1706(2)	3-1706(2)
Rear spring shackle complete with bush	3-1704(2)	3-1704(2)
Rear spring shackle bush	3-1706(2)	3-1706(2)
Rear spring shackle bolt	3-1383(2)	3-1383(2)
Rear spring shackle bolt nut	15-5753(2)	15-5753(2)
Rear spring shackle bolt washer (spring)	3-107(2)	3-107(2)
Rear spring shackle grease nipple	28-2080	28-2080
Rear bearer bar	3-1703	3-1703
Rear bearer bar nut	3-1509(2)	3-1509(2)
Rear bearer bar split pin	35-708(2)	35-708(2)
Rear bearer bar washer (plain)	2-1945(2)	2-1945(2)
Rear bearer bar thrust washer	24-875(2)	24-875(2)
Rear bearer bar connecting bolt (for No. 47 sidecar body only)	65-4185(2)	65-4185(2)
Rear bearer bar connecting bolt nut	2-46(2)	2-46(2)
Rear bearer bar connecting bolt washer (spring)	3-111(2)	3-111(2)
Rear bearer bar connecting bolt clamp washer (plain)	30-650(2)	30-650(2)
Rear bearer bar connecting bolt (for No. 48 commercial box body)	3-1712(2)	3-1712(2)
Rear spring plate	3-1714(4)	3-1714(4)
Rear spring plate clamp stud	3-1715(8)	3-1715(8)
Rear spring plate clamp stud nut	2-49(8)	2-49(8)
Rear spring plate clamp stud washer (spring)	35-33(8)	35-33(8)
SIDECAR STAND.		
Sidecar stand	3-1379	3-1379
Sidecar stand bolt	2-803	2-803
Sidecar stand bolt nut	2-1813	2-1813
Sidecar stand bolt washer (spring)	2-995	2-995

Figures in brackets denote number per set.



CLASSIC BIKE SPARES

SIDECAR CHASSIS—*continued*

No. 22 and No. 23.

DESCRIPTION.	No. 22	No. 23
WHEEL AND HUB.		
Wheel complete (less tyre, spindle and bearings)	3-9380	3-9380
Wheel rim (WM 3-19)	3-9381	3-9381
Wheel spoke	27-7010(40)	27-7010(40)
Wheel spoke nipples	27-6810(40)	27-6810(40)
Hub shell complete with cups	3-9077	3-9077
Hub shell grease nipple	28-2080	28-2080
Hub ball bearings	$\frac{1}{2}$ " (31)	$\frac{1}{2}$ " (31)
Hub spindle	3-1702	3-1702
Wheel spindle castle nut	3-1116	3-1116
Wheel spindle split pin	35-705	35-705
Hub cup (large)	3-36	3-36
Hub cup (small)	3-37	3-37
Hub spindle cone (fixed)	3-1241	3-1241
Hub spindle cone (adjusting)	3-34	3-34
Hub spindle cone washer (plain)	3-103	3-103
Hub spindle cone castle nut	3-62	3-62
Hub spindle cone castle nut split pin	35-705	35-705
Hub spindle bracket washer	27-8039	27-8039
Hub shell cap	3-1685	3-1685
MUDGUARD.		
Mudguard	3-1730	3-1730
Mudguard stays complete	3-1731	3-1731
Mudguard stay support tube complete	3-1741	3-1741
Support tube lug bolt	3-12(2)	3-12(2)
Support tube lug bolt nut	2-49(2)	2-49(2)
Support tube lug bolt washer (spring)	35-33(2)	35-33(2)
Mudguard upright stay screw	1-5945(2)	1-5945(2)
Mudguard upright stay nut	2-2395(2)	2-2395(2)
Mudguard upright stay screw washer (plain)	27-8560(2)	27-8560(2)
Mudguard upright stay screw washer (spring)	2-1462(2)	2-1462(2)
Mudguard upright stay bolt	28-2338	28-2338
Mudguard upright stay bolt nut	2-49	2-49
Mudguard upright stay bolt washer (plain)	2-2899	2-2899
Mudguard upright stay bolt washer (spring)	24-8784	24-8784
Mudguard rear stay bolt	28-2338	28-2338
Mudguard rear stay bolt nut	2-49	2-49
Mudguard rear stay bolt washer (plain)	2-2899	2-2899
Mudguard rear stay bolt washer (spring)	24-8784	24-8784
Mudguard stay fixing packing washer	3-101(2)	3-101(2)
Front and rear stay bolt	1-5945(4)	1-5945(4)
Front and rear stay bolt nut	2-2395(4)	2-2395(4)
Front and rear stay bolt washer (plain)	27-8560(4)	27-8560(4)
Front and rear stay bolt washer (spring)	2-1462(4)	2-1462(4)
Mudguard support tube bolt	31-7275	31-7275
Mudguard support tube bolt nut	27-6974	27-6974
Mudguard support bolt distance nut	24-5860	24-5860
Mudguard support lug and spindle nut complete	3-1795	3-1795
SUNDRIES.		
Sidecar lamp (Lucas ref.)	19-1109	19-1109
Sidecar lamp packing washer	31-4070	31-4070

Figures in brackets denote number per set.



CLASSIC BIKE SPARES

STANDARD BOLTS. All Bolts are C.E.I. unless otherwise stated.

Part No.	Length under Head.	Thickness of Head.	Length of Thread.	Across Flats	Diameter.
2-14	1 1/32"	3/16"	13/16"	.440" Hex.	1/4"
2-204	1/2"	3/16"	1/2"	.440" Hex.	1/4"
2-220	3/8"	3/16"	3/8"	.440" Hex.	1/4"
2-1354	.641"	.187"	.641"	.440" Hex.	1/4"
2-1402	7/8"	1/8"	3/8"	.440" Hex.	1/4"
2-2273	7/16"	5/32"	3/8"	.440" Hex.	1/4"
24-225	.750"	.187"	3/8"	.440" Hex.	1/4"
1-5069	.625"	.187"	.625"	.525" Hex.	5/16"
2-129	.750"	.250"	.625"	.440" Hex.	5/16"
2-1934	.750"	.156"	.625"	.440" Hex.	5/16"
2-6026	1.187"	.156"	.625"	.440" Hex.	5/16"
15-480	1.109"	.250"	.781"	.525" Hex.	5/16"
15-1355	1.500"	.218"	.625"	.525" Hex.	5/16"
15-7354	.625"	.156"	.625"	.440" Hex.	5/16"
27-6311	.750"	.125"	.625"	.440" Hex.	5/16"
28-2338	.718"	.218"	.687"	.525" Hex.	5/16"
24-649	.877"	.187"	.877"	.594" Hex.	3/8"
65-4185	2.687"	.250"	.750"	.504" Hex.	3/8"

All Bolts are C.E.I. (Screwdriver slotted) unless otherwise stated.

Part No.	Length under Head.	Thickness of Head.	Length of Thread.	Across Head.	Diameter.
1-4606	.500"	.125"	.500"	.312"	3/16"
2-360	.406"	.078"	.406"	.312"	3/16"
2-498	.312"	.062"	.312"	.312"	3/16" Whit.
2-1309	.343"	.062"	.343"	.312"	3/16"
2-2582	.343"	.125"	.343"	.250"	3/16" Whit.
24-7065	.250"	.062"	.250"	.312"	3/16"
2-77	.312"	.062"	.312"	.375"	1/4"
2-79	.500"	.109"	.500"	.375"	1/4"
2-510	.656"	.093"	.375"	.375"	1/4"
2-1500	.687"	.109"	.375"	.375"	1/4"
2-2210	.718"	.062"	.562"	.562"	1/4"
2-2378	.656"	.109"	.656"	.375"	1/4"
15-7161	.500"	.125"	.312"	.500"	1/4"
2-2980	1.25"	.93"	.625"	.562"	5/16"

STANDARD NUTS. All Nuts are C.E.I. unless otherwise stated.

Part No.	Across Flats.	Thickness.	Size.	Part No.	Across Flats.	Thickness.	Size.
1-4616	.340" Hex.	.162"	3/16"	2-1813	.594" Hex.	.218"	3/8"
2-47	.312" Hex.	.140"	3/16"	3-720	.594" Hex.	.187"	3/8"
2-1588	.255" Hex.	.110"	3/16"	24-5161	.594" Hex.	.343"	3/8"
15-8147	.340" Hex.	.125"	3/16"	24-5764	.782" Hex.	.312"	3/8"
25-7151	.340" Hex.	.187"	3/16"	2-440	.594" Hex.	.312"	7/16"
1-6032	.340" Hex.	3/16"	1/4"	2-933	.525" Hex.	.375"	7/16"
2-51	.440" Hex.	.250"	1/4"	2-1925	.782" Hex.	.375"	7/16"
2-53	.440" Hex.	.109"	1/4" Whit.	15-152	.592" Hex.	.406"	7/16"
2-443	.440" Hex.	.109"	1/4"	15-541	.782" Hex.	.281"	7/16"
2-1027	.340" Hex.	1/8"	1/4"	24-5860	.594" Hex.	.187"	7/16"
2-2395	.440" Hex.	.187"	1/4"	25-4325	.919" Hex.	.540"	7/16"
2-49	.525" Hex.	.218"	5/16"	2-52	.919" Hex.	.406"	1/2"
2-833	.440" Hex.	.343"	5/16"	2-124	.782" Hex.	.203"	1/2"
2-1616	.440" Hex.	.125"	5/16"	24-7000	.782" Hex.	.250"	1/2"
15-5196	.525" Hex.	.281"	5/16"	27-6716	.782" Hex.	.187"	1/2"
15-6524	.525" Hex.	.175"	5/16"	2-835	.919" Hex.	.375"	9/16"
24-563	.440" Hex.	.187"	5/16"	15-1455	.782" Hex.	.218"	9/16"
24-6040	.525" Hex.	.156"	5/16"	24-4255	.919" Hex.	.187"	9/16"
1-1706	.594" Hex.	.250"	3/8"	28-53	.782" Hex.	.344"	9/16"
2-46	.594" Hex.	.312"	3/8"				

STANDARD WASHERS (PLAIN)

Part No.	Outside Dia.	Inside Dia.	Thickness	Part No.	Outside Dia.	Inside Dia.	Thickness
1-1804	.680"	.385"	.072"	2-2580	.500"	.275"	.064"
2-130	.687"	.380"	.080"	3-3525	.562"	.218"	.048"
2-370	.625"	.317"	.156"	15-39	.843"	.505"	.064"
2-525	.500"	.255"	.048"	15-431	.750"	.442"	.064"
2-861	.750"	.380"	.081"	15-5155	.525"	.328"	.048"
2-923	.625"	.317"	.062"	24-594	.937"	.505"	.092"
2-1096	.375"	.192"	.044"	24-7911	.875"	.380"	.156"
2-1291	.750"	.522"	.080"	25-7180	1.00"	.281"	.048"
2-1374	.656"	.255"	.080"	26-9461	.562"	.203"	.048"
2-1945	.875"	.442"	.064"	27-5676	1.00"	.380"	.092"
2-2138	.380"	.750"	.064"	27-8560	.625"	.255"	.048"

STANDARD WASHERS (SPRING)

Part No.	Outer Dia.	Inside Dia.	Thickness	Part No.	Outer Dia.	Inside Dia.	Thickness
2-522	.750"	.390"	.056"	15-716	.937"	.453"	.064"
2-995	.656"	.380"	.040" double	24-978	.437"	.255"	.040"
2-1462	.593"	.255"	.040"	24-6035	.593"	.317"	.040" double
2-1967	.875"	.440"	.064"	27-6043	.750"	.437"	.046" double
2-2903	.562"	.406"	.062"	24-8784	.625"	.315"	.040"
3-110	.441"	.281"	.080"	35-33	.500"	.343"	.080"
3-111	.614"	.406"	.104"				

STANDARD WASHERS (SHAKEPROOF)

Part No.	Outer Dia.	Inside Dia.	Part No.	Outer Dia.	Inside Dia.
29-541	$\frac{1}{8}$ "	$\frac{1}{16}$ "	36-399	$\frac{1}{8}$ "	$\frac{1}{16}$ "
29-3319	$\frac{1}{8}$ "	$\frac{1}{16}$ "	65-595	$\frac{1}{8}$ "	$\frac{1}{16}$ "
36-341	$\frac{1}{8}$ "	$\frac{1}{16}$ "	66-4707	$\frac{1}{8}$ "	$\frac{1}{16}$ "
36-382	$\frac{1}{8}$ "	$\frac{1}{16}$ "	66-4708	$\frac{1}{8}$ "	$\frac{1}{16}$ "

SPLIT PINS

Part No.	Dia.	Length	Part No.	Dia.	Length
35-698	$\frac{1}{8}$ "	1"	35-709	$\frac{1}{8}$ "	1 $\frac{1}{2}$ "
35-701	$\frac{1}{8}$ "	$\frac{1}{2}$ "	35-710	$\frac{1}{8}$ "	$\frac{3}{4}$ "
35-705	$\frac{1}{8}$ "	$\frac{3}{4}$ "	35-700	$\frac{1}{8}$ "	$\frac{3}{4}$ "
35-706	$\frac{1}{8}$ "	$\frac{1}{2}$ "	2-856	$\frac{1}{8}$ "	$\frac{1}{8}$ "
35-707	$\frac{1}{8}$ "	1"			

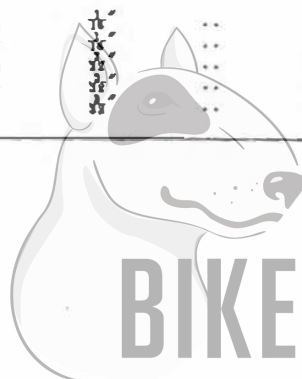

TRANSMISSION CHAINS—"A" GROUP

Model	Part No.	Description	Number per Set	Price
A7 (Rigid)	67-1703	Front (Duplex) .375" x .250" dia. roller x 80 pitches	1	P.O.A.
"	67-9041	Rear (Solo) $\frac{1}{2}$ " x $\frac{3}{8}$ " x .400" roller x 102 pitches	1	P.O.A.
"	67-9042	Rear (sidecar) $\frac{1}{2}$ " x $\frac{3}{8}$ " x .400" roller x 103 pitches	1	P.O.A.
"	29-2199	Dynamo 8 mm. x 5 mm. dia. roller x 3 mm. wide x 48 pitches	1	P.O.A.
A7 (Spring) & Star Twin	67-1703	Front (Duplex) .375" x .250" dia. roller, x 80 pitches	1	P.O.A.
"	67-9041	Rear (Solo) $\frac{1}{2}$ " x $\frac{3}{8}$ " x .400" roller x 102 pitches	1	P.O.A.
"	67-9045	Rear (sidecar) $\frac{1}{2}$ " x $\frac{3}{8}$ " x .400" roller x 104 pitches	1	P.O.A.
"	29-2199	Dynamo 8 mm. x 5 mm. dia. roller x 3 mm. wide x 48 pitches	1	P.O.A.
A10 (Rigid)	67-1703	Front (Duplex) .375" x .250" dia. roller x 80 pitches	1	P.O.A.
"	67-9046	Rear (solo) $\frac{1}{2}$ " x $\frac{3}{8}$ " x .400" roller x 100 pitches	1	P.O.A.
"	67-9042	Rear (sidecar) $\frac{1}{2}$ " x $\frac{3}{8}$ " x .400" roller, x 103 pitches	1	P.O.A.
"	29-2199	Dynamo 8 mm. x 5 mm. dia. roller x 3 mm. wide x 48 pitches	1	P.O.A.
A10 (Spring)	67-1703	Front (Duplex) .375" x .250" dia. roller x 80 pitches	1	P.O.A.
"	67-9046	Rear (solo) $\frac{1}{2}$ " x $\frac{3}{8}$ " x .400" roller x 100 pitches	1	P.O.A.
"	67-9045	Rear (sidecar) $\frac{1}{2}$ " x $\frac{3}{8}$ " x .400" roller x 104 pitches	1	P.O.A.
"	29-2199	Dynamo 8 mm. x 5 mm. dia. roller x 3 mm. wide x 48 pitches	1	P.O.A.

TO MAINTAIN THE ORIGINAL RELIABILITY AND PERFORMANCE OF YOUR B.S.A. MOTOR CYCLE FIT ONLY SPARES

MADE BY B.S.A.



ENGINE AND FRAME MARKINGS—1949 to 1953

Year	Model	Type	Engine	Frame
1949	A7	500 cc. O.H.V. (Rigid)	ZA7-101 upwards	ZA7-101 upwards
1949	A7	500 cc. O.H.V. (Spring)	ZA7-101 upwards	ZA7S-101 upwards
1949	Star Twin	500 cc. O.H.V.	ZA7S-101 upwards	ZA7S-101 upwards
1950	A7	500 cc. O.H.V. (Rigid)	ZA7-7001 upwards	ZA7-4001 upwards
1950	A7	500 cc. O.H.V. (Spring)	ZA7-7001 upwards	ZA7S-6001 upwards
1950	Star Twin	500 cc. O.H.V.	ZA7S-4001 upwards	ZA7S-6001 upwards
1950	A10	650 cc. O.H.V. (Rigid)	ZA10-101 upwards	ZA7-4001 upwards
1950	A10	650 cc. O.H.V. (Spring)	ZA10-101 upwards	ZA7S-6001 upwards
1951	A7	500 cc. O.H.V. (Rigid)	AA7-101 upwards	ZA7-6001 upwards
1951	A7	500 cc. O.H.V. (Spring)	AA7-101 upwards	ZA7S-14001 upwards
1951	Star Twin	500 cc. O.H.V.	AA7S-101 upwards	ZA7S-14001 upwards
1951	A10	650 cc. O.H.V. (Rigid)	ZA10-4001 upwards	ZA7-6001 upwards
1951	A10	650 cc. O.H.V. (Spring)	ZA10-4001 upwards	ZA7S-14001 upwards
1952	A7	500 cc. O.H.V. (Rigid)	AA7-5001 upwards	ZA7-8001 upwards
1952	A7	500 cc. O.H.V. (Spring)	AA7-5001 upwards	ZA7S-26001 upwards
1952	Star Twin	500 cc. O.H.V.	AA7S-1001 upwards	ZA7S-26001 upwards
1952	A10	650 cc. O.H.V. (Rigid)	ZA10-12001 upwards	ZA7-8001 upwards
1952	A10	650 cc. O.H.V. (Spring)	ZA10-12001 upwards	ZA7S-26001 upwards
1953	A7	500 cc. O.H.V. (Rigid)	BA7-101 upwards	BA7-101 upwards
1953	A7	500 cc. O.H.V. (Spring)	BA7-101 upwards	BA7S-101 upwards
1953	Star Twin	500 cc. O.H.V.	BA7S-101 upwards	BA7S-101 upwards
1953	A10	650 cc. O.H.V. (Rigid)	BA10-101 upwards	BA7-101 upwards
1953	A10	650 cc. O.H.V. (Spring)	BA10-101 upwards	BA7S-101 upwards

WHEN REPLACEMENTS BECOME NECESSARY FOR YOUR
B.S.A. MOTOR CYCLE ALWAYS FIT GENUINE B.S.A. SPARES

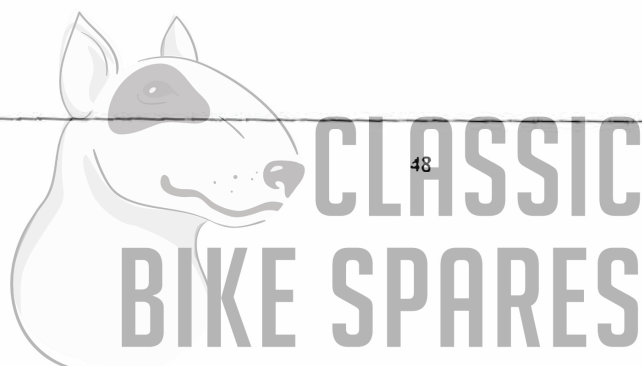

48
**CLASSIC
BIKE SPARES**

PISTON CHART 1949 to 1953—"A" GROUP

MODEL	Compression ratio	PISTONS COMPLETE			COMPRESSION RINGS			SCRAPER RINGS			YEAR
		Standard	½ mm. O.S.	1 mm. O.S.	Standard	½ mm. O.S.	1 mm. O.S.	Standard	½ mm. O.S.	1 mm. O.S.	
A7	.. 6.6 to 1	.. 67-195	.. 67-197	.. 67-199	.. 67-87	.. 67-88	.. 67-89	.. 67-90	.. 67-91	.. 67-92	.. 1949
A7	.. 7 to 1	.. 67-81	.. 67-83	.. 67-85	.. 67-87	.. 67-88	.. 67-89	.. 67-90	.. 67-91	.. 67-92	.. 1949
A7	.. 7.5 to 1	.. 67-103	.. 67-105	.. 67-107	.. 67-87	.. 67-88	.. 67-89	.. 67-90	.. 67-91	.. 67-92	.. 1949
A7	.. 8.6 to 1	.. 67-93	.. 67-95	.. 67-97	.. 67-87	.. 67-88	.. 67-89	.. 67-90	.. 67-91	.. 67-92	.. 1949
A7	.. 6.6 to 1	.. 67-195	.. 67-197	.. 67-199	.. 67-87	.. 67-88	.. 67-89	.. 67-90	.. 67-91	.. 67-92	.. 1950
A7	.. 7 to 1	.. 67-81	.. 67-83	.. 67-85	.. 67-87	.. 67-88	.. 67-89	.. 67-90	.. 67-91	.. 67-92	.. 1950
A7	.. 7.5 to 1	.. 67-103	.. 67-105	.. 67-107	.. 67-87	.. 67-88	.. 67-89	.. 67-90	.. 67-91	.. 67-92	.. 1950
A7	.. 8.6 to 1	.. 67-93	.. 67-95	.. 67-97	.. 67-87	.. 67-88	.. 67-89	.. 67-90	.. 67-91	.. 67-92	.. 1950
A10	.. 6.5 to 1	.. 67-304	.. 67-306	.. 67-308	.. 67-311	.. 67-312	.. 67-313	.. 67-314	.. 67-315	.. 67-316	.. 1950
A10	.. 7.25 to 1	.. 67-365	.. 67-367	.. 67-369	.. 67-311	.. 67-312	.. 67-313	.. 67-314	.. 67-315	.. 67-316	.. 1950
A7	.. 6.7 to 1	.. 67-460	.. 67-462	.. 67-464	.. 67-407	.. 67-408	.. 67-409	.. 67-410	.. 67-411	.. 67-412	.. 1951-52
A7	.. 7.25 to 1	.. 67-466	.. 67-468	.. 67-470	.. 67-407	.. 67-408	.. 67-409	.. 67-410	.. 67-411	.. 67-412	.. 1951-52
A7 Star Twin	7.25 to 1	.. 67-533	.. 67-535	.. 67-537	.. 67-407	.. 67-408	.. 67-409	.. 67-410	.. 67-411	.. 67-412	.. 1951-52
A10	.. 6.7 to 1	.. 67-423	.. 67-425	.. 67-427	.. 67-311	.. 67-312	.. 67-313	.. 67-314	.. 67-315	.. 67-316	.. 1951-52
A10	.. 7.25 to 1	.. 67-429	.. 67-431	.. 67-433	.. 67-311	.. 67-312	.. 67-313	.. 67-314	.. 67-315	.. 67-316	.. 1951-52
A10	.. 9 to 1	.. 67-545	.. 67-547	.. 67-549	.. 67-311	.. 67-312	.. 67-313	.. 67-314	.. 67-315	.. 67-316	.. 1951-52
A10	.. 14 to 1	.. 67-551	.. 67-553	.. 67-555	.. 67-311	.. 67-312	.. 67-313	.. 67-314	.. 67-315	.. 67-316	.. 1951-52
A7	.. 6.7 to 1	.. 67-460	.. 67-462	.. 67-464	.. 67-407	.. 67-408	.. 67-409	.. 67-410	.. 67-411	.. 67-412	.. 1953
A7	.. 7.25 to 1	.. 67-466	.. 67-468	.. 67-470	.. 67-407	.. 67-408	.. 67-409	.. 67-410	.. 67-411	.. 67-412	.. 1953
A7	.. 8 to 1	.. 67-566	.. 67-568	.. 67-570	.. 67-407	.. 67-408	.. 67-409	.. 67-410	.. 67-411	.. 67-412	.. 1953
A7 Star Twin	7.25 to 1	.. 67-533	.. 67-535	.. 67-537	.. 67-407	.. 67-408	.. 67-409	.. 67-410	.. 67-411	.. 67-412	.. 1953
A10	.. 6.5 to 1	.. 67-423	.. 67-425	.. 67-427	.. 67-311	.. 67-312	.. 67-313	.. 67-314	.. 67-315	.. 67-316	.. 1953
A10	.. 7.25 to 1	.. 67-429	.. 67-431	.. 67-433	.. 67-311	.. 67-312	.. 67-313	.. 67-314	.. 67-315	.. 67-316	.. 1953
A10	.. 9.1 to 1	.. 67-545	.. 67-547	.. 67-549	.. 67-311	.. 67-312	.. 67-313	.. 67-314	.. 67-315	.. 67-316	.. 1953

EVERY OWNER OF A B.S.A. MOTOR CYCLE IS STRONGLY
ADVISED TO BUY ONLY—GENUINE B.S.A. SPARE PARTS

