

# **BSA** **SPARES**

20-10141C

**M MODELS**

**SINGLE CYLINDER**

**500 c.c. and 600 c.c.**

**1949-1958**



**CLASSIC  
BIKE SPARES**

# 1949 to 1958

## MODELS

M 20	.	500 S.V.	.	1949—1956
M 21	.	600 S.V.	.	1949—1958
M 33	.	500 O.H.V.	.	1949—1957



CATALOGUE OF



ISSUED BY

B.S.A. Motor Cycles Ltd.

Service Department

Montgomery Street

Birmingham II

Telephone: ... .. BIRMINGHAM, VICTORIA 2234 (6 lines)

Telegrams: ... .. "SELSERV, BIRMINGHAM"

All Communications relating to Spare Parts or Repairs to B.S.A. Motor Cycles should be addressed to the above

B.S.A. MOTOR CYCLES LTD.

Registered Offices and Works: ARMOURY ROAD, BIRMINGHAM II

Telephones: BIRMINGHAM, VICTORIA 2381 (30 lines)

Telegrams and Cables: "SELMOTO BIRMINGHAM"

Contractors to Her Majesty's Government, the War Office, the Admiralty, the Post Office, the Colonial and Foreign Governments





## GENERAL INDEX

	<i>Page</i>
Carburettor Settings ... ..	76
Clutch and Front Chaincase ... ..	25-28
Colour Finishes ... ..	3
Electrical Equipment ... ..	73-74
Engine (General) ... ..	12-22
Engine and Frame Markings ... ..	87
Frame and Fittings ... ..	28-36
Front Hub and Wheel Fittings ... ..	43-46
Front Fork and Fittings ... ..	38-41
Gearbox ... ..	22-25
Legshields (Standard) ... ..	69
Legshields (Automobile Association) ... ..	69
Mudguards, Oil Tank, Toolbox, Chainguards ... ..	49-54
Petrol Tank, Handlebar, Dual Seat, Battery Carrier, Silencers ... ..	56-59
Pistons ... ..	87
Rear Hub and Wheel Fittings ... ..	46-49
Rear Mudguard, Toolbox, Chainguard, Rear Brake Control, Silencer ... ..	57-62
Safety Bars (Front and Rear) ... ..	76
Sidecar Chassis (Standard) ... ..	78-80
Sidecar Chassis (Automobile Association) ... ..	80-85
Spares, Repairs, Guarantee ... ..	4-6
Special Components (Automobile Association) ... ..	66
Stockists ... ..	7-11
Tools and Sundries ... ..	71





SUFFIX NUMBERS TO BE USED TO IDENTIFY VARYING FINISHES  
FOR "M" GROUP MOTOR CYCLES

- /3 Bright Chrome                    /36 Maroon and Chrome (Petrol Tanks)
- /7 Black Enamel                    /44 Black and Chrome (Wheels)
- /48 Maroon and Cream (Petrol Tanks)

When ordering components with varying finishes—i.e., Petrol tanks, wheels, rims, brake rods, front fork oil seal holder—please state finish required by adding the appropriate suffix number to the part number.

EXAMPLE. Petrol Tank.

Maroon and Chrome Lined Gold 66-8285/36.

SPARKING PLUGS.

Champion Sparking Plugs Ltd., Feltham, Middlesex.

ELECTRICAL EQUIPMENT.

J. Lucas Ltd., Great King Street, Birmingham.

SPEEDOMETERS.

Smith's Motor Accessories, Cricklewood Works, London.



COPY OF  
B.S.A. MOTOR CYCLE SPARE PARTS GUARANTEE

We give the following guarantee with B.S.A. Motor Cycle Spare Parts, instead of the guarantee implied by statute or otherwise, as to the quality or fitness of such parts for the purpose for which they are intended, any such implied guarantee being in all cases excluded, nor can any claim for consequential damages be entertained.

WE GUARANTEE, subject to the conditions mentioned below, that all precautions which are usual and reasonable have been taken by us to secure excellence of materials and workmanship, but this guarantee is to extend and be in force for six months only from the date of purchase, and the damages for which we make ourselves responsible under this guarantee are limited to the replacement of any part which may have proved defective.

WE UNDERTAKE, subject to the conditions mentioned below, to make good at any time within six months any defects in these respects. As motor cycles are easily liable to derangement by neglect or misuse, this guarantee does not apply to defects caused by wear and tear, misuse, or neglect.

REPAIRS AND RENOVATIONS GUARANTEE

Any B.S.A. motor cycle sent to us to be re-enamelled, or repaired will be treated upon the same conditions as if it were a new motor cycle, i.e., we guarantee that all precautions which are usual and reasonable have been taken by us to secure excellence of material and workmanship, such guarantee to extend and be in force for six months only from the time such work shall have been executed, and this guarantee is in lieu and in exclusion of any Common Law or statute warranty, and the damages recoverable are limited to the cost of any further work which may be necessary to amend and make good the work found to be defective.

CONDITIONS OF GUARANTEE

If a defective part should be found in our motor cycles it must be sent to our Service Department, carriage paid, and be accompanied by an intimation from the sender that he desires it repaired free of charge under our guarantee, and he must also furnish us at the same time with the number of the frame and engine, which will be found stamped on the seat or head tube lug and on the crankcase, the name of the Dealer from whom he purchased, and the date of the purchase.

Failing compliance with the above no notice will be taken of anything which may arrive but such articles will lie here at the risk of the sender, and this guarantee or any implied guarantee shall not be enforceable.

We do not guarantee the specialities of other firms, such as tyres, electrical equipment, saddles, etc., or of any component part supplied to the order of the purchaser differing from our standard specifications, whether supplied with our motor cycles or otherwise.

THE TERM "AGENT"

We do not appoint agents for the sale of our motor cycles or other goods. We assign to motor cycle Dealers (styled "Regional" Dealers), who carry on business on their own account, areas in which they have the exclusive or other right to sell goods purchased from us. A Regional Dealer purchasing from us, or a Sub-Dealer purchasing from him, may, on our behalf (as our agent for the purpose only) give the guarantee printed above. Any such Dealer is not authorised to advertise, incur any debts, or transact any business whatsoever on our account, nor is he authorised, so as to bind us to give any warranty or make any representation on our behalf or to sell subject to or with any conditions other than those contained in such guarantee.



## B.S.A. SERVICE

When you purchase a B.S.A. machine you become the owner of a product which is backed by the most comprehensive motor cycle service in the world. The following notes are intended to give a guide to the facilities available to the B.S.A. owner. Detailed information on any aspect of B.S.A. Service may be obtained by discussion with your B.S.A. Dealer or on application to the factory Service Department.

### REPLACEMENT PARTS.

The moderate price at which B.S.A. replacement parts are available, has been maintained by making full use of trade distribution channels, with the consequent advantages of large consignments delivered from the works with lower handling, packing and transport costs. For this reason, we do not normally supply spares direct to individual owners, and all requests for replacement parts should be made to your local Dealer or spare parts Stockist.

All B.S.A. Dealers carry stocks of B.S.A. replacement parts, but the officially appointed spare parts Stockists, whose names and addresses are quoted in the following pages, maintain an extensive and comprehensive range.

B.S.A. owners are strongly advised to fit genuine B.S.A. replacement parts only. Risks are incurred in not always insisting on the genuine component, and these risks are eliminated if parts are purchased only from our recognised Dealers.

### REPAIRS.

(1). All motor cycles, engines, sidecars or components for repair should be consigned to the factory Service Department at the following address:—

B.S.A. Motor Cycles Limited,  
Service Department,  
Montgomery Street,  
Birmingham 11.

Full instructions must accompany all items sent to us for repair. If we are simply asked to overhaul a machine, all component parts will be completely dismantled and inspected, all worn parts will be renewed and the machine re-assembled and tested to original inspection standards.

(2). When sending complete motor cycles, accessories such as windscreens, panniers, Club badges, tools and inflators should be removed as they are liable to be damaged or lost in transit.

(3). It frequently happens that parts are forwarded to us which do not bear the senders name and address. Care in this respect will prevent delay and annoyance.

(4). All goods consigned to us must be sent carriage paid.

(5). Immediately we receive a part for repair, an acknowledgment and confirmation of your instructions is posted to you. If you have occasion to enquire by letter or telephone about the progress of the repairs, please follow the instructions printed on your form of acknowledgment.

### B.S.A. EXCHANGE REPLACEMENT SERVICE.

The B.S.A. Exchange Replacement Service is of great value to all B.S.A. owners. It is particularly useful to those who rely on their machines for daily transport, and who cannot afford to have them off the road for more than a few hours at a time. Under this scheme the owner can exchange any worn or otherwise unserviceable unit, such as engine, gearbox, forks or wheels, for a fully-guaranteed factory-assembled replacement unit. These units are ready for immediate use, and are supplied at the fixed prices quoted at the back of this catalogue on the understanding that the old units which they replace are not damaged to a degree where they are not capable of being reconditioned.

All genuine B.S.A. Exchange Replacement units carry the full six months warranty. Most B.S.A. Dealers and officially appointed spare parts Stockists are able to supply genuine exchange units from stock. If this cannot be done, they can obtain the unit for you quickly from the works, and make arrangements for it to be fitted to your machine, afterwards returning the old unit to us. In this way the machine need only be off the road long enough for the conversion to be made. Full details of this scheme can be obtained from your B.S.A. Dealer, and an explanatory leaflet and price list will be sent upon request to B.S.A. Service Department.

Gearbox

Clutch  
Front  
ChainFrame  
FittingFront F  
and  
FittingFront  
and W  
FittingRear H  
and W  
FittingMudguard  
Oil Tank  
Toolbox  
ChainPetrol  
Handle  
Dual  
Battery C  
and SideRear Mud  
Toolbox  
Chain  
Rear Br  
Control  
and SideSpecial  
Component  
Supply  
Automotive  
Associa

Magazine

Tools  
SundriesElectrical  
EquipmentFront  
Saver  
Saver  
and LSidecar  
Chassis

CLASSIC  
BIKE SPARES



## CORRESPONDENCE.

We maintain a skilled staff to help you with any query, technical or otherwise which you may have concerning your B.S.A. machine. We are always anxious to help, and all correspondence should be addressed to us at:—

B.S.A. Motor Cycles Limited,  
Service Department,  
Montgomery Street,  
Birmingham 11.

## HOURS OF BUSINESS.

Our Service Department is open from 8.30 a.m. to 5.30 p.m. Monday to Friday, excepting holiday periods, and we are pleased to see B.S.A. owners, and if necessary, to inspect and advise on the condition of their machines.

We cannot guarantee, however, to be able to service any machine if a call is made without an appointment, and even when calling by appointment, an owner should be prepared to leave his machine with us, in case the work cannot be completed on the same day.

A commissionaire is always on duty to receive machines brought to the Service Department by appointment, at any time of the day or night, on any day of the week, and similar arrangements are made for collection. Any machine delivered to us after hours should, however, be accompanied by full instructions in writing, together with the owner's name and address.

## SERVICE LITERATURE.

An Instruction Book is supplied free of charge with each machine and contains all the information required for routine maintenance, and top overhaul. For the normal owner this book will cover all the work that he is likely to undertake. Further copies of Instruction Books to cover all post-war and most pre-war models are available from the Service Department.

For the guidance of Dealers and other skilled mechanics, the Service Department also issues Service Manuals to cover each model. These manuals contain detailed instructions for complete dismantling and overhaul, and describe the special tools and jigs which are necessary for this purpose. The B.S.A. owner who has considerable mechanical experience, and feels that he is competent to carry out this more skilled type of work may obtain a copy of the Service Manual for his machine from the Service Department.

Additional Instruction Books are priced 2/- plus 3d. postage, and Service Manuals are 6/- plus 6d. postage, for each model. Full details of the machine should always be quoted.



## LIST OF B.S.A. STOCKISTS.

Save time and postage by contacting your nearest B.S.A. Stockist for B.S.A. Spare Parts, Spare Part Catalogues, Instruction Books, Transfers, etc. All B.S.A. Dealers carry stocks of B.S.A. Spare Parts but the following appointed Stockists maintain a comprehensive range.

Town.	Name of Stockist.	Address.	Telephone No.	Telegraphic Address.
Aberdeen	J. Dawson	24-26, Thistle Street	25556	
"	George Cheyne (Cycles) Ltd.	147-149, Holburn Street	26027	Motobike, Aberdeen.
Aberystwyth	Gwalia Motor Co.	North Parade	525	
Accrington	Bill Snape Ltd.	379, Blackburn Road	4724	
Aldershot	Phillips Bros. (Aldershot) Ltd.	Birchett Road	1111/2	Phillips, Cycles, Aldershot.
Alloa	J. G. Robertson	55-57, High Street	193	
Andover	Corbett & Ellis (Andover) Ltd.	Weyhill Road	2991	
Ashington	Mains of Ashington	Laburnham Terrace	3204	
Aylesbury	Eborn's Garage	44, Walton Street, Aylesbury	150	Eborn's, Aylesbury.
Banbury	Trinder Bros.	2 and 3, Broad Street	2545	
Barnsley	T. Garner & Son	Sheffield Road	2866	
Barnstaple	Bob Ray Ltd.	43, High Street	4266	
Bath	R. U. Holloway & Son	32-33-34, St. John's Road, Bathwick	5084	
Bedford	The Imperial Cycle Co.	58, St. Lyses	2374	
Belfast	W. J. Chambers & Co.	106 and 108, Donegall Pass	27253/4	Fastmote, Belfast.
Biggleswade	Bryants	25, 27, 72 and 74, Shortmead Street	3108	
Birkenhead	Bob Simister Ltd.	540, New Chester Road, Rock Ferry	Rock Ferry 1452	
Birmingham	County Cycle & Motor Co. Ltd.	266, Broad Street 104, Bath Row (Repairs) (closed Saturday 1 p.m.)	Midland 2671 Midland 2817	
"	C. E. Cope & Sons Ltd.	481-487, Hagley Road, Edgbaston	17 .. Bearwood 2246/7	
"	Shovelbottom's Ltd.	376, Ladypool Road, Sparkbrook	12 .. South 2212	
"	Aston Auto Motors	172, Aston Road, 6	Aston Cross 3201/2	
Blackburn	Shuttleworth & Geldart	15-17, Great Bolton Street	6678	
Blackpool	J. Hall & Son	102/6, Devonshire Road (opp. School)	22130	
Blandford	Badger Garages Ltd.	Salisbury Road	615	
Bolton	Charlie Robinson	119 and 121, Higher Bridge Street	3931	
Boscombe	Craze Bros.	473 and 475, Christchurch Road	Boscombe 35231/2	
Bradford	C. Sidney Ltd.	107, Manningham Lane	29889	
"	J. K. Hirst	41, Wakefield Road	22543	
Bridgwater	Anderson & Wall	18, St. Mary Street	2416	Anderson & Wall, Bridgwater.
Brighton	Redhill Motors (Brighton) Ltd.	104, North Road	5281	
Bristol	S. J. Fair Motors Ltd.	201/3, Cheltenham Road	46238	
Bromsgrove	Harold Tozer (Bromsgrove) Ltd.	110, Birmingham Road	3228	
Brynmawr	Jayne's Motors	Cwmbach Garage	Brynmawr 271	
Bury-St-Edmunds	Barclay Motors	Kings Road Corner	2345.9	
Cambridge	King & Harper Ltd.	Milton Road Corner	55201	Motors, Cambridge
Canterbury	Marcel Hallet	St. Dunstan's Street	2275/6	
Cardiff	Car Distributors (Cardiff) Ltd.	134-140, City Road	30022	
"	Robert Bevan & Son	2955, Castle Street	1808	

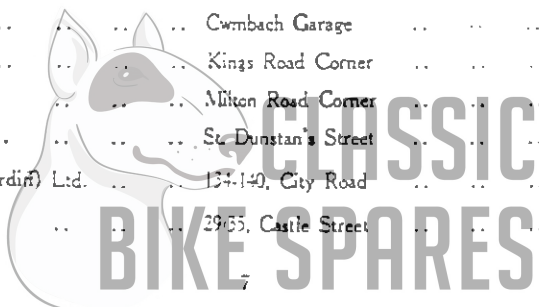

Engin  
Gearbox  
Clutch & Front Chaincase  
Frame Fitting  
Front Fork and Fittings  
Front End and Wheel Fitting  
Rear Hub and Wheel Fittings  
Mudguard Oil Tank Toolbox & Chaincase  
Petrol Tank Handlebars Dual Seat Battery Car and Silencer  
Rear Mudguard Toolbox Chainguard Rear Brake Control and Silencer  
Special Components supplied Automobile Association  
Legshield  
Tools and Sundries  
Electric Equipment  
Front and Safety Bells and Lamps  
Sidecar Chassis  
Carriage

Town.	Name of Stockist.	Address.	Telephone No.	Telegraphic Address
Carlisle .. ..	W. T. Tiffin & Son .. ..	Irishgate Brow .. ..	25024	Tiffin, Irishgate, Carlisle.
Carmarthen .. ..	Eddie Stephens (Motors) .. ..	22/23, Water Street .. ..	C'ihen 233	
Castleford .. ..	Barrett's Motor Cycles (Castleford) Ltd..	27/35,, Aire Street .. ..	2983	
Chapel-en-le-Frith	E. W. Bowers .. ..	129, Town End .. ..	144	
Chatham .. ..	Grays of Chatham Ltd. .. ..	11-19, High Street .. ..	4005	
Chelmsford .. ..	Hadlers Garage Ltd. .. ..	New Street .. ..	4844/5	Hadler, Chelmsford.
Cheltenham .. ..	Leslie Paynter .. ..	Bath Street .. ..	2887	
Chester .. ..	Davies Bros. .. ..	34, Bridge Street .. ..	510	
Chichester .. ..	W. Goodridge & Co. Ltd. .. ..	East Street .. ..	2033	
Clydebank .. ..	Weddell & Devine .. ..	72/114, Dumbarton Road	1429	
Colchester .. ..	G.B.R. Motors Ltd. .. ..	1-2, East Hill .. ..	6131/2	
Colne .. ..	C. H. Scholfield (Motors) Ltd. .. ..	Market Place .. ..	859	
Coventry .. ..	Coventry Motor Mart Ltd. .. ..	86, London Road .. ..	2146/7	Coventry Motor Mart.
Crewe .. ..	Cooke's Garages (Crewe Ltd.) .. ..	10-20, Nantwich Road .. ..	2011	Cooke's Motors, Crewe.
Croydon .. ..	Godfreys Ltd. .. ..	228/234, London Road .. ..	Croydon 3641/2	Gofrabike, Croydon.
Dagenham .. ..	Reginald Smith .. ..	Imperial House, New Road .. ..	Rainham 3284/2796	
Dalton-in-Furness	H. Holme .. ..	24/26, Ulverston Road .. ..	25	
Darlington .. ..	The Duplex Motor and Cycle Co. Ltd..	10-16, Grange Road .. ..	Darlington 2071	Duplex, Darlington.
" .. ..	White Bros. .. ..	205/9, Northgate .. ..	67757	
Dartford .. ..	Schweizo Bros. .. ..	177, Lowfield Street .. ..	4279	
Derby .. ..	Ingle's Provincial Garages Ltd. .. ..	Walbrook Road .. ..	45289	
Doncaster .. ..	W. Cusworth (Doncaster) Ltd. .. ..	7, Hall Gate .. ..	4594	
Douglas (I.O.M.)	Gilbert Harding .. ..	18, Duke Street .. ..	Douglas 170	
Dudley .. ..	Chas. E. Cope & Sons Ltd. .. ..	193, High Street .. ..	Dudley 3464/5/6	
Dundee .. ..	George McLean Ltd. .. ..	Ward Road, Riverside Drive .. ..	5087	Vehicles, Dundee.
Dunstable .. ..	B. G. England (Dunstable) Ltd. .. ..	Halfmoon Hill, London Road .. ..	843/4	
Eastbourne .. ..	Jempsons Ltd. .. ..	118, Seaside .. ..	756	Jempsons, Eastbourne.
Edinburgh .. ..	J. R. Alexander & Co. Ltd. .. ..	10/14, Lothian Road .. ..	4455	Motorcycles, Edinburgh.
Elgin .. ..	Farquharsons .. ..	55/57, High Street .. ..	7188	Elgin 7188
Enfield .. ..	D. J. Shepherd & Co. (Enfield) Ltd.	434/6, Hertford Road, Enfield Highway..	Howard 1631	
Exeter .. ..	P. Pike & Co. Ltd. .. ..	Alphington Street .. ..	58241	Piko, Exeter.
Frome .. ..	J. Difazio .. ..	25, Catherine Street .. ..	2913	
Gateshead, 8 .. ..	O. Carmichael & Son .. ..	75, 83 and 87 High Street West	71815	
Glasgow, C3 .. ..	Bell Bros. (H.P.) Ltd. .. ..	215/233, St. George Road .. ..	Douglas 6414	Douglas 6414 Glasgow.
" C4 .. ..	J. R. Alexander & Co. Ltd. .. ..	264-280, Great Western Road .. ..	Douglas 3802/3/4	Alex Moto, Glasgow.
Gloucester .. ..	Harpers Garage .. ..	23a, Worcester Street .. ..	23187	Gloucester 23187
Grimsby.. ..	H. J. Cresswells and Sons Ltd. .. ..	13/15, Osborne Street .. ..	2202	
Guernsey .. ..	Millard & Co. Ltd. .. ..	Victoria Road .. ..	777	Millard Motors. Guernsey
Guildford .. ..	E. Pascall (Guildford) Ltd. .. ..	11/12, Woodbridge Road .. ..	Guildford 2274 5, 6	
Harrogate .. ..	H. Aclam (Prop. H. Baynes) .. ..	11, Bower Road .. ..	5125	
Harrow .. ..	E. T. Pink (Harrow) Ltd. .. ..	Station Road .. ..	Speres 3328 0044/5	Pink, Harrow.
Hatfield .. ..	W. Waters & Sons Ltd. .. ..	52, Great North Road .. ..	3255	



CLASSIC  
BIKE SPARES



Town.	Name of Stockist	Address.	Telephone No.	Telegraphic Address	Eng
Hereford	A. Kear & Co.	52b, Commercial Street	2239	Kear, Hereford.	
Holbeach,	G. Woodman Ltd.	34, Fleet Street	3221		
Hornchurch	T. W. Kirby	10, Roneo Corner	8785		Gearb
Hounslow	Stanley's Motors	46/8, Lampton Road	Hounslow 1949		
Huddersfield	Earnshaw	Manchester Road	1232		
Hull	Browns (Witham) Ltd.	47/49, Witham	33990/9		Clutch Fro Chain
"	Jordan & Co. (Hull) Ltd.	Storey Street	36909	Gumption, Hull	
Ilford	J. J. Double	14, Mildmay Parade, Cranbrook Road	Valentine 3109		Frax Fit
Ilkston	Ray Gamble	Station Road	873		
Ipswich	Revetts Ltd.	Clarkson Street	2822		
Jersey	Colebrooks (J. D. Poingdestre)	1, New Street	Central 642	Colebrooks, Jersey	Front an Fitti
Keighley	Dick Ratcliffe	Coldshaw Garage, Haworth	Haworth 3133		
Kendal	Tom O'Loughlin	66, Stricklandgate	315		
Kirkcaldy	County Motors (Kirkcaldy) Ltd.	Junction Road	Dysart 5631		Front and W Fitti
Lancaster	Pye Motors Ltd.	Parliament Street	828		
Launceston	J. Wooldridge & Son	Western Road	21	Wooldridge, Launceston.	
Leeds, 1	Watson-Cairns & Co. Ltd.	157/8, Lower Briggate	23379	Watson-Cairns, Briggate, Leeds.	Rear F and W Fitti
Leicester	E. W. Campion & Son Ltd.	Welford Place	58054		
Lerwick	Thompson's Motors	Esplanade, Lerwick	85	Thompson's Garage Lerwick	Mudgu Oil Toolbo Chaing
Lincoln	West's (Lincoln) Ltd.	116, High Street	10762-3-4		
Liverpool, 7	Bee Cycle & Motor Co. Ltd.	17-19, Renshaw Street	Royal 6375/6	Bee Cycles, Liverpool.	
" 3	Cundles (Liverpool) Ltd.	41 and 61, Byron Street	Central 4148	Cundles, Central 4148.	
Llwhaden	James Bowen & Sons	Llwhaden, near Narberth, Pem.	Llwhaden 6		Petrol Handl Dual Battery C and S
London, W.1	Godfreys Ltd.	208/10, Great Portland Street	Euston 4632/4	Gofrabike, London	ear Mud Toolbo Chaingu Rear Br Contr and Sil
" N.W.1	J. Grose Ltd.	379-381, Euston Road	Euston 5231		
" S.E.18.	Claire & Co. Ltd.	1 and 125, High Street	Woolwich 0174		
" W.5	Kays of Ealing Ltd.	8-10, Bond Street.	Ealing 2387	Sparesokay, Ealux, London.	
" S.E.13	F. Parks & Son Ltd.	404, Lewisham High Street	Lea Green 0535		Speci Compos suppl Automa Associa
" E.8	Eleanor Motors	265/7/9, Mare Street	Amherst 5134		
" E.7	Godfrey's Ltd.	418, Romford Road, Forest Gate	Grangewood 1234	Gofrabike, Forgate.	
" E.6	Godfrey's Ltd.	220, Barking Road, East Ham	Grangewood 8088	Gofrabike, Forgate.	egshie
" N.12	George Grose Ltd.	834, High Road, Finchley	Hillside 2149		
" N.12	Glanfield Lawrence Ltd.	Junction Great North Road and North Circular Road	Finchley 0031	Glanfin, Norphone, London.	
" N.15	Godfreys Ltd.	94 and 96, High Road, Sth Tottenham	Sts 9960	Gofrabike, London.	Tools Sund
" S.E.11	Writers Ltd.	161/5, Kennington Lane	Reliance 1362		
" S.W.11	Owen Bros.	19, Battersea Rise, Clapham Junction	Battersea 7816/7		
" S.W.6	Claude Rye Ltd.	897/921, Fulham Road, Fulham	Renown 6174	Ryeoikes, Wulgreen, London	Elect Equip
" S.W.9	Pride & Clarke Ltd.	Stockwell Road	Brixton 6251		
" S.W.17	Elite Motors (Tooting Ltd.)	951-961, Garratt Lane, Tooting Broad- way	Balham 1200		
" W.12	Turners Stores	81-83, Goldhawk Road, Shepherds Bush	Shepherds Bush 2436		Front a Safety Safery and Let
" W.3	Whitby's of Acton Ltd.	273, The Vale, Acton	Shepherds Bush 5353/6		Sidec Chass



**CLASSIC BIKE SPARES**

Town.	Name of Stockist.	Address.	Telephone No.	Telegraphic Address
London, S.E. 15	West End Motors Ltd.	171, High Street, Peckham	Newcross 2589	
" N.W.10	Stocombes Ltd.	269, Neasden Lane, Neasden	Gladstone 2088 & 0508	
Lowestoft	R. Wright	67-69, London Road South	645	
Macclesfield	A. Watling	49, Buxton Road	3592	
Maidstone	Redhill Motors (Maidstone) Ltd.	The Broadway	3096	
Manchester, 3	Tom Davies (Motors) Ltd.	233, Deansgate	Blackfriars 0681	
"	Fred Fearnley Ltd.	692-4, Ashton Old Road	East 1445/6	Fernbike, Manchester.
" 22	Alex. Parker	31/33, Palestine Road, Northenden	Wythenshaw 2062	
Mansfield	Henstocks	128, Chesterfield Road North	329	Henstock 329 Mansfield.
Middlesbrough	J. T. Dickinson (Middlesbrough) Ltd.	160-162, Lindthorpe Road	3861	Payacob, Middlesbrough.
Neath	Fred Rist	16, Windsor Road	Neath 780	
Newcastle-on-Tyne	Dene (Newcastle) Motor Co. Ltd.	Haymarket	2-9165	Ened, Newcastle-on-Tyne
Newton Abbot	J. E. Green & Co.	87, Queen Street	653	
Newport (Mon.)	R. J. Ware & Sons	69, Commercial Street	66206	
Northampton	P. C. Spokes & Son Ltd.	1, Henry Street	1160	
Norwich	Chapmans (Norwich) Ltd.	38-42, Duke Street	24727	
Nottingham	E. W. Campion & Son Ltd.	Arkwright Street and Queen's Road	83444	
"	Ezra Sugden Ltd.	109, Gateford Road, Worksop	3053	
Oswestry	Roy Evans	Willow <sup>2</sup> Street	1144/5	
Oxford	H. F. Temple	69, High Street, St. Thomas	2485	
"	Faulkner & Son	12, Cardigan Street	57279	
"	John Avery	228/230, Banbury Road	59353	
Parkstone	Bob Foster	472/4, Ashley Road	68	
Perth	M. Shaw & Sons	143, High Street	483	
Peterborough	Burrows Bros.	55-57, Westgate	2154	
Plymouth	P. Pike & Co. Ltd.	Millbay Road	Plymouth 63018	Piko, Plymouth.
Pontardulais	T. Griffiths	Forest Garage	Pontardulais 323	
Portsmouth	Jenkins & Purser Ltd.	277/281, Copnor Road	2339	
"	Glanfield Lawrence	147/157 Fratton Road	74331	
Preston	Loxham's Garages Ltd.	Central Garage, Charnley St., Fishergate	Sales Dept. 4242 Service Dept. 4243	Loxhams, Preston.
Pulborough	Gray & Rowsell	Bury Gate	Bury 4	
Radcliffe	Will Lord	115, Blackburn Street	2002	
Reading	Phillips & Bloomfield Motors Ltd.	10/24, South Street	2635	
"	Stocker & Shepherd Ltd.	131, Oxford Road and Weylen Street	3938	
Redhill	The Redhill Motor and Cycle Works Ltd.	50-54, Brighton Road	327	
Rotherham	Ernest Cross	55/59, Drummond Street	Rotherham 3537	
Salisbury	Pankhurst (Weymouth) Ltd.	78, Exeter Street	Salisbury 5222/3	
Scarborough	E. Andrew	Road Street	Scarborough 1357	



Town.	Name of Stockist	Address	Telephone No.	Telegraphic Address.	E
Sevenoaks	Angus Motor Cycles	Station Parade	3338		
Sheffield, 1	Walter Wragg Ltd.	Stanley Works, Wellington Street	26098	26098 Sheffield	Gea
Shrewsbury	J. R. Meredith	Coleham Head	6529		
Sittingbourne	Scoones' Garage	9, West Street	66	Scoones, Sittingbourne.	
Slough	Sid Moram	Wexham Corner, High Street	Slough 23767		Clut. Fr. Cha
Southampton	Alec Bennett Ltd.	152, Portswood Road	54081-2-3		
Southport	H. F. Brockbank	62, King Street	5054		
Southsea	Percy Kiln	65, Elm Grove, Southsea	Portsmouth 4793		Fr F
St. Helens	Geoff Duke Ltd.	Greenfield Road Garage	3719		
St. Ives	Hallens (Hunts.) Ltd.	The Broadway	St. Ives 3071	Hallens, St. Ives	Fr F
Stockport	Theobald & Coppack	6, Chestergate	2843	Theobald Coppack, Stockport	Fr F
Stoke-on-Trent	J. & N. Bassett	Howards Place, Shelton	2890		
Stourbridge	Pearson's Cycle Depot	31, Market Street	5677		Fr and Fr
Sunderland	Dunns Garage (Sunderland) Ltd.	Wheatsheaf Corner, North Bridge Street	57666		
Swansea	Handel Davies Ltd.	230, Oxford Street	2956		
Swindon	Easters Garage	5, 8, Manchester Road	2788		Rear and Fr
Taunton	W. P. Edwards (Motors) Ltd.	Station Road	2943	Edwards, Motor Cycles Taunton.	Fr
Thames Ditton	Comerfords Ltd.	Oxford House, Portsmouth Road	Emberbrook 5531		
Torquay	P. H. Sharam Ltd.	244, 6 Union Street.	4184 and 7255		Mud O. Tool Cha
Troon	Cooper Bros.	125/129, Templehill	925		
Truro	W. H. Collins	Kenwyn Mews	Truro 2168		
Tunbridge Wells	G. E. Tunbridge	21, London Road	416	Motors, Tunbridge Wells.	Petr Har Dus Batter and
Twickenham	C. A. Blay	192-9, Heath Road	Popesgrove 2103 & 1435		
Uxbridge	J. H. Miles Ltd.	60, High Street	Uxbridge 125		Ear M Tool Chain Rear Co. and S
Wakefield	Parkinsons (Wakefield) Ltd.	38-40, Ings Road	2087		
Walsall	The Motor Cycle Mart (Walsall) Ltd.	12, Ablewell Street	3363		
Warrington	Jack Frodsham Ltd.	37a, Winwick Street	471		Sp Comp is sup Auto Asso
Watford	Lloyd Cooper & Co.	61, Queen's Road	2125	Lloyd Cooper, Watford.	
Westcliff-on-Sea	J. Costin & Sons	233-5-7, London Road	Southend 2215		
Weston-super-Mare	Wyvern's of Weston Ltd.	3, Locking Road	524	Wyvern's, Weston-super-Mare	Legs
Weybridge	W. L. Lewis & Sons	51, Church Street	2210		
Weymouth	Tilleys	9, Frederick Place	72		
Whitehaven	Mark Taylor	21, King's Street	252		Toe Su
Wolverhampton	C. E. Cope & Sons Ltd.	168-9, Stafford Street	24605/6		
Worcester	W. J. Bladder & Son	52, Sidbury	2438	Bladder, Sidbury, Worcester	E E
Worthing	Gray & Rowsell	56, Broadwater Street West	1224		
Yeovil	The Yeovil Motor Mart	Hendford	267		
York	C. S. Russell (York) Ltd.	Lawrence Street	3793	Russell, Lawrence Street, York.	Fr S S and



CLASSIC  
BIKE SPARES



Plate 1.

ENGINE

M20 M21

Plate Ref. Number.	Model.	Part No.	Description.	Number per set.
1	M20, M21	66-421	Engine steady stay	1
—	M20, M21	27-6043	Engine steady stay bolt washer	1
2	M20, M21	2-861	Cylinder head bolt washer	9
3	M20, M21	36-11	Cylinder head bolt (long)	5
4	M20, M21	24-8328	Cylinder head timing bolt	1
5	M20, M21	65-113	Sparking plug	1
—	M20, M21	65-1776	Sparking plug suppressor	1
6	M21 A.A. Model	67-985	Sparking plug waterproof cover and suppressor	1
7	M20, M21	66-102	Sparking plug washer	1
8	M20, M21	36-11	Cylinder head bolt (long)	4
8	M20, M21	66-136	Cylinder head and steady stay bolt	1
9	M20, M21	66-140	Valve guide (inlet)	1
10	M20, M21	66-235	Inlet valve	1
11	M20, M21	66-236	Exhaust valve	1
12	M20, M21	66-139	Valve guide (exhaust)	1
13	M20, M21	66-132	Cylinder barrel	1
14	M20, M21	66-8507	Exhaust lifter cable toggle	1
15	M20, M21	66-1436	Exhaust lifter lever	1
16	M20, M21	2-1584	Exhaust lifter cable toggle screw	1
17	M20, M21	2-443	Exhaust lifter lever nut	1
18	M20, M21	66-2995	Exhaust pipe	1
19	M20, M21	29-541	Exhaust lifter lever washer (shakeproof)	1
20	M20, M21	66-1432	Exhaust lifter lever spring	1
21	M20, M21	66-1434	Exhaust lifter bush	1
22	M20, M21	66-1435	Exhaust lifter	1
23	M20, M21	31-106	Valve spring	2
24	M20, M21	66-221	Valve spring collar	2
25	M20, M21	66-222	Split collar	2
26	M20, M21	66-1498	Exhaust tappet head	1
27	M20, M21	15-6524	Inlet and exhaust tappet locknut	2
28	M20, M21	66-1494	Tappet guide (inlet and exhaust)	2
29	M20, M21	66-1495	Exhaust tappet	1
30	M20, M21	66-243	Valve spring cover washer	1
31	M20, M21	66-242	Valve spring cover	1
32	M20, M21	66-1933	Valve spring cover securing screw	4
33	M20, M21	66-1493	Inlet tappet	1
34	M20, M21	65-692	Engine shaft timing pinion	1
35	M20, M21	65-695	Engine shaft timing pinion locking washer	1
36	M20, M21	29-905	Engine shaft timing pinion nut	1
37	M20, M21	66-1497	Inlet tappet head	1
38	M20, M21	2-77	Crankpin nut locking washer screw	2
39	M20, M21	31-300	Crankpin nut locking washer	2
40	M20, M21	31-298	Crankpin nut	2
41	M20, M21	65-693	Engine shaft timing pinion key	1
42	M20, M21	66-93	Cylinder barrel base joint washer	2
43	M20, M21	2-49	Carburetter stud nut	2
44	M20, M21	36-382	Carburetter stud washer (shakeproof)	2
45	M20, M21	15-5155	Carburetter stud washer (plain)	2
46	M20, M21	66-127	Carburetter flange washer (Hallite)	1
46	M20, M21	66-9251	Carburetter packing piece	1
47	M20, M21	66-9250	Carburetter stud	2
48	M20, M21	3-110	Cylinder base and crankcase stud washer (spring)	5
49	M20, M21	15-152	Cylinder base and crankcase stud nut	5
50	M20, M21	66-58	Cylinder head gasket	1
51	M20, M21	66-59	Cylinder head	1
52	M20, M21	65-479	Crankpin oil hole plug screw	1
53	M20, M21	66-545	Crankpin	1
54	M20, M21	66-506	Crankpin roller cage	1
—	M20, M21	66-477	Connecting rod big end assembly	1
56	M20, M21	66-480	Connecting rod with bushes	1
57	M20, M21	66-491	Gudgeon pin bush	1
58	M20, M21	66-953	Gudgeon pin	1
59	M20	66-1193	Piston complete	1
60	M20, M21	66-1094	Piston ring (top) (Standard)	1
61	M20, M21	66-1244	Piston ring (bottom) (Standard)	1
62	M20, M21	66-1100	Piston scraper ring	1
63	M20, M21	66-661	Engine shaft shim (drive side)	1
64	M20, M21	65-2045	Ball bearing (drive side)	1
65	M20, M21	65-2240	Crankcase bearing spring ring	1
66	M20, M21	66-954	Gudgeon pin circlip	2
67	M20, M21	66-660	Engine shaft distance collar	1

ENGINE  
M20 M21

Engine

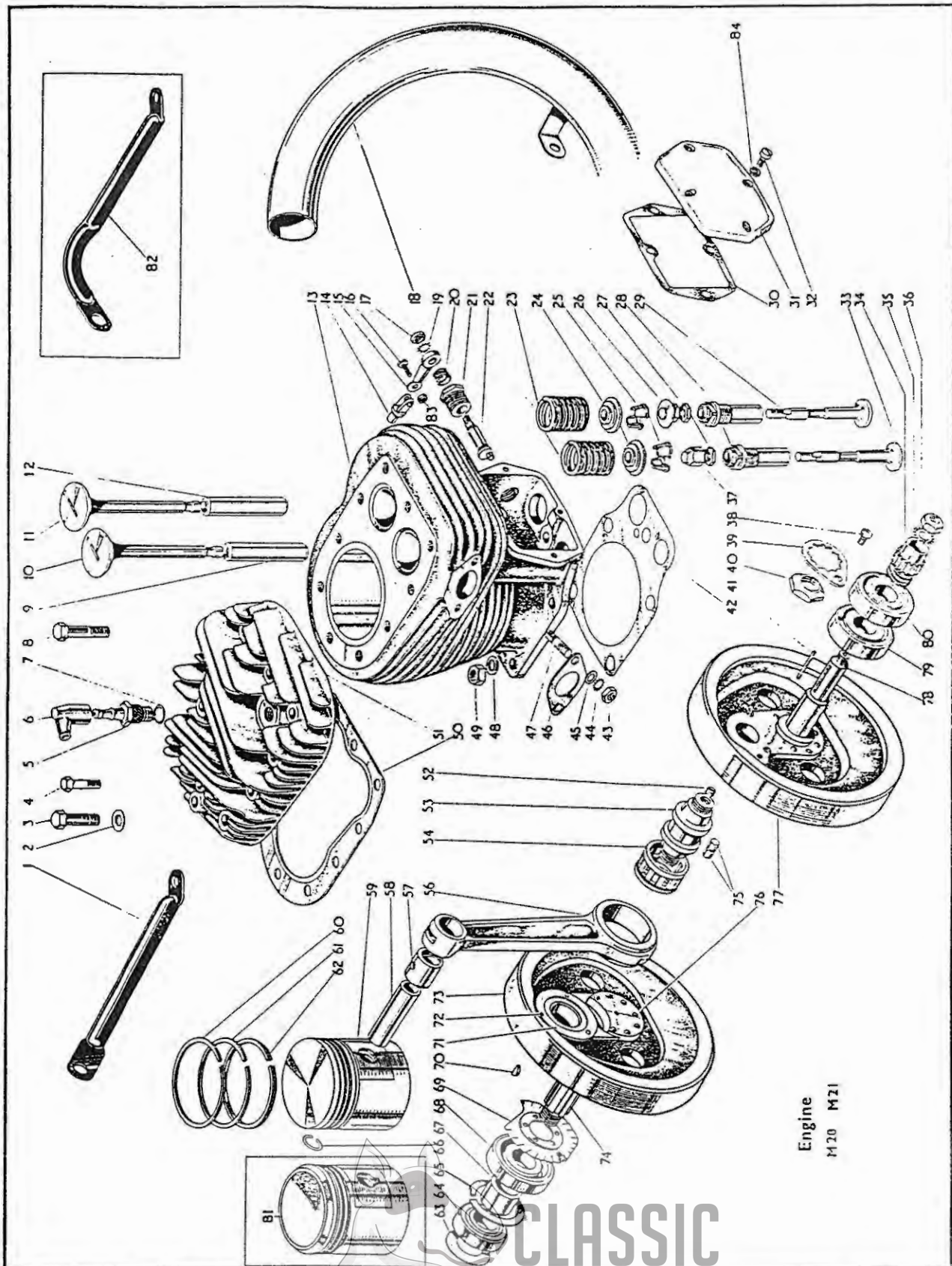

Gearbox

Clutch and  
Front  
Chaincase

Frame and  
Fittings

Front Fork  
and  
Fittings

Front Hub  
and Wheel  
Fittings

Rear Hub  
and Wheel  
Fittings

Mudguards  
Oil Tank  
Toolbox and  
Chainguards

Petrol Tank  
Handlebar  
Dual Seat  
Battery Carrier  
and Silencer

Front Mudguard  
Toolbox  
Chainguards  
Rear Brake  
Control  
and Silencer

Special  
Components  
as supplied to  
Automobile  
Association

Legshields

Tools and  
Sundries

Electrical  
Equipment

Front and Rear  
Safety Bars,  
Safety Bars  
and Legshields

Sidecar  
Chassis

Carrier and  
Pannier

CLASSIC  
BIKE SPARES



Plate 1—continued

ENGINE

M20 M21

Plate Ref. Number.	Model.	Part No.	Description.	Number per set.
68	M20, M21	24-724	Roller bearing (drive side)	1
69	M20, M21	24-2113	Oil flinger	1
70	M20, M21	2-36	Crankpin key	1
71	M20, M21	66-629	Connecting rod thrust washer	2
72	M20, M21	66-630	Connecting rod thrust washer rivet	6
73	M20	66-700	Flywheel (drive side) with shaft assembled	1
73	M21	66-705	Flywheel (drive side) with shaft assembled	1
73	M21 A.A. Model	66-636	Flywheel (drive side) with shaft assembled	1
74	M20, M21	66-644	Engine shaft (drive side)	1
75	M20, M21	24-375	Big end roller	24
76	M20, M21	27-1239	Engine shaft rivet	14
77	M20	66-702	Flywheel (gearside) with shaft assembled	1
77	M21	66-707	Flywheel (gearside) with shaft assembled	1
77	M21 A.A. Model	66-634	Flywheel (gearside) with shaft assembled	1
78	M20, M21	66-640	Engine shaft (gearside)	1
79	M20, M21	24-722	Roller bearing (gearside)	1
80	M20, M21	27-261	Ball bearing (gearside)	1
81	M21	66-1215	Piston complete	1
82	M20, M21	66-306	Engine steady stay (for use when R/H sidecar is fitted)	1
83	M20, M21	2-1584	Exhaust lifter cable toggle screw	1
84	M20, M21	24-978	Valve spring cover securing washer (spring)	4

Plate 2

ENGINE

M20 M21

Plate Ref. Number.	Model.	Part No.	Description.	Number per set.
1	M20, M21	65-2520	Cush drive bearing nut	1
2	M20, M21	65-2521	Cush drive bearing nut lockwasher	1
3	M20	15-46	Cush drive spring (up to 1955)	1
3	M21	66-1706	Cush drive spring (up to 1955)	1
4	M20, M21	15-5155	Cush drive sleeve (up to 1955)	1
5	M20	15-1568	Engine sprocket (16T) (sidecar) (up to 1955)	1
5	M20	15-1566	Engine sprocket (18T) (solo) (up to 1955)	1
5	M21	15-1568	Engine sprocket (16T) (standard) (up to 1955)	1
5	M21	15-1564	Engine sprocket (20T) (solo) (up to 1955)	1
6	M20, M21	65-2523	Cush drive bearing (up to 1955)	1
7	M20, M21	65-2528	Cush drive distance piece (.320"—.325") (as required) (up to 1955)	1
8	M20, M21	*66-1613	Crankcase (drive side) with fixed fittings	1
9	M20, M21	15-1355	Crankcase connecting bolt	3
10	M20, M21	24-1620	Cylinder base and crankcase stud	4
11	M20, M21	66-1627	Cylinder base and crankcase stud	1
12	M20, M21	*66-1601	Crankcase (gear side) with fixed fittings	1
13	M20, M21	2-49	Crankcase connecting bolt nut	5
14	M20, M21	36-3528	Magdyno drive idler pinion thrust washer	1
15	M20, M21	65-2335	Magdyno drive idler pinion spindle	1
16	M20, M21	66-2250	Magdyno drive idler pinion with bush	1
17	M20, M21	65-2336	Magdyno drive idler pinion bush	1
18	M20, M21	65-2425	Cam pinion spindle (inlet)	1
19	M20, M21	65-2426	Cam pinion spindle (exhaust)	1
20	M20, M21	66-2744	Crankcase shield	1
21	M20, M21	65-2420	Cam pinion (inlet and exhaust) with bushes	2
22	M20, M21	65-441	Cam pinion bush (inlet and exhaust)	4
23	M20, M21	66-2008	Timing gear plate with bearing	1
24	M20, M21	36-382	Gear plate bolt washer	2
25	M20, M21	66-2007	Cam pinion spindle bolt	2
26	M20, M21	66-1923	Timing cover all feed washer (rubber)	2
27	M20, M21	66-1920	Timing cover washer	1
28	M20, M21	65-2143	Timing cover	1
29	M20, M21	65-2157	Timing cover screw	9
30	M20, M21	1-4675	Oil valve spring ball	1

\*Supplied only as 66-1612 Crankcase drive side and gear side assembled



ENGINE  
M20 M21

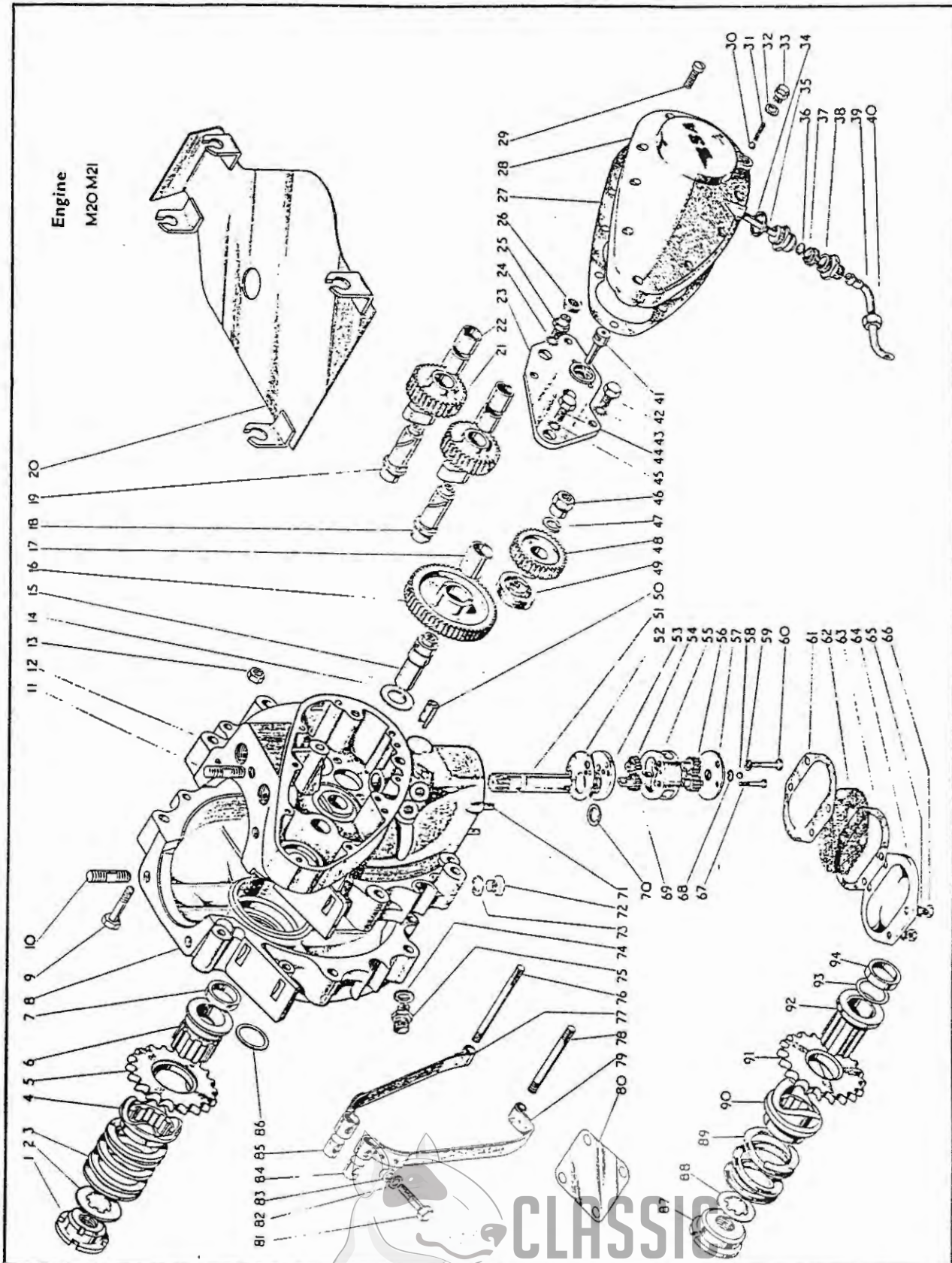

Gearbox

Clutch and Front Chaincase

Frame and Fittings

Front Fork and Fittings

Front Hub and Wheel Fittings

Rear Hub and Wheel Fittings

Mudguards Oil Tank Toolbox and Chainguard

Petrol Tank Handlebar Dual Seat Battery Carrier and Silencer

Rear Mudguard Toolbox Chainguards Rear Brake Control and Silencer

Special Components as supplied to Automobile Association

Legshields

Tools and Sundries

Electrical Equipment

Front and Rear Safety Bars Safety Bars and Legshields

Sidecar Chassis

Carrier and Pannier

CLASSIC  
BIKE SPARES



Plate 2—continued.

ENGINE  
M20 M21

Plate Ref. Number.	Models.	Part No.	Description.	Number per set.
31	M20, M21	66-1684	Oil valve spring	1
32	M20, M21	66-1683	Oil valve spring screw washer	1
33	M20, M21	65-2188	Oil valve spring retaining screw	1
34	M20, M21	31-8430	Air release adaptor washer	1
35	M20, M21	65-2168	Air release adaptor	1
36	M20, M21	15-82	Air release disc	1
37	M20, M21	65-2171	Air release adaptor screw	1
38	M20, M21	65-2165	Air release body	1
39	M20, M21	65-2166	Breather extension pipe	1
40	M20, M21	66-8332	Breather extension pipe nut	1
41	M20, M21	66-698	Engine shaft oil feed pipe	1
42	M20, M21	21-2902	Gear plate bolt (Whit.)	3
43	M20, M21	36-382	Gear plate bolt washer	2
44	M20, M21	1-5069	Gear plate bolt (C.E.I.)	1
45	M20, M21	36-382	Gear plate bolt washer	2
46	M20, M21	24-195	Magdyno driving pinion nut	1
47	M20, M21	2-2903	Magdyno driving pinion washer	1
48	M20, M21	65-2334	Magdyno driving pinion	1
49	M20, M21	65-2316	Magdyno driving pinion oil seal	1
50	M20, M21	65-2580	Oil pump spindle retaining pin	1
51	M20, M21	66-2620	Oil pump driving spindle	1
52	M20, M21	65-2618	Oil pump crankcase joint washer	1
53	M20, M21	65-2598	Oil pump top plate	1
54	M20, M21	*65-2600	Oil pump feed gear (driven)	1
55	M20, M21	65-2596	Oil pump body	1
56	M20, M21	*65-2599	Oil pump scavenge gear	2
57	M20, M21	65-2625	Oil pump bottom plate with ball valve	1
58	M20, M21	65-2593	Oil pump valve steel ball	1
59	M20, M21	24-978	Oil pump fixing spring washer	2
60	M20, M21	65-2604	Oil pump fixing bolt	2
61	M20, M21	65-2612	Crankcase scavenge cover washer	2
62	M20, M21	65-2623	Oil pump filter	1
63	M20, M21	65-2612	Crankcase scavenge cover washer	2
64	M20, M21	65-2611	Crankcase scavenge cover	1
65	M20, M21	29-541	Scavenge cover stud washer	4
66	M20, M21	2-51	Scavenge cover stud nut	4
67	M20, M21	15-848	Oil pump bolt...	2
68	M20, M21	65-2622	Oil pump valve circlip	1
69	M20, M21	*65-2601	Oil pump feed gear (driver)	1
70	M20, M21	65-2606	Oil pump top plate washer	1
71	M20, M21	31-222	Scavenge cover stud...	4
72	M20, M21	28-243	Drain plug (crankcase)	1
73	M20, M21	2-4553	Drain plug washer	1
74	M20, M21	66-1683	Crankcase oil pipe washer (fibre)	2
75	M20, M21	65-2252	Crankcase oil pipe adaptor	2
76	M20, M21	31-212	Crankcase connecting stud (top) (rear)	1
77	M20, M21	66-2353	Magdyno strap complete (short)	1
78	M20, M21	24-949	Crankcase connecting stud (rear)	1
79	M20, M21	66-2355	Magdyno strap complete (long)	1
80	M20, M21	66-2347	Magdyno packing washer (.005")	as reqd.
80	M20, M21	66-2348	Magdyno packing washer (.010")	as reqd.
81	M20, M21	27-5156	Magdyno strap clip bolt	1
82	M20, M21	2-923	Magdyno strap clip bolt washer	1
83	M20, M21	29-4662	Magdyno strap clip bolt saddle washer	1
84	M20, M21	65-2352	Magdyno strap eye plug (plain)	1
85	M20, M21	65-2353	Magdyno strap eye plug (tapped)	1
86	M20, M21	66-1707	Cush drive bearing alignment washer (.032")	as reqd.
86	M20, M21	66-1708	Cush drive bearing alignment washer (.004")	as reqd.
87	M20, M21	65-2520	Cush drive nut	1
88	M20, M21	65-2521	Cush drive nut locking washer	1
89	M20, M21	67-1136	Cush drive spring	1
90	M20, M21	67-1135	Cush drive sleeve	1
91	M20	67-1132	Engine sprocket (18T solo)	1
91	M20, M21	65-2536	Engine sprocket (16T sidecar)	1
91	M21	65-2538	Engine sprocket (20T solo)	1
92	M20, M21	65-2539	Cush drive bearing	1
93	M20, M21	66-1707	Cush drive bearing alignment washer	as reqd.
93	M20, M21	66-1708	Cush drive bearing alignment washer	as reqd.
94	M20, M21	65-2540	Cush drive distance piece	1

\*65-2599 replaced by 65-2590

\*65-2600 replaced by 65-2591

\*65-2601 replaced by 65-2592

For replacement purposes these gears are only supplied in sets of four.

Plate Ref. Number.	Model.	Part No.	Description.	Number per set.
1	M33	65-1707	Cylinder barrel	1
2	M33	66-86	Cylinder base shim	1
3	M33	66-92	Cylinder base washer (up to 1955)	1
4	M33	65-930	Push rod cover tube stud nut	2
5	M33	29-541	Push rod cover tube stud spring washer	2
6	M33	24-4227	Push rod cover tube stud	2
7	M33	66-1379	Push rod cover tube bottom washer	1
8	M33	66-1937	Push rod tappet recess cover washer	1
9	M33	66-1936	Push rod tappet recess cover	1
10	M33	29-2158	Push rod tappet recess cover screw	4
11	M33	66-115	Cylinder holding down bolt complete	4
12	M33	65-1084	Push rod complete	2
13	M33	65-1080	Push rod cover tube	1
14	M33	65-1142	Valve rocker inspection cover	1
15	M33	2-2582	Valve rocker inspection cover screw	4
16	M33	65-1143	Valve rocker inspection cover washer	1
17	M33	66-2998	Exhaust pipe complete	1
18	M33	65-1240	Exhaust valve...	1
19	M33	65-1516	Exhaust valve guide	1
20	M33	65-1149	Valve spring collar	2
21	M33	15-1525	Valve spring split collar (exhaust)	2 halves
22	M33	66-2967	Exhaust pipe finned collar	1
23	M33	65-1160	Cylinder head cover (exhaust) (right-hand)	1
24	M33	2-443	Exhaust lifter cable holder nut	1
25	M33	27-1163	Exhaust lifter cable holder	1
26	M33	2-443	Exhaust lifter spindle nut	1
27	M33	2-525	Exhaust lifter washer	1
28	M33	65-1137	Exhaust lifter	1
29	M33	35-701	Exhaust lifter spindle split pin	1
30	M33	65-1165	Exhaust lifter spindle	1
31	M33	2-2894	Exhaust lifter bush washer (fibre)	1
32	M33	65-387	Exhaust lifter bush	1
33	M33	65-401	Exhaust lifter spindle washer (felt)	1
34	M33	65-402	Exhaust lifter spindle washer	1
35	M33	65-403	Exhaust lifter spindle spring	1
36	M33	66-1436	Exhaust lifter lever	1
37	M33	2-443	Exhaust lifter spindle nut	1
38	M33	2-525	Exhaust lifter washer	1
39	M33	65-317	Rocker oil feed pipe banjo screw	2
40	M33	66-102	Sparking plug washer	1
41	M33	65-114	Sparking plug	1
42	M33	65-1776	Sparking plug suppressor	1
43	M33	65-1660	Piston (7.5 to 1 C.R.) complete with rings, gudgeon pin and circlips	1
44	M33	15-1525	Valve spring split cotter (inlet)	2 halves
45	M33	65-1149	Valve spring collar	2
46	M33	31-8430	Rocker feed pipe top union washer	2
47	M33	65-1161	Valve rocker fulcrum pin	2
48	M33	65-1146	Valve spring (inner)	2
49	M33	65-1147	Valve spring (outer)	2
50	M33	65-1515	Inlet valve guide	1
51	M33	65-1118	Valve rocker fulcrum pin washer	2
52	M33	65-1117	Valve rocker fulcrum spring	2
53	M33	65-1102	Valve rocker (inlet)	1
53B	M33	65-1100	Valve rocker (exhaust)	1
54	M33	27-1111	Valve rocker fulcrum pin thrust washer	2
55	M33	29-541	Cylinder head cover screw washer	8
56	M33	65-1166	Cylinder head cover screw	1
57	M33	65-1704	Cylinder head with fixed fittings	1
58	M33	36-481	Valve rocker fulcrum pin nut washer	2
59	M33	65-311	Valve rocker fulcrum pin nut	2
60	M33	66-1367	Push rod cover tube gland packing	1
61	M33	65-1082	Push rod cover tube gland nut	1
62	M33	2-49	Carburettor stud nut	2
63	M33	36-382	Carburettor stud nut washer	2
64	M33	24-5205	Carburettor stud	2
65	M33	65-1238	Carburettor flange washer (Tufnol)	1
66	M33	65-1232	Carburettor flange washer (paper)	1
67	M33	65-1164	Cylinder head cover washer (paper)	1
68	M33	65-1159	Cylinder head cover (inlet) (left-hand)	1
69	M33	26-1253	Oil return pipe banjo screw	1
70	M33	65-1218	Oil return pipe	1

Gearbox

Clutch and Front Chaincase

Frame and Fittings

Front Fork and Fittings

Front Hub and Wheel Fittings

Rear Hub and Wheel Fittings

Mudguards Oil Tank Toolbox and Chainguards

Petrol Tank Handlebar Dual Seat Battery Carrier and Silencer

Rear Mudguard Toolbox Chainguards Rear Brake Control and Silencer

Special Components as supplied to Automobile Association

Legshields

Tools and Sundries

Electrical Equipment

Front and Rear Safety Bars, Safety Bars and Legshields

Sidcar Chassis

Carrier and Pannier





ENGINE  
M33

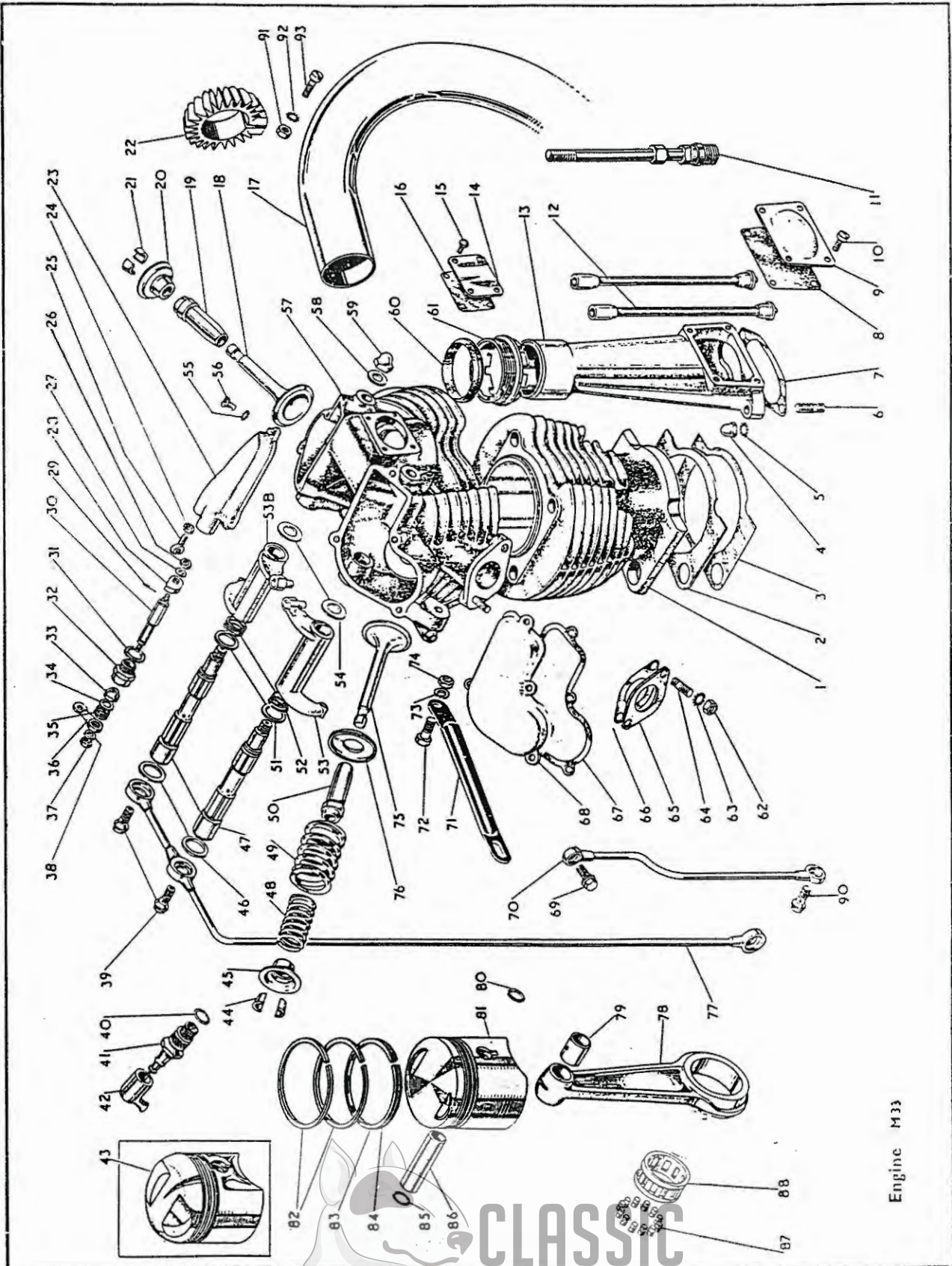

Engine M33

CLASSIC  
BIKE SPARES



Plate 3—continued

ENGINE

M33

Plate Ref. Number.	Model.	Part No.	Description.	Number per set.
71	M33	66-147	Engine steady stay	1
72	M33	15-480	Engine steady stay bolt (up to 1955)	1
73	M33	24-8784	Engine steady stay bolt washer (up to 1955)	1
74	M33	2-49	Engine steady stay bolt nut (up to 1955)	1
75	M33	65-1239	Inlet valve	1
76	M33	65-1519	Valve spring seat	2
77	M33	65-1544	Rocker oil feed pipe complete	1
78	M33	65-1613	Connecting rod with bushes	1
79	M33	66-492	Connecting rod gudgeon pin bush	1
80	M33	66-954	Gudgeon pin retaining ring	1
81	M33	65-1692	Piston complete (6.5 to 1 C.R.) (up to 1955)	1
82	M33	65-1250	Piston ring	2
83	M33	65-1253	Piston scraper ring	1
84	M33	24-1792	Piston scraper ring (Maxigroove) (up to 1955)	1
85	M33	66-954	Gudgeon pin retaining ring	1
86	M33	66-953	Gudgeon pin	1
87	M33	24-375	Crankpin roller	24
88	M33	66-506	Crankpin roller cage	1
90	M33	26-1253	Oil return pipe banjo screw	1
91	M33	21-5102	Exhaust pipe finned collar nut	1
92	M33	29-541	Exhaust pipe finned collar washer	1
93	M33	21-6187	Exhaust pipe finned collar screw	1

Gearbox

Clutch and Front Chaincase

Frame and Fittings

Front Fork and Fittings

Front Hub and Wheel Fittings

Rear Hub and Wheel Fittings

Mudguards Oil Tank Toolbox and Chainguard

Petrol Tank Handlebar Dual Seat Battery Carrier and Silencer

Rear Mudguard Toolbox Chainguards Rear Brake Control and Silencer

Special Components is supplied to Automobile Association

Legshields

Tools and Sundries

Electrical Equipment

Front and Rear Safety Bars Safety Bars and Legshields

Sidecar Chassis

Carrier and Pannier

Plate 4

ENGINE

M33

Plate Ref. Number.	Models.	Part No.	Description.	Number per set.
1	M33	1-4675	Oil valve spring ball	1
2	M33	66-1684	Oil valve spring	1
3	M33	66-1683	Oil valve spring retaining screw washer	1
4	M33	65-2188	Oil valve spring retaining screw	1
5	M33	65-2157	Timing cover screw	9
6	M33	65-2143	Timing cover complete	1
7	M33	66-1920	Timing cover washer	1
8	M33	66-698	Engine shaft oil feed pipe	1
9	M33	29-905	Engine shaft timing pinion nut	1
10	M33	66-1923	Oil feed rubber washer	2
11	M33	66-2007	Cam pinion spindle bolt	2
12	M33	66-2008	Timing gear plate complete	1
13	M33	65-441	Cam pinion bush	2
14	M33	65-2420	Cam pinion (exhaust)	1
15	M33	65-2426	Cam pinion spindle (exhaust)	1
16	M33	65-692	Engine shaft timing pinion	1
17	M33	66-1493	Inlet and exhaust tappet	2
18	M33	66-1494	Inlet and exhaust tappet guide	2
19	M33	65-1332	Inlet and exhaust tappet locknut	2
20	M33	66-1511	Inlet and exhaust tappet head	2
21	M33	*66-1616	Crankcase (gear side) with fixed fittings	1
22	M33	31-212	Crankcase stud (top) (rear)	1
23	M33	66-2353	Magdyno strap (short) complete	1
23	M33	66-2327	Magneto strap (front) (up to 1955)	1
24	M33	65-2353	Magdyno strap eye plug (tapped)	1
25	M33	66-2355	Magdyno strap (long) complete	1
25	M33	66-2343	Magneto strap (rear) (up to 1955)	1
26	M33	65-2352	Magdyno strap eye plug (plain)	1
27	M33	29-4662	Magdyno strap bolt saddle washer	1
28	M33	2-923	Magdyno strap bolt washer	1
29	M33	27-5156	Magdyno strap clip bolt	1
30	M33	*66-1642	Crankcase (drive side) with fixed fittings	1
31	M33	15-1355	Crankcase connecting bolt	3
32	M33	24-949	Crankcase stud (rear)	1
33	M33	66-1683	Oil valve spring retaining screw washer	1
34	M33	65-2252	Oil pipe crankcase pipe adaptor	1

\*Supplied only as 66-1644 Crankcase drive side and gear side assembled



ENGINE  
M33

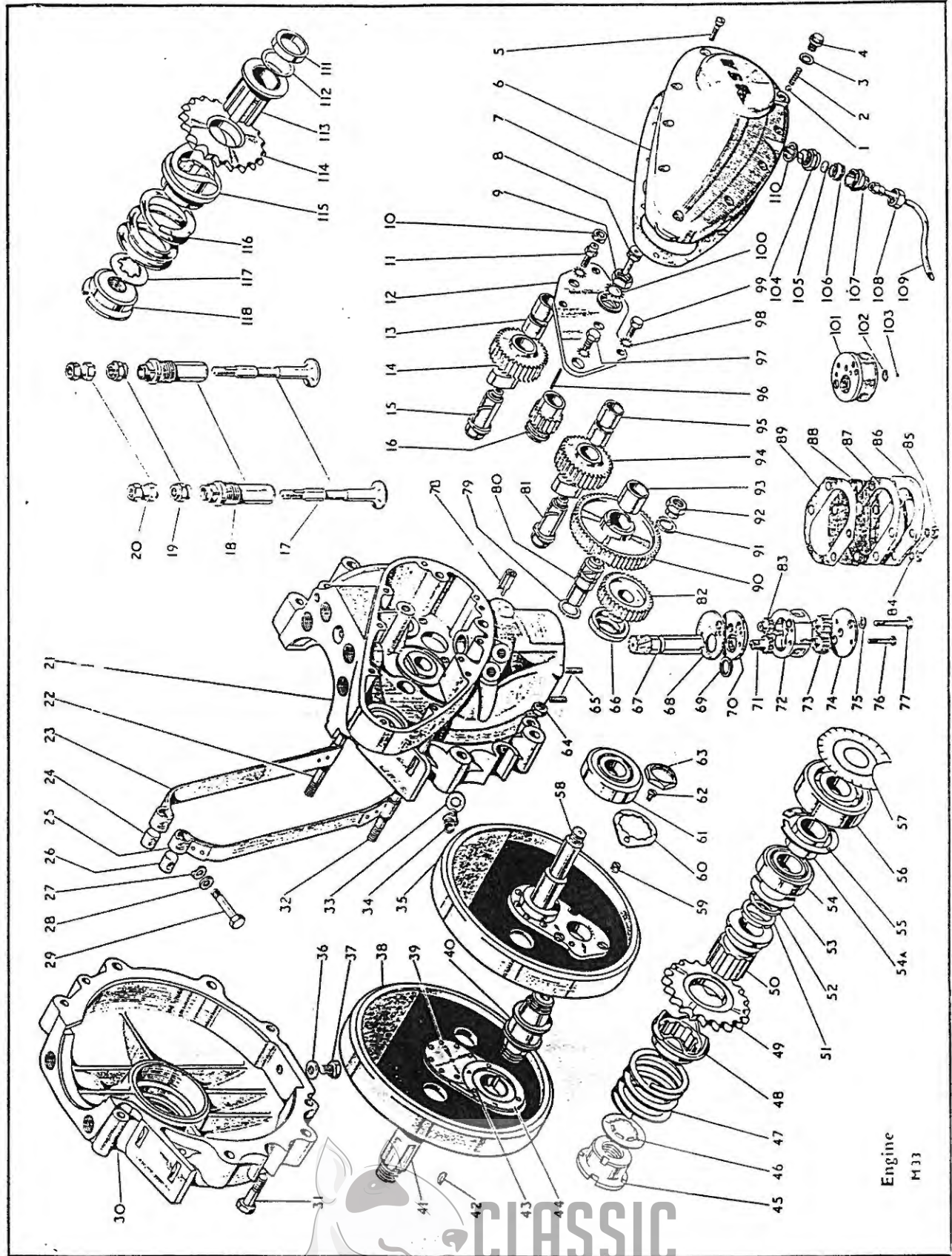

Engine  
M33



ENGINE

M33

Plate Ref. Number.	Models.	Part No.	Description.	Number per set	Gearbox
35	M33	65-1235	Flywheel (gear side) with shaft assembled	1	
35	M33	65-1742	Flywheel (gear side) with shaft assembled (up to 1955)	1	
36	M33	2-4553	Crankcase drain plug washer	1	Clutch and Front Chaincase
37	M33	28-243	Crankcase drain plug	1	
38	M33	65-1740	Flywheel (drive side) with shaft assembled (up to 1955)	1	
38	M33	65-1233	Flywheel (drive side) with shaft assembled	1	
39	M33	27-1239	Engine shaft rivet	14	
40	M33	66-545	Crankpin	1	Frame and Fittings
41	M33	65-1128	Engine shaft (drive side)	1	
42	M33	2-36	Crankpin key	1	
43	M33	66-630	Connecting rod thrust washer rivet	6	
44	M33	66-629	Connecting rod thrust washer	2	
45	M33	65-2520	Cush drive bearing nut	1	
46	M33	65-2521	Cush drive bearing nut lockwasher	1	Front Fork and Fittings
47	M33	66-1706	Cush drive spring (1954)	1	
48	M33	15-1555	Cush drive sleeve (1954)	1	
49	M33	15-1564	Engine sprocket (20T) (solo) (1954)	1	
49	M33	15-1567	Engine sprocket (17T) (sidecar) (1954)	1	
50	M33	65-2523	Cush drive bearing (1954)	1	Front Hub and Wheel Fittings
51	M33	65-2528	Cush drive distance piece (.320"—.325") (up to 1955)	as reqd.	
52	M33	66-1707	Cush drive bearing alignment washer (.032")	as reqd.	
52	M33	66-1708	Cush drive bearing alignment washer (.064")	as reqd.	
53	M33	66-661	Engine shaft shim (drive side)	1	
54	M33	65-2045	Ball bearing (drive side)	1	
54A	M33	66-660	Engine shaft distance collar	1	Rear Hub and Wheel Fittings
55	M33	65-2240	Main bearing spring ring	1	
56	M33	24-724	Roller bearing (drive side)	1	
57	M33	24-2113	Oil flinger	1	
58	M33	65-1129	Engine shaft (gearside)	1	
59	M33	65-479	Crankpin oil hole plug screw	1	
60	M33	31-300	Crankpin nut lockwasher	2	Mudguards Oil Tank Toolboxes and Chainguards
61	M33	24-722	Roller bearing (gearside)	1	
62	M33	2-77	Crankpin nut locking washer screw	2	
63	M33	31-298	Crankpin nut	2	
64	M33	2-49	Crankcase connecting bolt nut	5	
65	M33	31-222	Crankcase scavenge cover stud	4	Petrol Tank Handlebar Dual Seat Battery Carrier and Silencer
66	M33	65-2316	Magdyno driving pinion oil seal	1	
67	M33	66-2620	Oil pump driving spindle	1	Ear Mudguard Toolbox Chainguards Rear Brake Control and Silencer
68	M33	65-2618	Oil pump and crankcase joint washer	1	
69	M33	65-2606	Oil pump top plate washer	1	
70	M33	65-2598	Oil pump top plate	1	
71	M33	*65-2601	Oil pump feed gear (driver)	1	
72	M33	65-2596	Oil pump body	1	
73	M33	*65-2599	Oil pump scavenge gear	2	
74	M33	65-2625	Oil pump bottom plate with valve body circlip and steel ball	1	
75	M33	24-978	Oil pump fixing bolt washer	2	
76	M33	15-848	Oil pump bolt	2	Special Components as supplied to Automobile Association
77	M33	65-2604	Oil pump fixing bolt	2	
78	M33	65-2580	Oil pump driving spindle retaining pin	1	
79	M33	36-3528	Magdyno drive idler pinion thrust washer	1	
80	M33	65-2335	Magdyno drive idler pinion spindle	1	
81	M33	65-2425	Cam pinion spindle (inlet)	1	
82	M33	65-2334	Magdyno driving pinion	1	Legshields
83	M33	*65-2600	Oil pump feed gear (driven)	1	
84	M33	29-541	Crankcase scavenge cover stud washer	4	
85	M33	2-51	Crankcase scavenge cover stud nut	4	
86	M33	65-2611	Crankcase scavenge cover	1	
87	M33	65-2612	Crankcase scavenge cover washer	2	
88	M33	65-2623	Oil pump filter	1	Tools and Sundries
89	M33	65-2612	Crankcase scavenge cover washer	2	
90	M33	66-2250	Magdyno drive idler pinion	1	
91	M33	2-2903	Magdyno driving pinion washer	1	
92	M33	24-195	Magdyno driving pinion nut	1	
93	M33	65-2336	Magdyno drive idler pinion bush	1	Electrical Equipment
94	M33	65-2425	Cam pinion (inlet)	1	
95	M33	65-441	Cam pinion bush	2	
96	M33	65-693	Engine shaft timing pinion key	1	
97	M33	1-5069	Timing gear plate bolt (C.E.I.)	1	
98	M33	36-382	Timing gear plate bolt washer	6	Front and Rear Safety Bars, Safety Bars and Legshields
99	M33	21-2902	Timing gear plate bolt (Whit.)	3	
100	M33	65-695	Pinion locking washer	1	

\*65-2601 replaced by 65-2592

\*65-2599 replaced by 65-2590

\*65-2600 replaced by 65-2591

For replacement purposes these gears are only supplied in sets of four.



Sidecar Chassis  
Carrier a Pannier



## Plate 4—continued

## ENGINE

M33

Plate Ref. Number.	Models.	Part No.	Description.	Number per set.
101	M33	65-2589	Oil pump complete	1
102	M33	65-2622	Oil pump valve body circlip	1
103	M33	65-593	Oil pump valve body steel ball	1
104	M33	65-2168	Timing cover air release adaptor complete	1
105	M33	15-82	Air release disc	1
106	M33	65-2171	Air release adaptor screw	1
107	M33	65-2165	Timing cover air release body	1
108	M33	66-8332	Timing cover breather extension pipe nut	1
109	M33	65-2166	Timing cover breather extension pipe complete	1
110	M33	31-8430	Air release adaptor washer (fibre)	1
111	M33	65-2540	Cush drive distance piece (1955 Models)	1
112	M33	66-1707	Cush drive bearing alignment washer	as reqd.
112	M33	66-1708	Cush drive bearing alignment washer	as reqd.
113	M33	65-2539	Cush drive bearing	1
114	M33	65-2537	Engine sprocket (17T) (sidecar)	1
114	M33	65-2538	Engine sprocket (20T) (solo)	1
115	M33	67-1135	Cush drive sleeve	1
116	M33	67-1136	Cush drive spring	1
117	M33	65-2521	Cush drive nut locking washer	1
118	M33	65-2520	Cush drive nut	1

## Plate 5

## GEARBOX

"M" Group

Plate Ref. Number.	Model.	Part No.	Description.	Number per set.
1	M Group	24-4226	Gearbox sprocket locknut	1
2	M Group	24-4263	Gearbox sprocket nut lockwasher	1
3	M Group	65-3506	Gearbox sprocket (19T)	1
4	M Group	66-3140	Gearbox with fixed fittings	1
5	M Group	24-4288	Gearbox oil baffle	1
6	M Group	15-4110	Gearbox inspection cover washer	2
7	M Group	27-4258	Gearbox inspection cover screw	4
8	M Group	66-3070	Gearbox inspection cover	1
9	M Group	65-3508	Gearbox sprocket oil seal	1
10	M Group	65-3509	Gearbox sprocket oil seal washer	1
11	M Group	24-4065	Gearbox ballrace	1
12	M Group	66-3086	Gear control shaft packing washer	as reqd.
13	M Group	66-3084	Gear control shaft bush	1
14	M Group	66-3290	Gear operating fork	1
15	M Group	66-3291	Gear control shaft peg	2
16	M Group	66-3290	Gear operating fork	1
—	M Group	66-3288	Gear control shaft with forks	1
17	M Group	66-3083	Gear control shaft	1
18	M Group	24-4245	Gear control shaft bush (inner cover)	1
19	M Group	66-3087	Gear control shaft bush packing washer	as reqd.
20	M Group	15-4223	Indexing plunger sleeve	1
21	M Group	15-4225	Indexing plunger spring	1
22	M Group	15-4224	Indexing plunger	1
23	M Group	2-440	Operating shaft nut	1
24	M Group	15-39	Operating shaft washer	1
25	M Group	15-4226	Pedal shaft bush	1
26	M Group	15-4229	Operating shaft	1
—	M Group	15-4231	Operating plate	1
27	M Group	2-49	Operating plate and pawl arm stop screw nut	2
28	M Group	36-382	Operating plate and pawl arm stop washer	2
29	M Group	15-4228	Operating plate and pawl arm stop	1
30	M Group	2-2211	Operating plate and pawl arm stop screw	2
31	M Group	15-4139	Pawl carrier arm main spring	1
32	M Group	15-4138	Pawl pivot	2
33	M Group	15-4243	Pawl carrier arm (bottom) (complete)	1
34	M Group	15-4242	Pawl carrier arm (top) (complete)	1
35	M Group	15-4161	Pawl return spring	1
36	M Group	15-4141	Pawl (top)	1

CLASSIC  
BIKE SPARES

GEARBOX  
"M" Group

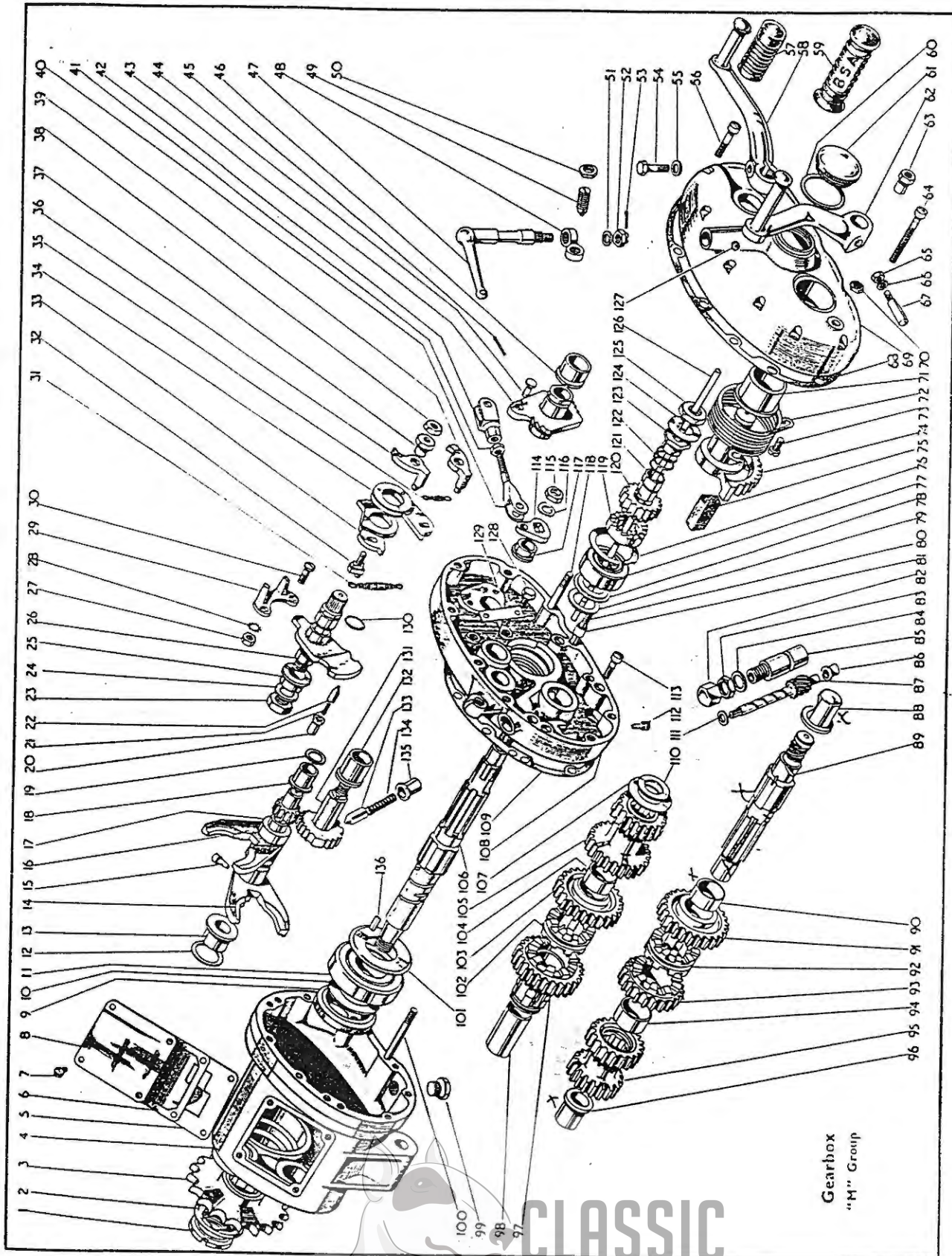

Gearbox

Clutch and Front Chaincase

Frame and Fittings

Front Fork and Fittings

Front Hub and Wheel Fittings

Rear Hub and Wheel Fittings

Mudguards Oil Tank Toolbox and Chainguards

Petrol Tank Handlebar Dual Seat Battery Carrier and Silencer

Rear Mudguard Toolbox Chainguards Rear Brake Control and Silencer

Special Components as supplied to Automobile Association

Legshields

Tools and Sundries

Electrical Equipment

Front and Rear Safety Bars Safety Bars and Legshields

Sidecar Chassis

Carrier and Pannier



GEARBOX

"M" Group

Plate Ref. Number	Models	Part No.	Description	Number per set
37	M Group	15-4143	Pawl pivot nut	2
38	M Group	2-2395	Pawl pivot locknut	2
39	M Group	15-4142	Pawl (bottom)	1
40	M Group	15-4253	Gear control link complete	1
40	M Group	15-4255	Gear control link adjuster	1
41	M Group	24-563	Gear control link adjuster locknut	1
42	M Group	15-4254	Gear control link yoke	1
43	M Group	15-4206	Ratchet lever complete	1
44	M Group	15-4221	Gear control link pin	2
45	M Group	35-705	Gear control link pin split pin	2
46	M Group	15-4227	Ratchet lever sleeve bush	1
47	M Group	65-3383	Clutch control lever complete	1
48	M Group	65-3360	Clutch push rod lever	1
49	M Group	65-3403	Clutch push rod lever adjusting screw complete	1
50	M Group	2-452	Clutch push rod lever adjusting screw nut	1
51	M Group	2-525	Clutch control lever nut washer	1
52	M Group	15-1485	Clutch control lever nut	1
53	M Group	35-702	Clutch control lever split pin	1
54	M Group	65-3361	Operating pedal clamp bolt...	1
55	M Group	2-525	Operating pedal clamp bolt washer	1
56	M Group	66-3065	Gearbox outer and inner cover screw	3
57	M Group	29-3250	Operating pedal spindle rubber	1
58	M Group	65-3417	Gear change operating lever complete	1
59	M Group	65-3212	Kickstarter crank rubber	1
60	M Group	67-41	Outer cover inspection cap washer	1
61	M Group	65-3364	Outer cover inspection cap	1
62	M Group	15-4179	Kickstarter crank complete	1
63	M Group	29-3242	Gearbox outer cover stud nut	4
64	M Group	65-3062	Gearbox cover and case screw	4
65	M Group	2-2578	Kickstarter crank cotter pin nut	1
66	M Group	15-5155	Kickstarter crank cotter pin washer	1
67	M Group	2-2579	Kickstarter crank cotter pin	1
68	M Group	66-3131	Outer cover joint washer	1
69	M Group	66-3125	Gearbox outer cover with fixed fittings	1
70	M Group	2-443	Kickstarter crank pin anchor pin nut	1
71	M Group	24-4258	Kickstarter quadrant bush	1
72	M Group	66-3058	Kickstarter crank spring	1
73	M Group	2-3718	Kickstarter crank spring anchor pin	1
74	M Group	15-4121	Kickstarter quadrant...	1
75	M Group	66-3259	Kickstarter return stop rubber	1
76	M Group	67-3028	Gearbox inner cover ball journal spring ring	1
77	M Group	24-4217	Gearbox inner cover ball journal	1
78	M Group	24-4236	Gearbox retaining washer (small)	1
79	M Group	24-4237	Gearbox distance washer	1
80	M Group	65-3073	Gearbox outer cover stud	1
81	M Group	66-3074	Gearbox dowel	2
82	M Group	65-3399	Speedometer gear bush sealing nut (fitted when speedo not required)	1
83	M Group	65-3391	Speedometer driven gear bush nut	1
84	M Group	65-3392	Speedometer driven gear bush sealing nut washer (when speedo not fitted).	1
85	M Group	65-3390	Speedometer driven gear bush	1
86	M Group	65-3377	Speedometer driven gear bush (small)	1
87	M21, M33	65-3367	Speedometer driven gear	1
87	M20	65-3402	Speedometer driven gear	1
88	M Group	66-3133	Gearbox layshaft bush (long)	1
89	M21, M33	66-3132	Gearbox layshaft	1
89	M20	65-3498	Gearbox layshaft	1
90	M Group	66-3214	Mainshaft gear bush	1
91	M Group	66-3209	Gearbox layshaft gear complete (29T)	1
91	M Group	66-3211	Gearbox layshaft gear bush	1
92	M Group	24-4393	Gearbox dog clutch	1
93	M Group	66-3215	Gearbox layshaft gear complete (25T)	1
94	M Group	66-3214	Gearbox layshaft gear bush	1
95	M Group	24-4221	Gearbox layshaft gear (17T and 20T)	1
96	M Group	24-4223	Gearbox layshaft bush (short)	1
97	M Group	15-4165	Pinion sleeve complete	1
98	M Group	66-3155	Pinion sleeve bush	1
98	M Group	66-3156	Pinion sleeve bush (drilled)	1
99	M Group	28-43	Gearbox drain plug	1
100	M Group	29-3304	Gearbox outer cover stud (long)	2
101	M Group	24-4225	Gearbox oil retaining washer	1



Plate 5—continued

GEARBOX

"M" Group

Plate Ref. Number.	Models.	Part No.	Description.	Number per set.
102	M Group	24-4393	Gearbox dog clutch	1
103	M Group	66-3212	Mainshaft gear complete (25T)	1
104	M Group	66-3214	Mainshaft gear bush	1
105	M Group	24-4231	Mainshaft gear (20T and 16T)	1
106	M Group	15-4260	Gearbox mainshaft	1
107	M Group	24-4235	Gearbox oil flinger washer	1
108	M Group	66-3128	Inner cover complete with fixed fittings	1
109	M Group	66-3069	Inner joint washer	1
110	M Group	66-3071	Mainshaft packing washer (.005")	as reqd.
110	M Group	66-3072	Mainshaft packing washer (.010")	as reqd.
111	M Group	65-3375	Speedometer driven gear thrust washer	1
112	M Group	65-3400	Speedometer bush retaining pin	1
113	M Group	65-2157	Inner cover and case screw	3
114	M Group	15-4239	Gear operating lever	1
115	M Group	2-1813	Gear operating lever nut	1
116	M Group	15-4232	Gear operating lever locking washer	1
117	M Group	15-4233	Gear control quadrant spacing collar	1
118	M Group	66-1910	Gearbox outer cover stud	1
119	M Group	66-3079	Kickstarter ratchet	1
120	M Group	66-3080	Kickstarter ratchet pinion	1
121	M Group	66-3081	Kickstarter ratchet pinion sleeve	1
122	M Group	24-4256	Kickstarter ratchet spring	1
123	M Group	24-4282	Kickstarter ratchet pinion sleeve nut	1
124	M Group	24-4278	Kickstarter ratchet pinion locking washer	1
125	M Group	24-4255	Kickstarter ratchet pinion sleeve locknut	1
126	M Group	66-3067	Clutch push rod	1
126	AA Model	29-3324	Clutch push rod	1
126	AA Model	65-3943	Clutch push rod	1
127	M Group	28-2080	Grease nipple	1
128	M Group	21-2888	Inner cover and case screw	2
129	M Group	15-4246	Inner cover and case locking strip	1
130	M Group	15-4240	Operating shaft clip ring	1
131	M Group	24-4247	Gear control quadrant	1
132	M Group	24-4248	Gear control quadrant bush	1
133	M Group	15-4035	Gear control plunger	1
134	M Group	24-68	Gear control plunger spring	1
135	M Group	24-4251	Gear control plunger cup	1
136	M Group	2-433	Gearbox key (mainshaft)	1

Clutch and Front Chaincase

Frame and Fittings

Front Fork and Fittings

Front Hub and Wheel Fittings

Rear Hub and Wheel Fittings

Mudguards Oil Tank Toolbox and Chainguards

Petrol Tank Handlebar Dual Seat Battery Carrier and Silencer

Rear Mudguard Chainguards Rear Brake Control and Silencer

Special Components as supplied to Automobile Association

Legshields

Tools and Sundries

Electrical Equipment

Front and Rear Safety Bars and Legshields

Sidecar Chassis

Carrier and Pannier

Plate 6

CLUTCH and FRONT CHAINCASE

"M" Group

Plate Ref. Number.	Model.	Part No.	Description.	Number per set.
1	M20, M21, M33 (rigid and spring)	65-7594	Chaincase (front) with fixed fittings	1
1	M20 AA Model	65-7594	Chaincase (front) with fixed fittings	1
1	M21, AA Model	65-7594	Chaincase (front) with fixed fittings	1
2	M20, M21, M33 (rigid and spring)	29-3319	Front and rear chaincase fixing screw washer (shakeproof)	16
2	M21, AA Model	29-3319	Front and rear chaincase fixing screw washer (shakeproof)	16
3	M20, M21, M33 (rigid and spring)	1-4606	Front and rear chaincase fixing screw	16
3	M21, AA Model	1-4606	Front and rear chaincase fixing screw	16
4	M20, M21, M33 (rigid and spring)	2-930	Chaincase oil level plug washer (fibre)	1
4	M21, AA Model	2-930	Chaincase oil level plug washer (fibre)	1
5	M20, M21, M33 (rigid and spring)	66-7517	Chaincase oil level plug	1
5	M21, AA Model	66-7517	Chaincase oil level plug	1
6	M20, M21, M33 (rigid and spring)	67-42	Chaincase inspection cap washer	1
6	M21, AA Model	67-42	Chaincase inspection cap washer	1

CLUTCH and FRONT CHAINCASE

"M" Group

Plate Ref. Number.	Models.	Part No.	Description.	Number per set.
7	M20, M21, M33 (rigid and spring)	65-3364	Chaincase inspection cap	1
7	M21, AA Model	65-3364	Chaincase inspection cap	1
8	M20, M21, M33 (rigid and spring)	66-7514	Chaincase joint washer (cork)	1
8	M21, AA Model	66-7514	Chaincase joint washer (cork)	1
—	M20, M21, M33 (rigid and spring)	29-8060	Chaincase stiffening washer	1
—	M21, AA Model	29-8060	Chaincase stiffening washer	1
9	M20, M21, M33 (rigid and spring)	2-2395	Clutch spring retaining stud nut	12
10	M20, M21, M33 (rigid and spring)	66-3800	Clutch spring	6
11	M20, M21, M33 (rigid and spring)	66-3781	Clutch spring cup	6
12	M20, M21, M33 (rigid and spring)	65-3828	Clutch actuating cap complete	1
13	M20, M21, M33 (rigid and spring)	66-3787	Mainshaft nut	1
14	M20, M21, M33 (rigid and spring)	65-3822	Mainshaft nut locking washer	1
15	M20, M21, M33 (rigid and spring)	66-3903	Clutch driving plate centre complete with studs	1
16	M20, M21, M33 (rigid and spring)	65-3858	Clutch plate ferodo insert	96
17	M20, M21, M33 (rigid and spring)	65-3857	Clutch driving plate complete with inserts	4
18	M20, M21, M33 (rigid and spring)	65-3824	Clutch driven plate	3
19	M20, M21, M33 (rigid and spring)	65-3911	Clutch ball race ring (inner)	1
20	M20, M21, M33 (rigid and spring)	65-3910	Clutch ball race retaining ring	2
21	M20, M21, M33 (rigid and spring)	65-3912	Clutch ball race ring	1
22	M20, M21, M33 (rigid and spring)	66-3891	Clutch chainwheel ferodo insert	24
23	M20, M21, M33 (rigid and spring)	66-3908	Clutch chainwheel complete...	1
24	M20 (rigid and spring) (solo)	24-8931	Transmission chain (front)	1
24	M33 (rigid and spring) (solo)	24-8932	Transmission chain (front)	1
24	M20, M21 (rigid and spring)	24-8930	Transmission chain (front)	1
24	M21 (rigid)	24-8930	Transmission chain (front)	1
24	M33 (rigid and spring) (sidecar)	24-8931	Transmission chain (front)	1
25	M20, M21, M33 (rigid and spring)	65-3872	Clutch sleeve plate	1
26	M20, M21, M33 (rigid and spring)	65-3873	Clutch sleeve	1
27	M20, M21, M33 (rigid and spring)	65-3833	Clutch sleeve collar	1
28	M20, M21, M33 (rigid and spring)	66-3090	Gearbox and chaincase oil retaining washer	1
29	M20, M21, M33 (rigid and spring)	24-4232	Gearbox felt washer	1
29	M21, AA Model	24-4232	Gearbox felt washer	1
30	M20, M21, M33 (rigid)	66-7601	Chaincase (rear) with fixed fittings and sliding plate	1
30	M21, AA Model	66-7601	Chaincase (rear) with fixed fittings and sliding plate	1
30	M20, M21, M33 (spring)	65-7587	Chaincase (rear) with fixed fittings and sliding plate	1
31	M20, M21, M33 (rigid and spring)	66-7575	Chaincase and crankcase joint washer (Hallite)	1
31	M21, AA Model	66-7575	Chaincase and crankcase joint washer (Hallite)	1
32	M20, M21, M33 (rigid and spring)	24-8784	Chaincase securing bolt washer (spring)	3
32	M21, AA Model	24-8784	Chaincase securing bolt washer (spring)	3
33	M20, M21, M33 (rigid and spring)	65-7550	Chaincase securing bolt	3

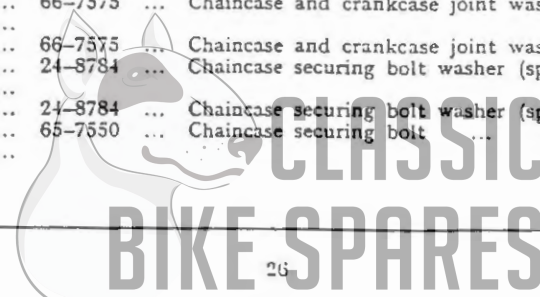



CLUTCH and FRONT CHAINCASE  
"M" Group

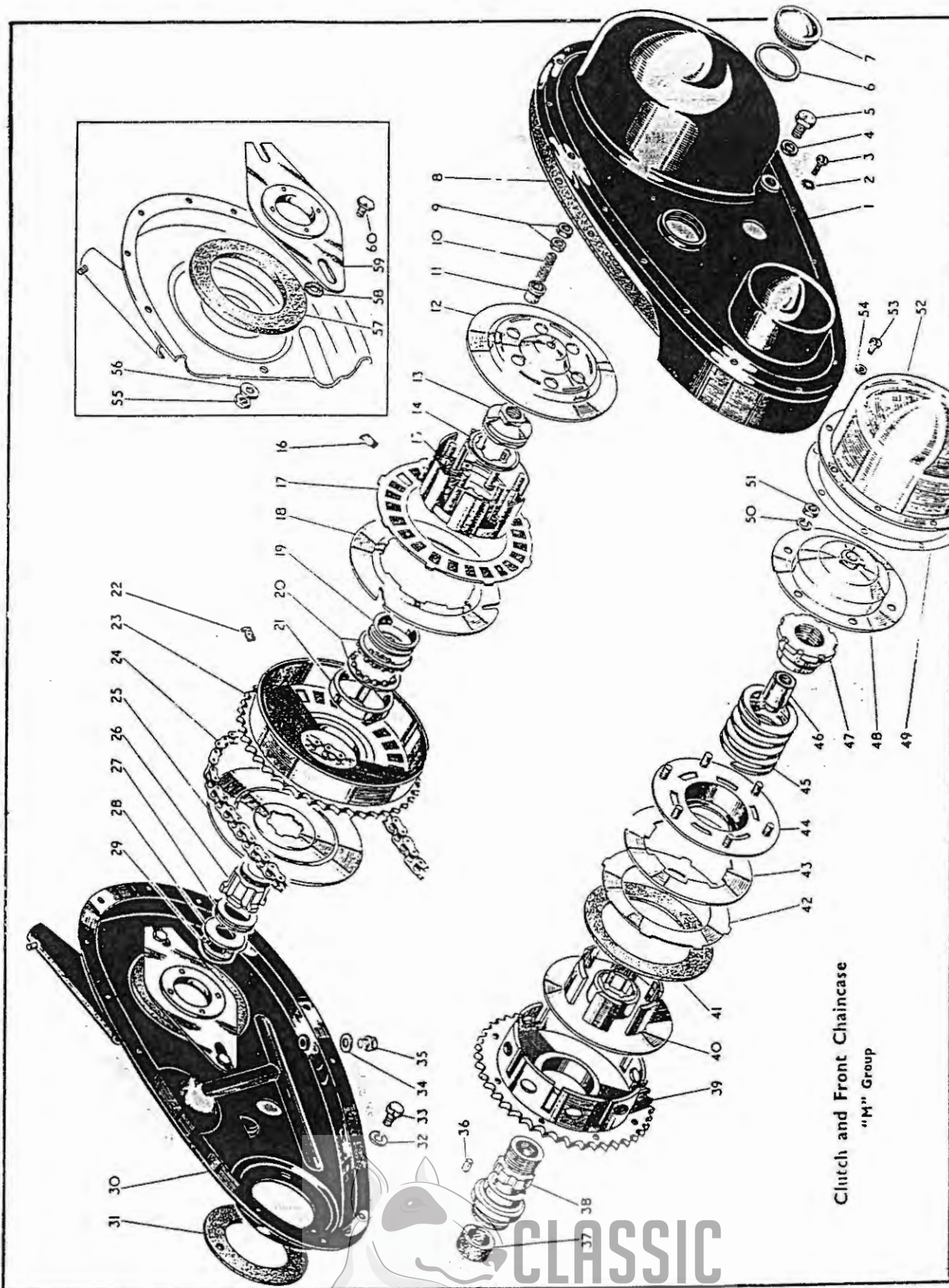

Frame and Fittings

Front Fork and Fittings

Front Hub and Wheel Fittings

Rear Hub and Wheel Fittings

Mudguards Oil Tank Toolbox and Chainguards

Petrol Tank Handlebar Dual Seat Battery Carrier and Silencer

Rear Mudguard Toolbox Chainguards Rear Brake Control and Silencer

Special Components as supplied to Automobile Association

Legshields

Tools and Sundries

Electrical Equipment

Front and Rear Safety Bars Safety Bars and Legshield

Sidecar Chassis

Carrier Pannier

CLASSIC  
BIKE SPARES

## Plate 6—continued

## CLUTCH and FRONT CHAINCASE

"M" Group

Plate Ref. Number.	Models.	Part No.	Description.	Number per set.
33	M21, AA Model	65-7550	Chaincase securing bolt	3
34	M20, M21, M33 (rigid and spring)	66-7518	Chaincase oil drain plug washer	1
34	M21, AA Model	66-7518	Chaincase oil drain plug washer	1
35	M20, M21, M33 (rigid and spring)	15-645	Chaincase oil drain plug	1
35	M21, AA Model	15-645	Chaincase oil drain plug	1
36	M21, AA Model	26-650	Clutch chainwheel roller	22
37	M21, AA Model	66-3813	Clutch sleeve cork ring	1
38	M21, AA Model	66-3811	Clutch sleeve	1
39	M21, AA Model	66-3809	Clutch chainwheel complete...	1
40	M21, AA Model	15-4306	Clutch centre	1
41	M21, AA Model	15-2419	Clutch ferodo ring	8
42	M21, AA Model	66-3812	Clutch driving plate	4
43	M21, AA Model	15-4307	Clutch driven plate	3
43	M20, M21, M33 (rigid and spring)	29-3832	Clutch driven plate (plain)	1
44	M21, AA Model	15-4308	Clutch sliding plate complete	1
45	M21, AA Model	15-4311	Clutch spring	1
46	M21, AA Model	15-374	Mainshaft nut	1
47	M21, AA Model	15-4312	Clutch spring nut	1
48	M21, AA Model	15-4313	Clutch operating cap complete	1
49	M21, AA Model	15-4316	Clutch cover washer (paper)	1
50	M21, AA Model	2-1462	Clutch sliding plate washer (spring)	6
51	M21, AA Model	2-51	Clutch sliding plate nut	6
52	M21, AA Model	15-4315	Clutch cover	1
53	M21, AA Model	2-360	Clutch cover fixing screw	8
54	M21, AA Model	24-7068	Clutch cover fixing screw washer	8
55	M20, M21, M33 (rigid and spring)	2-443	Chaincase sliding plate bolt nut	2
55	M21, AA Model	2-443	Chaincase sliding plate bolt nut	2
56	M20, M21, M33 (rigid and spring)	2-1374	Chaincase sliding plate bolt washer (plain)	2
56	M21, AA Model	2-1374	Chaincase sliding plate bolt washer (plain)	2
57	M20, M21, M33 (rigid and spring)	15-8814	Chaincase back felt washer	1
57	M21, AA Model	15-8814	Chaincase back felt washer	1
58	M20, M21, M33 (rigid and spring)	66-7518	Chaincase sliding plate bolt washer (fibre)	2
58	M21, AA Model	66-7518	Chaincase sliding plate bolt washer (fibre)	2
59	M20, M21, M33 (rigid and spring)	66-7520	Chaincase sliding plate complete	1
59	M21, AA Model	66-7520	Chaincase sliding plate complete	1
60	M20, M21, M33 (rigid and spring)	66-7523	Chaincase sliding plate bolt...	2
60	M21, AA Model	66-7523	Chaincase sliding plate bolt...	2

## Plate 7

## FRAME and FITTINGS

"M" Group (Rigid and Spring Frame)

Plate Ref. Number.	Model.	Part No.	Description.	Number per set.
1	M20, M21, M33 (rigid and spring)	29-7551	Footrest rubber	2
2	M20, M21, M33 (rigid and spring)	65-4891	Footrest bracket (offside)	1
3	M20, M21, M33 (rigid and spring)	15-5753	Footrest rod nut	2
4	M20, M21, M33 (rigid and spring)	65-695	Footrest and washer (shakeproof)	2
5	M20, M21, M33 (rigid and spring)	24-5914	Footrest rod washer (plain)	2
6	M20, M21, M33 (rigid and spring)	66-2725	Front engine plate and chainstay bolt nut (when crankcase shield fitted)	1
6	M20, M21, M33 (rigid and spring)	2-1925	Front engine plate and chainstay bolt nut	2

CLASSIC  
BIKE SPARES



FRAME and FITTINGS  
 "M" Group (Rigid and Spring Frame)

Plate Ref. Number.	Models.	Part No	Description.	Number per set.	
7	M20, M21, M33 (rigid and spring)	31-4070	Front engine plate and chainstay bolt washer	1	
8	M20, M21, M33 (rigid and spring)	66-4183	Front engine plate and chainstay distance piece	1	
9	M20, M21, M33 (rigid and spring)	66-4098	Engine yoke plate bolt (top)	1	
10	M20, M21, M33 (rigid and spring)	66-4181	Engine plate cover (front)	1	
11	M20, M21, M33 (rigid and spring)	29-3319	Engine plate front cover fixing screw washer (shakeproof)	4	
12	M20, M21, M33 (rigid and spring)	24-7065	Engine plate front cover fixing screw	4	Frame and Fittings
13	M20, M21, M33 (rigid and spring)	66-4149	Ball head cup	2	
14	M20, M21, M33 (rigid and spring)	1-4675	Ball head cup ball (steel)	40	Front Fork and Fittings
15	M20, M21, M33 (rigid and spring)	66-4176	Frame front complete (1954)	1	
16	M20, M21, M33 (rigid and spring)	28-2080	Ball head grease nipple	1	
17	M20, M21 (rigid and spring)	65-9195	Air cleaner (up to 1954)	1	Front Hub and Wheel Fittings
18	M20, M21 (rigid and spring)	65-1210	Air cleaner adaptor (up to 1954)	1	
19	M20, M21, M33 (rigid and spring)	2-995	Backstay and seat lug stud washer (double spring)	2	
20	M20, M21, M33 (rigid and spring)	2-46	Backstay and seat lug stud nut	2	Rear Hub and Wheel Fittings
21	M20, M21, M33 (rigid and spring)	2-1925	Front down tube and engine plate stud nut	1	
22	M20, M21, M33 (rigid and spring)	66-4708	Front down tube and engine plate stud washer (shakeproof)	1	
23	M20, M21, M33 (rigid and spring)	27-5694	Front down tube and engine plate stud	1	Mudguards Oil Tank Toolbox and Chainguards
24	M20, M21, M33 (rigid and spring)	2-2138	Engine yoke plate and frame stud washer	2	
25	M20, M21, M33 (rigid and spring)	27-5684	Engine yoke plate and frame stud	5	
26	M20, M21, M33 (rigid and spring)	66-4180	Engine plate (front)	2	Petrol Tank Handlebar Dual Seat Battery Carrier and Silencer
27	M20, M21, M33 (rigid and spring)	27-5683	Engine yoke plate and frame stud (front)	1	
28	M20, M21, M33 (rigid and spring)	66-4173	Front engine plate and chainstay bolt (when crankcase shield fitted)	1	Rear Mudguard Toolbox Chainguards Rear Brake Control and Silencer
—	M20, M21, M33 (rigid and spring)	3-1190	Front engine plate and chainstay bolt	1	
29	M20, M21, M33 (rigid and spring)	66-4707	Engine yoke plate and frame stud washer (shakeproof)	13	
30	M20, M21, M33 (rigid and spring)	2-46	Engine yoke plate and frame stud nut	13	Special Components as supplied to Automobile Association
31	M20, M21, M33 (rigid and spring)	65-4811	Footrest rod distance tube	2	
32	M20, M21, M33 (rigid)	66-4531	Chainstay bridge distance piece (front)	1	
33	M20, M21, M33 (rigid and spring)	66-4903	Chaincase distance sleeve	2	Legshields
34	M20, M21, M33 (rigid and spring)	66-4900	Footrest rod	1	
35	M20, M21, M33 (rigid and spring)	66-4902	Footrest cork washer	2	
36	M20, M21, M33 (rigid and spring)	65-4890	Footrest bracket (nearside)	1	Tools and Sundries
37	M21, AA Model	66-7010	Rear brake pedal complete	1	
37	M20, M21, M33 (rigid)	66-7005	Rear brake pedal complete	1	
37A	M20, M21, M33 (rigid and spring)	66-4207	Locating tube (seat lug and stays)	1	Electrical Equipment
38	M20, M21, M33 (rigid and spring)	66-2810	Saddle front connecting bolt nut	1	
39	M20, M21, M33 (rigid and spring)	35-698	Saddle front connecting bolt split pin	1	Front and Rear Safety Bars Safety Bars and Legshields
39A	M20, M21, M33 (rigid and spring)	66-4234	Frame complete with chainstay, backstay, central stand and engine plates	1	

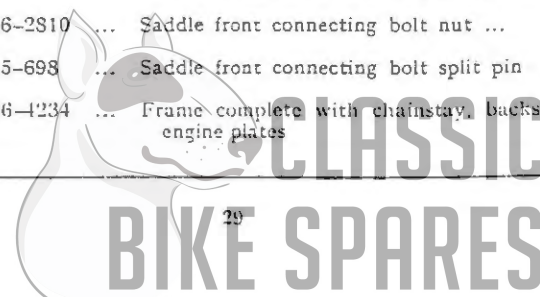

Frame and Fittings

Front Fork and Fittings

Front Hub and Wheel Fittings

Rear Hub and Wheel Fittings

Mudguards Oil Tank Toolbox and Chainguards

Petrol Tank Handlebar Dual Seat Battery Carrier and Silencer

Rear Mudguard Toolbox Chainguards Rear Brake Control and Silencer

Special Components as supplied to Automobile Association

Legshields

Tools and Sundries

Electrical Equipment

Front and Rear Safety Bars Safety Bars and Legshields

Sidecar Chassis

Carrier and Pannier

## FRAME and FITTINGS

"M" Group (Rigid and Spring Frame)

Plate Ref. Number.	Models.	Part No.	Description.	Number per set.
—	M20, M21, M33 (rigid)	66-4233	Frame complete with chainstay, and backstay	1
40	M20, M21, M33 (rigid and spring)	33-4089	Saddle front connecting bolt	1
41	M20, M21, M33 (rigid and spring)	2S-2080	Saddle front connecting bolt grease nipple	1
42	M20, M21, M33 (rigid and spring)	66-4206	Backstay and seat lug stud	1
43	M20, M21, M33 (rigid)	2-2395	Carrier fixing screw nut	4
44	M20, M21, M33 (rigid)	2-1462	Carrier fixing screw washer (spring)	4
45	M20, M21, M33 (rigid)	66-6979	Carrier complete	1
46	M20, M21, M33 (rigid)	2-1374	Carrier fixing screw washer (plain)	4
47	M20, M21, M33 (rigid)	2-1354	Carrier fixing screw	4
48	M20, M21, M33 (rigid)	2-49	Saddle rear spring stud nut	2
49	M20, M21, M33 (rigid)	66-4647	Saddle rear spring stud	2
50	M20, M21, M33 (rigid)	2-49	Saddle rear spring stud nut	2
51	M20, M21, M33 (rigid)	36-382	Saddle rear spring stud washer (shakeproof)	2
52	M20, M21, M33 (rigid)	30-660	Rear brake pedal fulcrum pin washer (plain)	1
53	M20, M21, M33 (rigid)	66-4708	Rear brake pedal fulcrum pin washer (shakeproof)	1
54	M20, M21, M33 (rigid)	15-541	Rear brake pedal fulcrum pin nut	1
55	M20, M21, M33 (rigid)	15-8155	Pillion footrest spindle rubber	2
56	M20, M21, M33 (rigid)	66-4936	Pillion footrest spindle complete (nearside)	1
57	M20, M21, M33 (rigid)	2-1946	Sidecar chainstay lug stud nut	1
58	M20, M21, M33 (rigid)	35-722	Sidecar chainstay lug stud split pin	2
59	M20, M21, M33 (rigid)	33-4160	Sidecar chainstay lug stud	1
60	M20, M21, M33 (rigid and spring)	65-4784	Prop stand clip bolt	2
—	M20, M21, M33 (rigid and spring)	2-49	Prop stand bolt nut	2
61	M20, M21, M33 (rigid)	2-861	Rear brake pedal stop plate washer	1
62	M20, M21, M33 (rigid)	27-6312	Pillion footrest spindle bolt	2
63	M20, M21, M33 (rigid and spring)	36-382	Prop stand clip bolt washer	2
64	M20, M21, M33 (rigid)	27-4401	Rear chain adjuster screw locknut	1
65	M20, M21, M33 (rigid)	66-4620	Rear chain adjuster screw	1
66	M20, M21, M33 (rigid)	66-7034	Rear brake pedal bush	1
67	M20, M21, M33 (rigid and spring)	2-923	Saddle rear spring stud washer	4
68	M20, M21, M33 (rigid and spring)	2-49	Saddle rear spring stud nut	2
69	M20, M21, M33 (rigid)	15-4100	Rear brake pedal fulcrum pin washer (thin)	1
70	M20, M21, M33 (rigid)	2S-2080	Rear brake pedal grease nipple	1
71	M20, M21, M33 (rigid)	2-79	Rear brake retaining spring bolt	1
72	M20, M21, M33 (rigid)	29-541	Rear brake retaining spring bolt washer (shakeproof)	1
73	M20, M21, M33 (rigid)	2-1027	Rear brake retaining spring bolt nut	1

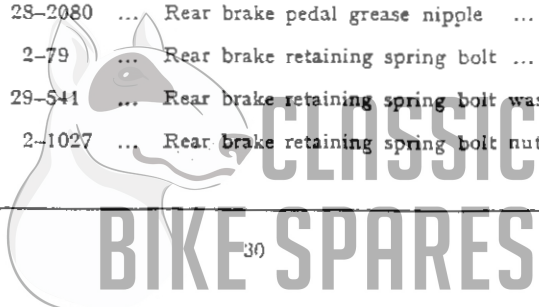



FRAME and FITTINGS  
 "M" Group (Rigid and Spring Frame)

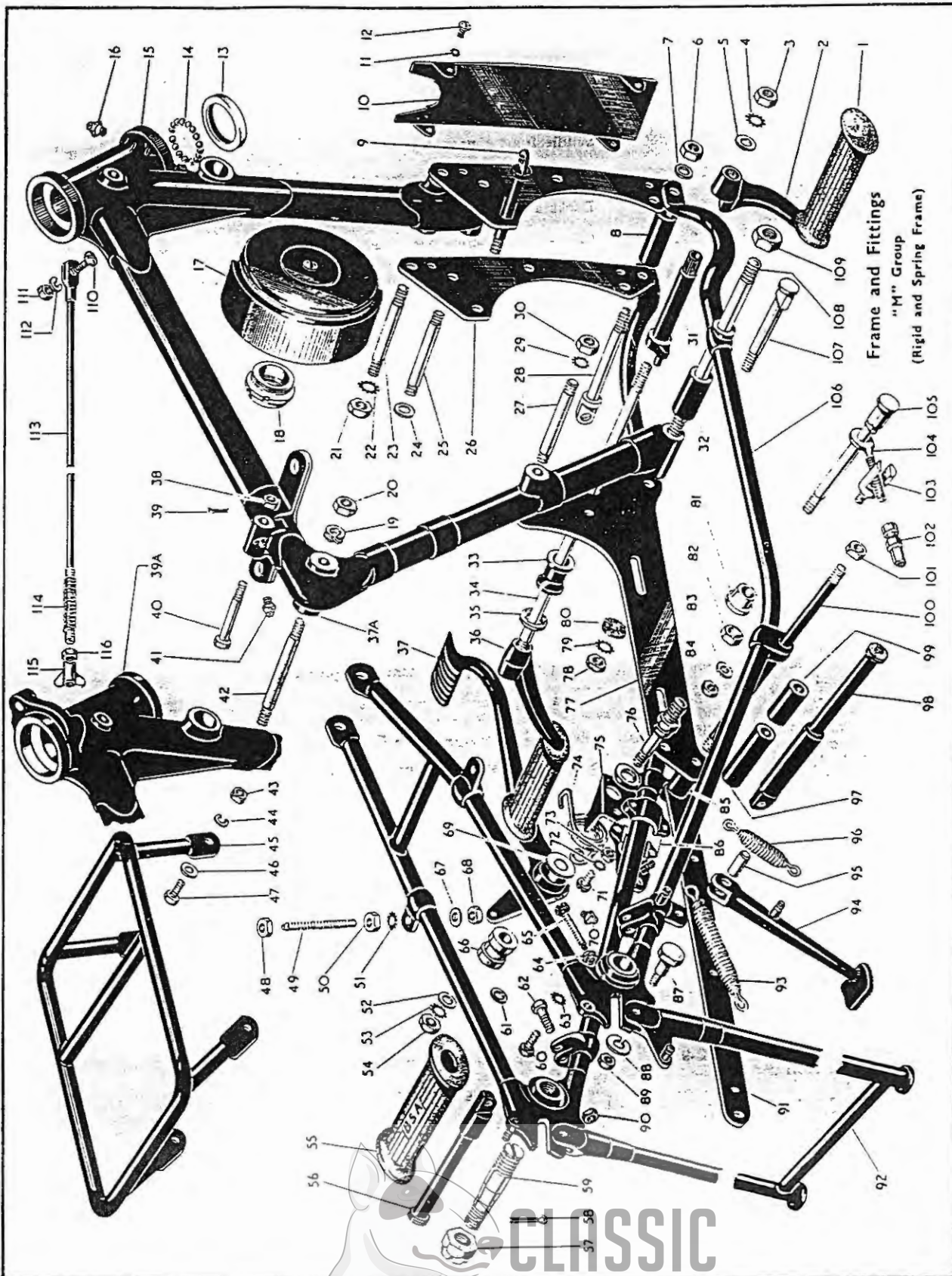

Frame and Fittings  
 "M" Group  
 (Rigid and Spring Frame)

Front Fork and Fittings

Front Hub and Wheel Fittings

Rear Hub and Wheel Fittings

Mudguards  
 Oil Tank  
 Toolbox and Chainguards

Petrol Tank  
 Handlebar  
 Dual Seat  
 Battery Carrier and Silencer

Rear Mudguard  
 Toolbox  
 Chainguards  
 Rear Brake  
 Control and Silencer

Special Components as supplied to Automobile Association

Legshields

Tools and Sundries

Electrical Equipment

Front and Rear Safety Bars  
 Safety Bars and Legshield

Sidecar Chassis

Carrier and Pannier

CLASSIC  
 BIKE SPARES

FRAME and FITTINGS  
"M" Group (Rigid and Spring Frame)

Plate Ref. Number.	Models.	Part No.	Description.	Number per set.
74	M20, M21, M33 (rigid)	66-7032	Rear brake pedal return spring	1
75	M20, M21, M33 (rigid)	66-7033	Rear brake pedal stop plate	1
76	M20, M21, M33 (rigid)	66-7029	Rear brake pedal fulcrum pin	1
77	M20, M21, M33 (rigid)	66-4157	Engine plate (rear)	2
78	M20, M21, M33 (rigid and spring)	2-46	Gearbox connecting bolt nut	1
79	M20, M21, M33 (rigid and spring)	66-4707	Gearbox connecting bolt washer (shakeproof)	2
80	M20, M21, M33 (rigid and spring)	65-4189	Gearbox connecting bolt washer (serrated)	2
81	M20, M21, M33 (rigid and spring)	66-4169	Gearbox connecting bolt collar	1
82	M20, M21, M33 (rigid)	15-1455	Rear brake pedal fulcrum pin locknut	1
83	M20, M21, M33 (rigid and spring)	2-923	Gearbox adjuster stop washer	1
84	M20, M21, M33 (rigid and spring)	2-49	Gearbox adjuster stop nut	1
85	M20, M21, M33 (rigid)	66-4602	Chainstay bridge distance collar (left-hand)	1
86	M20, M21, M33 (rigid)	65-4739	Prop stand lug complete	1
87	M20, M21, M33 (rigid)	24-6055	Rear stand bolt	2
88	M20, M21, M33 (rigid)	15-716	Rear stand bolt washer (spring)	2
89	M20, M21, M33 (rigid)	24-6040	Rear stand bolt nut	2
90	M20, M21, M33 (rigid)	2-49	Pillion footrest spindle bolt nut	2
91	M20, M21 (rigid)	15-5816	Rear brake anchor strap	1
92	M20, M21, M33 (rigid)	66-4772	Rear stand complete	1
93	M20, M21, M33 (rigid)	66-4767	Rear stand spring	1
94	M20, M21, M33 (rigid and spring)	65-4735	Prop stand	1
—	M20, M21, M33 (spring)	65-4745	Prop stand assembly	1
—	M20, M21, M33 (rigid)	65-4734	Prop stand assembly	1
95	M20, M21, M33 (rigid and spring)	65-4741	Prop stand pivot pin	1
96	M20, M21, M33 (rigid and spring)	65-4742	Prop stand spring	1
97	M20, M21, M33 (rigid)	15-6240	Chainstay bridge distance collar (centre)	1
98	M20, M21, M33 (rigid)	66-4936	Pillion footrest spindle complete (offside)	1
99	M20, M21, M33 (rigid)	66-4601	Chainstay bridge distance collar (right-hand)	1
100	M20, M21, M33 (rigid)	15-6325	Chainstay bridge connecting stud	1
101	M20, M21, M33 (rigid and spring)	2-46	Chainstay bridge connecting stud nut	2
102	M20, M21, M33 (rigid and spring)	15-5664	Gearbox adjuster nut	1
103	M20, M21, M33 (rigid and spring)	66-4167	Gearbox adjuster stop	1
104	M20, M21, M33 (rigid and spring)	27-5710	Gearbox adjuster bolt	1
105	M20, M21, M33 (rigid and spring)	66-4168	Gearbox connecting bolt (rear)	1
106	M20, M21, M33 (rigid)	66-4618	Chainstay and backstay complete	1
107	M20, M21, M33 (rigid and spring)	15-476	Gearbox connecting bolt (front)	1
108	M20, M21, M33 (rigid and spring)	66-4604	Chainstay and seat tube connecting stud	1





Plate 7—continued

FRAME and FITTINGS  
"M" Group (Rigid and Spring Frame)

Plate Ref. Number.	Model.	Part No.	Description.	Number per set.
109	M20, M21, M33 (rigid)	2-52	Chainstay to seat tube connecting stud nut	2
109	M20, M21, M33 (rigid and spring)	66-2726	Chainstay and seat tube connecting stud nut (when crankcase shield fitted)	2
110	M20, M21, M33 (rigid)	2-510	Rear brake rod toggle end pin	1
111	M20, M21, M33 (rigid)	2-443	Rear brake rod toggle end nut	1
112	M20, M21, M33 (rigid)	2-1462	Rear brake rod toggle end washer (spring)	1
113	M20, M21, M33 (rigid)	65-7007	Rear brake rod	1
114	M20, M21, M33 (rigid)	15-7980	Rear brake rod spring	1
115	M20, M21, M33 (rigid)	15-7985	Rear brake rod flynut	1
116	M20, M21, M33 (rigid)	2-2395	Rear brake rod locknut	1

Front Fork and Fittings

Front Hub and Wheel Fittings

Plate 8

FRAME and FITTINGS  
"M" Group (Rear Suspension).

Plate Ref. Number.	Model.	Part No.	Description.	Number per set.
1	M20, M21, M33 (spring)	29-4880	Central stand complete	1
2	M20, M21, M33 (spring)	65-4727	Central stand spring	1
3	M20, M21, M33 (spring)	29-4840	Central stand engine plate distance piece	1
4	M20, M21, M33 (spring)	27-5694	Central stand stud	1
5	M20, M21, M33 (spring)	2-1967	Central stand stud washer (spring)	2
6	M20, M21, M33 (spring)	2-1925	Central stand stud nut	2
7	M20, M21, M33 (spring)	35-5016	Central stand grease nipple	1
8	M20, M21, M33 (spring)	66-4190	Chainstay and backstay complete	1
9	M20, M21, M33 (spring)	66-4581	Chainstay distance piece (front)	1
10	M20, M21, M33 (spring)	66-4200	Gearbox engine plate (offside)	1
11	M20, M21, M33 (spring)	66-4201	Gearbox engine plate (nearside)	1
12	M20, M21, M33 (spring)	65-7060	Rear brake pedal complete	1
12A	M20, M21, M33 (spring)	65-7080	Rear brake pedal stop	1
13	M20, M21, M33 (spring)	30-196	Rear brake pedal washer (plain)	1
—	M20, M21, M33 (rigid and spring)	67-4032	Rear brake pedal stud	1
—	M20, M21, M33 (rigid and spring)	2-46	Rear brake pedal stud nut	1
14	M20, M21, M33 (spring)	2-522	Rear brake pedal washer (spring)	1
15	M33 (rigid and spring)	65-9198	Air cleaner elbow (up to 1954)	1
16	M33 (rigid and spring)	2-14	Air cleaner elbow screw (up to 1954)	1
17	M33 (rigid and spring)	65-9196	Air cleaner (up to 1954)	1
17	M20, M21 (spring)	66-9255	Air cleaner	1
17	M21 (rigid)	66-9255	Air cleaner	1

Rear Hub and Wheel Fittings

Mudguards Oil Tank Toolbox and Chainguards

Petrol Tank Handlebar Dual Seat Battery Carrier and Silencer

Rear Mudguard Toolbox Chainguards Rear Brake Control and Silencer

Special Components as supplied to Automobile Association

Legshields

Tools and Sundries

Electrical Equipment

Front and Rear Safety Bars Safety Bars and Legshield:

Sidcar Chassis

Carrier and Pannier



## FRAME and FITTINGS

"M" Group (Rear Suspension)

Plate Ref. Number.	Models.	Part No.	Description.	Number per set.
17	... M33 (rigid and spring) M20 (rigid)	... 65-9271	... Air cleaner	... 1
—	... M33 (rigid and spring) M20 (rigid)	... 19-5203	... Air cleaner element	... 1
—	... M20, M21 (spring) M21 (rigid)	... 19-5202	... Air cleaner element	... 1
—	... M20, M21, M33 (rigid and spring)	... 19-5206	... Air filter felt ring	... 2
18	... M33 (rigid and spring)	... 65-1237	... Air cleaner adaptor (up to 1954)	... 1
19	... M33 (rigid and spring)	... 29-541	... Air cleaner elbow screw washer (shakeproof) (up to 1954)	... 1
20	... M20, M21, M33 (spring)	... 15-7161	... Carrier fixing screw	... 4
21	... M20, M21, M33 (spring)	... 67-6921	... Carrier complete	... 1
22	... M20, M21, M33 (spring)	... 2-1462	... Carrier fixing screw washer (spring)	... 4
23	... M20, M21, M33 (spring)	... 2-2395	... Carrier fixing screw nut	... 4
24	... M20, M21, M33 (spring)	... 2-49	... Saddle rear fixing stud nut	... 4
25	... M20, M21, M33 (spring)	... 2-923	... Saddle rear fixing stud washer	... 4
26	... M20, M21, M33 (spring)	... 67-4040	... Saddle rear fixing stud	... 2
27	... M20, M21, M33 (spring)	... 66-4205	... Lifting handle	... 1
28	... M20, M21, M33 (spring)	... 31-68	... Plunger carrier column bolt top	... 2
29	... M20, M21, M33 (spring)	... 67-4132	... Plunger spring (top)	... 2
30	... M20, M21, M33 (spring)	... 89-4257	... Plunger spring top collar	... 2
31	... M20, M21, M33 (spring)	... 89-4249	... Plunger spring inner shroud	... 2
32	... M20, M21, M33 (spring)	... 89-4248	... Plunger spring outer shroud	... 2
33	... M20, M21, M33 (spring)	... 67-4134	... Plunger carrier column assembly	... 2
34	... M20, M21, M33 (spring)	... 67-4166	... Plunger carrier column screwed plug	... 2
35	... M20, M21, M33 (spring)	... 3-1399	... Clamp lug bolt	... 2
36	... M20, M21, M33 (spring)	... 89-4046	... Plunger complete	... 2
37	... M20, M21, M33 (spring)	... 67-4125	... Rear spindle clamp lug (nearside)	... 1
38	... M20, M21, M33 (spring)	... 66-4707	... Clamp lug bolt washer (shakeproof)	... 2
39	... M20, M21, M33 (spring)	... 15-1312	... Rear wheel adjusting screw spring	... 2
40	... M20, M21, M33 (spring)	... 67-4127	... Rebound spring top collar	... 2
41	... M20, M21, M33 (spring)	... 35-722	... Sidecar chainstay lug stud split pin	... 2
42	... M20, M21, M33 (spring)	... 67-4182	... Sidecar chainstay lug stud locknut	... 1
43	... M20, M21, M33 (spring)	... 67-4181	... Sidecar chainstay lug stud	... 1
44	... M20, M21, M33 (spring)	... 2-1946	... Sidecar chainstay lug stud nut	... 1
45	... M20, M21, M33 (spring)	... 66-4603	... Rear wheel adjusting screw...	... 2
46	... M20, M21, M33 (spring)	... 2-46	... Clamp lug bolt nut	... 2
47	... M20, M21, M33 (spring)	... 67-4126	... Rear spindle clamp lug (offside)	... 1





FRAME and FITTINGS  
"M" Group (Rear Suspension)

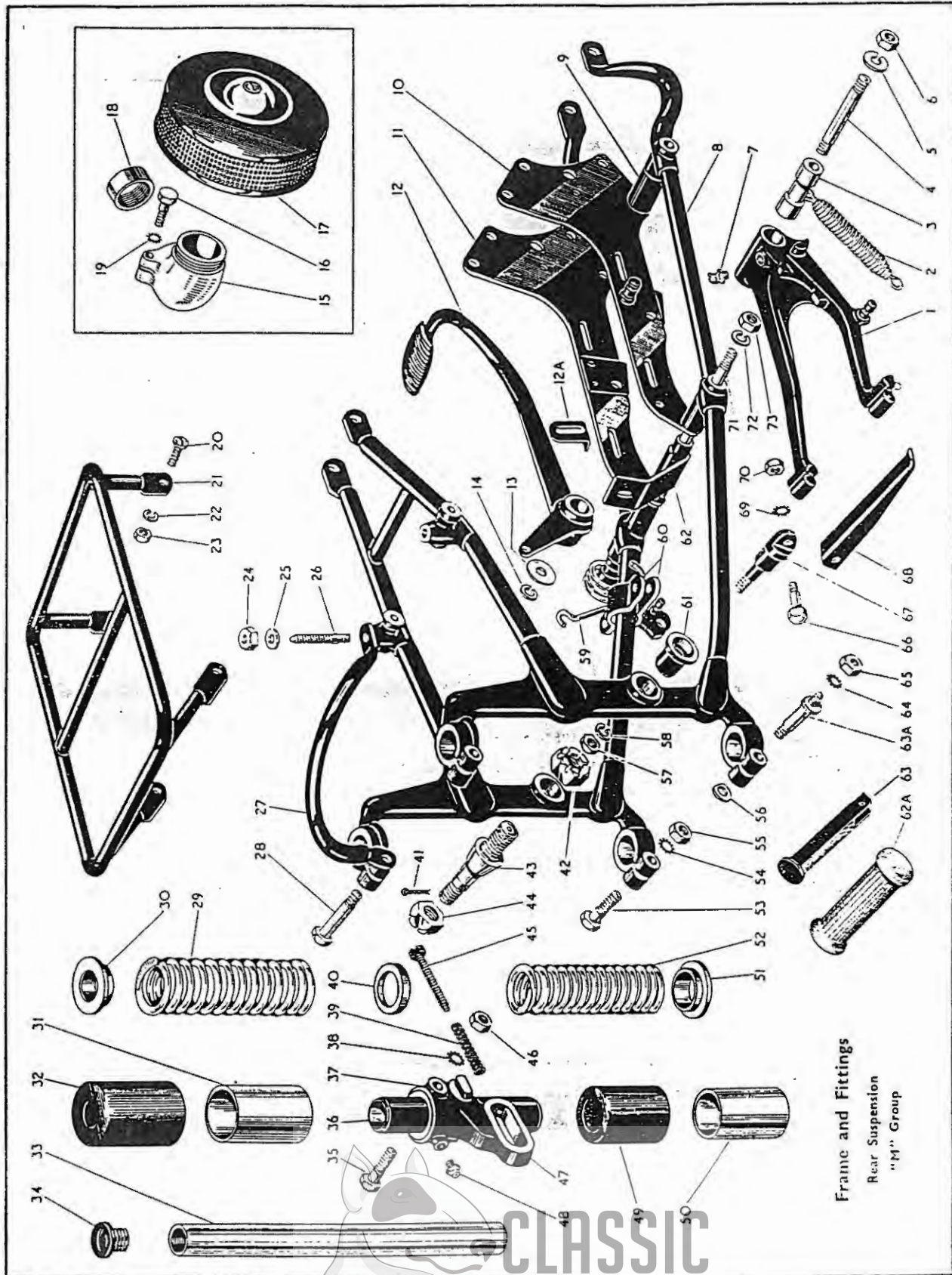

Frame and Fittings  
Rear Suspension  
"M" Group

Front Fork  
and  
Fittings

Front Hub  
and Wheel  
Fittings

Rear Hub  
and Wheel  
Fittings

Mudguards  
Oil Tank  
Toolbox and  
Chainguards

Petrol Tank  
Handlebar  
Dual Seat  
Battery Carrier  
and Silencer

Rear Mudguard  
Toolbox  
Chainguards  
Rear Brake  
Control  
and Silencer

Special  
Components  
as supplied to  
Automobile  
Association

Legshields

Tools and  
Sundries

Electrical  
Equipment

Front and Rear  
Safety Bars  
Safety Bars  
and Legshield

Sidocar  
Chassis

Carrier  
Pannier

CLASSIC  
BIKE SPARES

## FRAME and FITTINGS

"M" Group (Rear Suspension).

Plate Ref. Number.	Models.	Part No.	Description.	Number per set.
48	M20, M21, M33 (spring)	28-2080	Clamp lug grease nipple	2
49	M20, M21, M33 (spring)	89-4240	Rebound spring outer shroud	2
50	M20, M21, M33 (spring)	89-4241	Rebound spring inner shroud	2
51	M20, M21, M33 (spring)	89-4258	Rebound spring bottom collar	2
52	M20, M21, M33 (spring)	89-4259	Rebound spring (bottom)	2
53	M20, M21, M33 (spring)	3-1399	Plunger carrier bottom clip bolt (nearside)	1
54	M20, M21, M33 (spring)	66-4707	Plunger carrier column bolt washer (shakeproof)	4
55	M20, M21, M33 (spring)	2-46	Plunger carrier column bolt nut	4
56	M20, M21, M33 (spring)	67-4129	Plunger carrier bottom clip bolt distance washer	2
57	M20, M21, M33 (spring)	2-46	Pillion footrest anchor bolt nut	2
58	M20, M21, M33 (spring)	2-2903	Pillion footrest anchor bolt washer (spring)	2
59	M20, M21, M33 (spring)	65-7063	Rear brake pedal return spring	1
60	M20, M21, M33 (spring)	65-4743	Prop stand lug complete	1
61	M20, M21, M33 (spring)	67-4183	Pillion footrest adaptor	2
62	M20, M21, M33 (spring)	66-6851	Rear mudguard front fixing bracket complete	1
62A	M20, M21, M33 (spring)	29-7583	Pillion footrest rubber	2
63	M20, M21, M33 (spring)	29-7581	Pillion footrest	2
63A	M20, M21, M33 (spring)	67-4128	Plunger carrier bottom clip bolt and silencer support	1
64	M20, M21, M33 (spring)	36-382	Plunger carrier bottom clip bolt and silencer support washer (shakeproof)	1
65	M20, M21, M33 (spring)	2-49	Plunger carrier bottom clip and silencer support nut	1
66	M20, M21, M33 (spring)	29-7564	Pillion footrest swivel bolt	2
67	M20, M21, M33 (spring)	29-7560	Pillion footrest anchor bolt	2
68	M20, M21, M33 (spring)	*29-7561	Pillion footrest with stiffening piece	2
69	M20, M21, M33 (spring)	36-382	Pillion footrest swivel bolt washer (shakeproof)	2
70	M20, M21, M33 (spring)	24-6040	Pillion footrest swivel bolt nut	2
71	M20, M21, M33 (spring)	66-4198	Chainstay bridge connecting stud	1
72	M20, M21, M33 (spring)	2-522	Chainstay bridge connecting stud washer (spring)	2
73	M20, M21, M33 (spring)	2-46	Chainstay bridge connecting stud nut	2
—	M20, M21, M33 (spring)	30 650	Pillion footrest anchor bolt washer (plain)	2



\*Superseded by 29-7581 pillion footrest.

CLASSIC  
BIKE SPARES



FRONT FORK and FITTINGS  
"M" Group

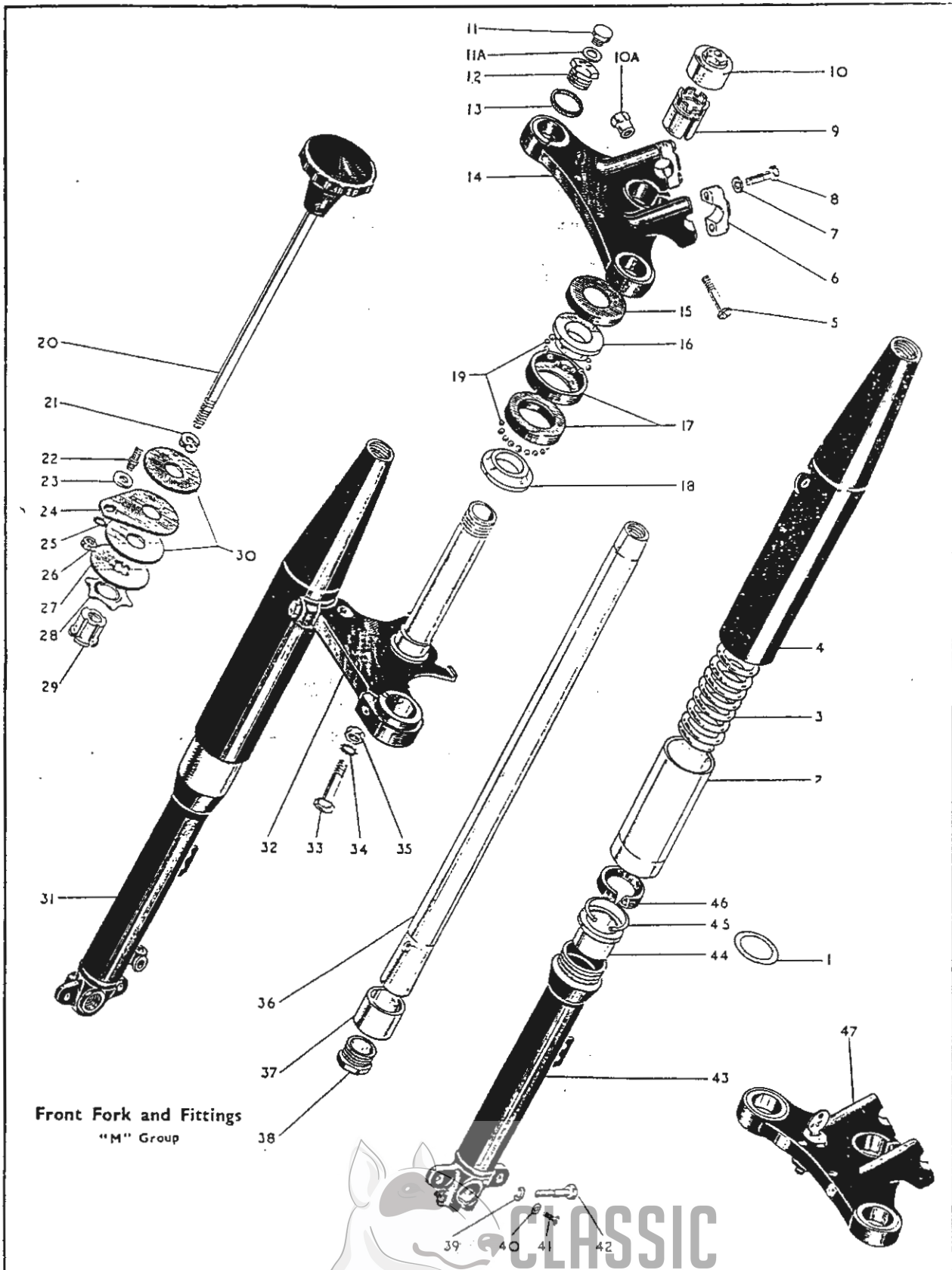

Front Fork and Fittings  
"M" Group

Front Fork and Fittings

Front Hub and Wheel Fittings

Rear Hub and Wheel Fittings

Mudguards Oil Tank Toolbox and Chainguards

Petrol Tank Handlebar Dual Seat Battery Carrier and Silencer

Rear Mudguards Toolbox Chainguards Rear Brake Control and Silencer

Special Components as supplied to Automobile Association

Legshields

Tools and Sundries

Electrical Equipment

Front and Rear Safety Bars Safety Bar and Legshield

Sidcar Chassis

Carrier Panniers

Plate Ref. Number.	Model.	Part No.	Description.	Number per set.
—	M20, M21, M33 (rigid and spring)	65-5400	Front fork assembled (7" brake) (1952)	1
—	M20, M21, M33 (rigid and spring)	65-5443	Front fork assembled (7" brake) (1951/5)	1
—	M20, M21, M33 (rigid and spring)	65-5444	Front fork assembled (8" brake)	1
—	M20, M21, M33 (rigid and spring)	65-5433	Front fork assembled (8" brake) (1953/4)	1
—	M21 AA Model	66-5105	Front fork assembled (8" brake)	1
1	M20, M21, M33 (rigid and spring)	29-5334	Front fork top bush shim (.005")	as reqd.
		29-5335	Front fork top bush shim (.010")	as reqd.
		29-5336	Front fork top bush shim (.020")	as reqd.
		29-5337	Front fork top bush shim (.030")	as reqd.
2	M20, M21, M33 (rigid and spring)	29-5310/3	Front fork oil seal holder	2
3	M20, M21, M33 (rigid and spring)	65-5390	Front fork spring (M21, M33 solo)	2
3	M20, M21, M33 (rigid and spring)	65-5391	Front fork spring (M21, M33 sidecar)	2
4	M20, M21, M33 (rigid and spring)	67-5009	Fork outer sleeve	2
4	M21 AA Model	67-5042	Fork outer sleeve with lamp bracket (nearside)	1
4	M21 AA Model	67-5044	Fork outer sleeve with lamp bracket (offside)	1
5	M20, M21, M33 (rigid and spring)	27-5135	Fork top yoke clip bolt	1
6	M20, M21, M33 (rigid and spring)	65-5333	Handlebar clip	2
7	M20, M21, M33 (rigid and spring)	15-5155	Handlebar clip bolt washer	4
8	M20, M21, M33 (rigid and spring)	65-5334	Handlebar clip bolt	4
9	M20, M21, M33 (rigid and spring)	67-5023	Steering stem adjusting sleeve	1
10	M20, M21, M33 (rigid and spring)	67-5024	Steering stem adjusting sleeve cap	1
10A	M20, M21, M33 (rigid and spring)	66-5097	Fork top yoke clip bolt nut	1
11	M21 AA Model	2-84	Fork filler plug	2
11A	M21 AA Model	2-100	Fork filler plug washer (fibre)	2
12	M20, M21, M33 (rigid and spring)	65-5331	Fork tube nut	2
12	M21 AA Model	66-5106	Fork tube nut	2
13	M20, M21, M33 (rigid and spring)	65-5332	Fork tube nut washer	2
14	M20, M21, M33 (rigid and spring)	65-5448	Front fork top yoke	1
14	M21 AA Model (rigid and spring)	65-5447	Front fork top yoke	1
15	M20, M21, M33 (rigid and spring)	66-5204	Steering head dust cap	1
16	M20, M21, M33 (rigid and spring)	65-5126	Steering head ballrace cone (top)	1
17	M20, M21, M33 (rigid and spring)	66-4149	Steering head ballrace cup	2
18	M20, M21, M33 (rigid and spring)	65-5127	Steering head ballrace cone (bottom)	1
19	M20, M21, M33 (rigid and spring)	1-4675	Steering head balls	40
20	M20, M21, M33 (rigid and spring)	67-5021	Steering damper adjusting rod	1
21	M20, M21, M33 (rigid and spring)	24-6035	Steering damper knob washer (spring)	1
22	M20, M21, M33 (rigid and spring)	65-5327	Steering damper anchor plate stud	1
23	M20, M21, M33 (rigid and spring)	2-923	Steering damper stud washer	1
24	M20, M21, M33 (rigid and spring)	27-5152	Steering damper anchor plate	1
25	M20, M21, M33 (rigid and spring)	36-382	Steering damper anchor plate washer	1



FRONT FORK and FITTINGS  
"M" Group

Plate Ref. Number.	Models.	Part No.	Description.	Number per set.
26	M20, M21, M33 (rigid and spring)	2-49	Steering damper anchor plate stud nut	1
27	M20, M21, M33 (rigid and spring)	25-5241	Steering damper bottom plate	1
28	M20, M21, M33 (rigid and spring)	25-5247	Steering damper star washer	1
29	M20, M21, M33 (rigid and spring)	65-5328	Steering damper centre	1
30	M20, M21, M33 (rigid and spring)	65-5380	Steering damper friction washer	2
31	M20, M21, M33 (rigid and spring)	65-5410	Fork sliding tube (offside) complete (7" brake)	1
31	M20, M21, M33 (rigid and spring)	65-5420	Front fork sliding tube (offside) complete (8" brake)	1
32	M20, M21, M33 (rigid and spring)	66-5089	Front fork bottom yoke	1
33	M20, M21, M33 (rigid and spring)	65-5435	Front fork bottom yoke bolt	2
33	M21 AA Model	29-5289	Front fork bottom yoke bolt	2
34	M20, M21, M33 (rigid and spring)	36-332	Front fork bottom yoke bolt nut washer	2
35	M20, M21, M33 (rigid and spring)	24-5160	Front fork bottom yoke bolt nut	2
36	M20, M21, M33 (spring)	67-5014	Front fork shaft (8" brake)	2
—	M20, M21, M33 (rigid)	89-5061	Front fork shaft (8" brake)	2
37	M20, M21, M33 (rigid and spring)	29-5347	Front fork bottom bearing	2
38	M20, M21, M33 (rigid and spring)	29-5283	Front fork shaft plug	2
—	M20, M21, M33 (rigid and spring)	29-5338	Fork plug washer	2
39	M20, M21, M33 (rigid and spring)	2-2903	Fork end bolt washer (spring)	1
40	M20, M21, M33 (rigid and spring)	2-292	Fork end drain plug washer	2
41	M20, M21, M33 (rigid and spring)	2-1309	Fork end drain plug	2
42	M20, M21, M33	65-5295	Fork end bolt (nearside)	1
43	M20, M21, M33 (rigid and spring)	65-5408	Fork sliding tube (nearside) complete (7" brake)	1
43	M20, M21, M33 (rigid and spring)	67-5057	Fork sliding tube (nearside) complete (8" brake)	1
44	M20, M21, M33 (rigid and spring)	29-5346	Front fork top bearing	2
44	M20, M21, M33 (rigid)	65-5424	Front fork top bearing	2
45	M20, M21, M33 (rigid and spring)	29-5320	Top bearing circlip	2
46	M20, M21, M33 (rigid and spring)	29-5313	Front fork oil seal	2
47	M20, M21, M33 (rigid and spring)	65-5448	Front fork top yoke	1
48	M20, M21, M33	65-5445	Steering head lock	1
—	(rigid and spring)	65-5446	Steering head lock grub screw	1

Front Hub and Wheel Fittings

Rear Hub and Wheel Fittings

Mudguards Oil Tank Toolbox and Chainguards

Petrol Tank Handlebar Dual Seat Battery Carrier and Silencer

Rear Mudguard Toolbox Chainguards Rear Brake Control and Silencer

Special Components as supplied to Automobile Association

Legshields

Tools and Sundries

Electrical Equipment

Front and Rear Safety Bar Safety Bar and Legshield

Sidcar Chassis

Carrier Pannier



## Plate 9A

## FRONT FORK and FITTINGS

M21 Spring Frame (1958)

Plate Ref. Number	Model	Part No.	Description	Number per set
1	M21	65-5446	Steering head lock grub screw	1
2	M21	65-5447	Front fork top yoke	1
3	M21	65-5332	Front fork tube nut washer	2
4	M21	65-5331	Front fork tube nut	2
5	M21	66-5097	Front fork top yoke clip bolt nut	1
6	M21	65-5445	Steering head lock	1
7	M21	67-5023	Steering stem adjusting sleeve	1
8	M21	67-5024	Steering stem adjusting sleeve cap	1
9	M21	65-5334	Handlebar and yoke clip bolt	4
10	M21	15-5155	Handlebar and yoke clip bolt washer (plain)	4
11	M21	65-5333	Handlebar clip	2
12	M21	27-5135	Front fork top yoke clip bolt	1
13	M21	67-5021	Steering damper adjusting rod	1
14	M21	24-6035	Steering damper knob washer (spring)	1
15	M21	65-5380	Steering damper friction washer	1
16	M21	27-5152	Steering damper anchor plate	1
17	M21	25-5247	Steering damper star washer	1
18	M21	65-532S	Steering damper centre	1
19	M21	66-5204	Steering head dust cap	1
20	M21	65-5126	Steering head ballrace cone (top)	1
21	M21	1-4675	Steering head balls	40
22	M21	65-5127	Steering head ballrace cone (bottom)	1
23	M21	35-701	Steering damper rod split pin	1
24	M21	25-2541	Steering damper bottom plate	1
25	M21	36-382	Steering damper anchor plate stud lock washer (shakeproof)	1
26	M21	2-49	Steering damper anchor plate stud nut	1
27	M21	2-923	Steering damper anchor plate stud washer (plain)	1
28	M21	65-5327	Steering damper anchor plate stud	1
29	M21	89-5061	Front fork shaft	2
30	M21	67-5044	Front fork outer sleeve (o/s)	1
31	M21	67-5042	Front fork outer sleeve (n/s)	1
32	M21	89-5036	Front fork spring (solo machines)	2
32	M21	65-5391	Front fork spring (sidecar machines)	2
33	M21	29-5310	Front fork oil seal holder	2
34	M21	29-5313	Front fork oil seal	2
35	M21	29-5320	Front fork top bearing circlip	2
36	M21	65-5424	Front fork top bearing	2
37	M21	29-5347	Front fork bottom bearing	2
38	M21	29-5338	Front fork shaft plug washer	2
39	M21	29-5283	Front fork shaft plug	2
40	M21	2-1309	Fork end drain plug	2
41	M21	2-292	Fork end drain plug washer	2
42	M21	67-5057	Front fork sliding tube (n/s)	1
43	M21	2-2903	Front fork end bolt washer	1
44	M21	65-5295	Front fork end bolt (n/s)	1
45	M21	65-5420	Front fork sliding tube (o/s)	1
46	M21	24-5160	Bottom yoke bolt nut	2
47	M21	66-5089	Front fork bottom yoke	1
48	M21	36-382	Front fork bottom yoke washer	2
49	M21	29-5289	Front fork bottom yoke bolt	2



FRONT FORK and FITTINGS

M21 Spring Frame (1958)

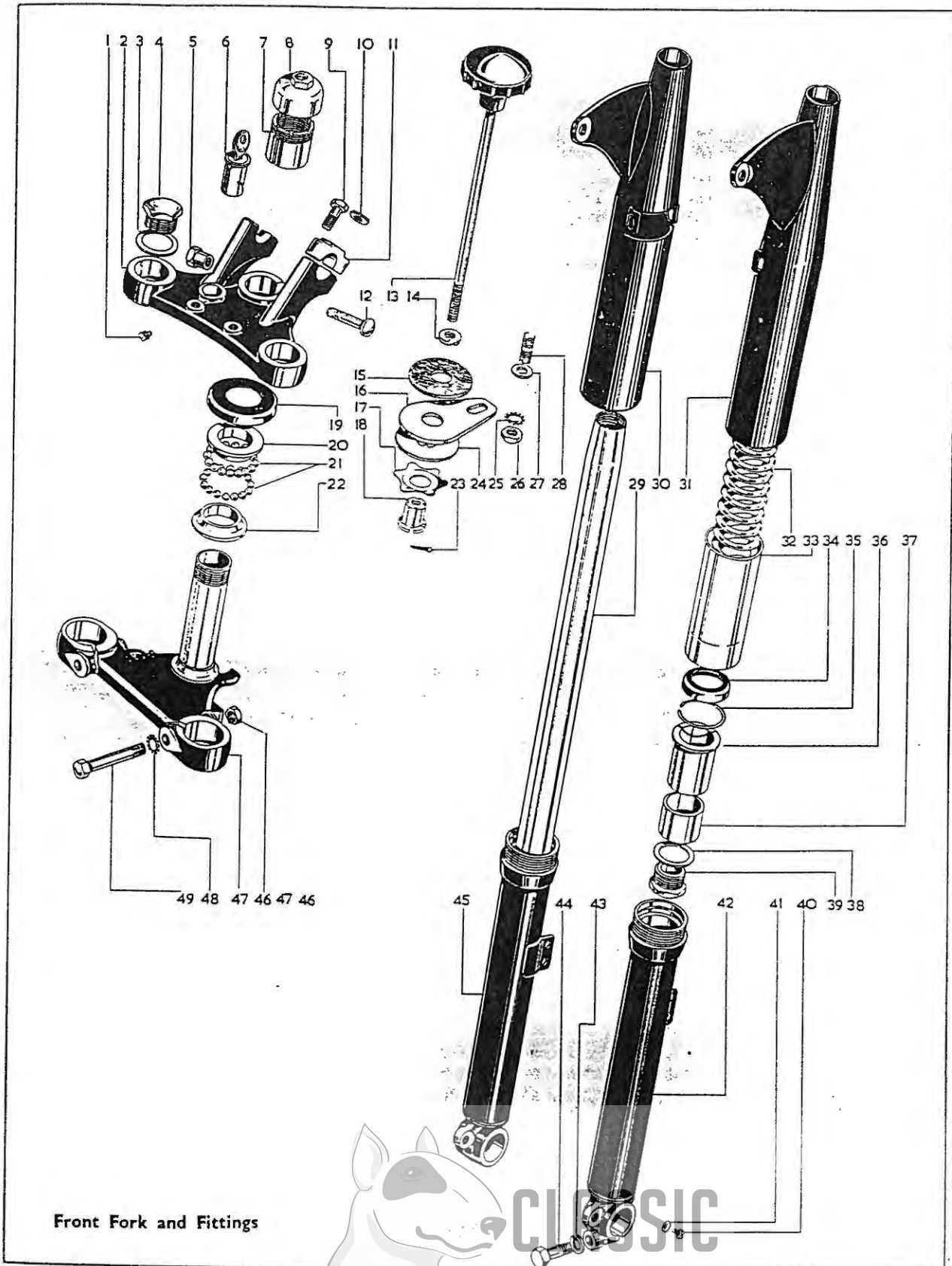

Front Fork and Fittings

Front Hub and Wheel Fittings

Rear Hub and Wheel Fittings

Mudguards Oil Tank Toolbox and Chainguards

Patrol Tank Handlebar Dual Seat Battery Carrier and Silencer

Rear Mudguard Toolbox Chainguards Rear Brake Control and Silencer

Special Components as supplied to Automobile Association

Legshields

Tools and Sundries

Electrical Equipment

Front and Rear Safety Bars, Safety Bars and Legshields

Sidecar Chassis

Carrier and Pannier

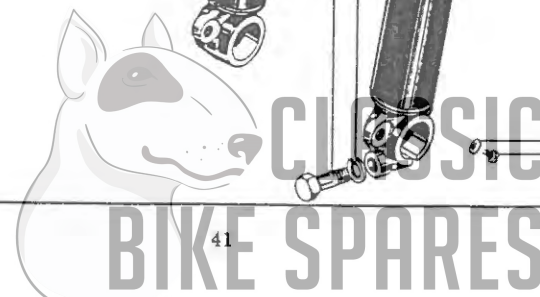

# FRONT HUB and WHEEL FITTINGS

"M" Group (Rigid and Spring Frame) (7" brake)

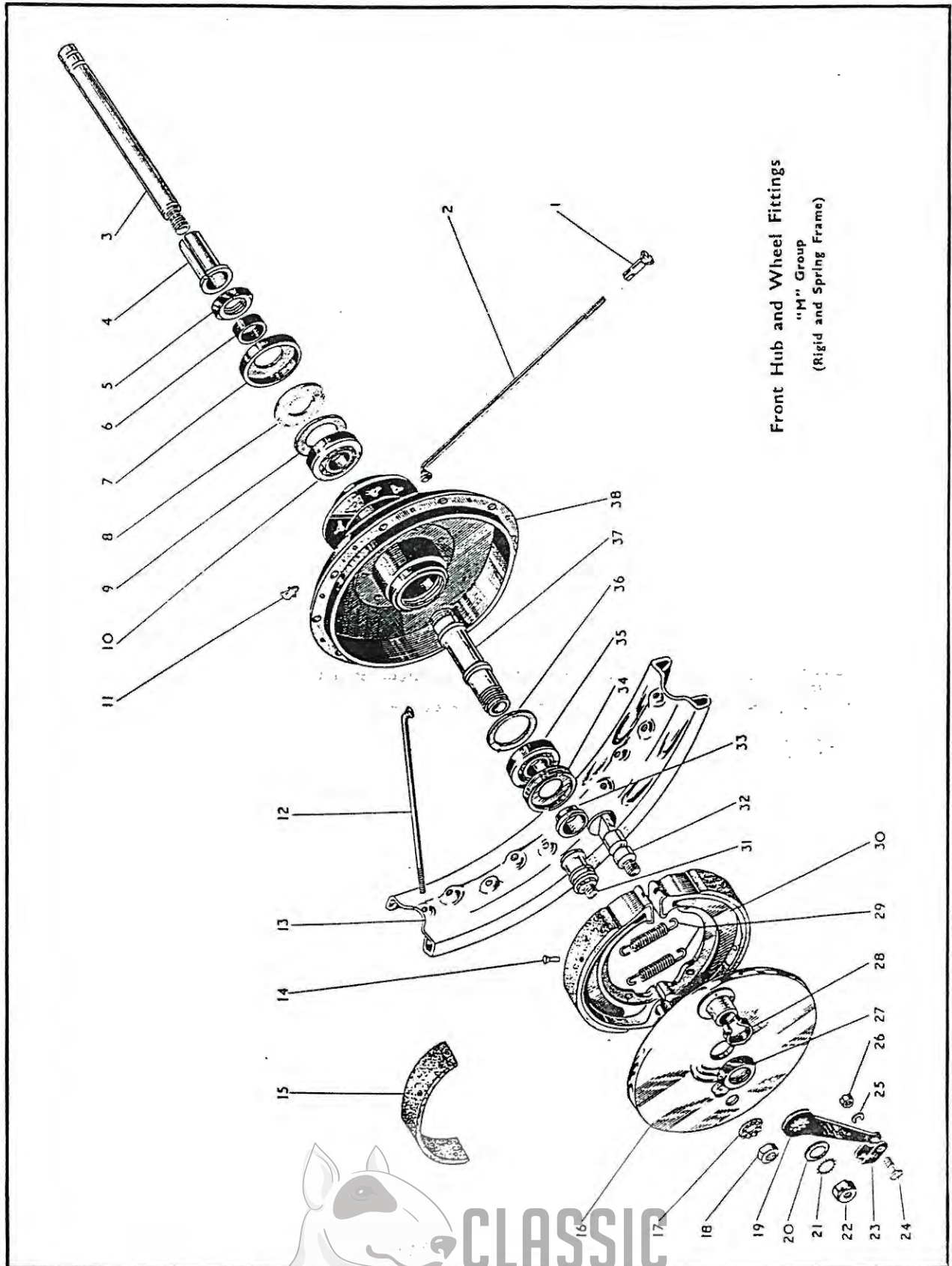

Front Hub and Wheel Fittings  
"M" Group  
(Rigid and Spring Frame)

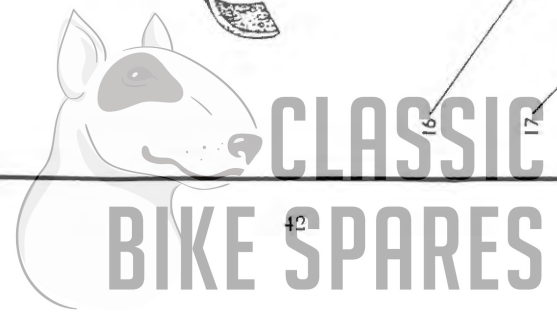



FRONT HUB and WHEEL FITTINGS

"M" Group (Rigid and Spring Frame) (7" Brake)

Plate Ref. Number.	Model.	Part No.	Description.	Number per set.
1	... Rigid and Spring Frame	27-6813	Front wheel spoke nipple	40
2	... Rigid and Spring Frame	65-5872	Front wheel spoke (long)	20
3	... Rigid and Spring Frame	65-5929	Front hub spindle complete	1
4	... Rigid and Spring Frame	65-5892	Front hub spindle distance piece	1
5	... Rigid and Spring Frame	65-5893	Front wheel cover plate nut	1
6	... Rigid and Spring Frame	65-5890	Front hub distance collar	1
7	... Rigid and Spring Frame	65-5888	Front hub felt washer retaining cup	1
8	... Rigid and Spring Frame	65-5886	Front hub felt washer	1
9	... Rigid and Spring Frame	65-5887	Front hub felt washer retaining ring	1
10	... Rigid and Spring Frame	65-5883	Front hub ball journal	1
11	... Rigid and Spring Frame	15-5290	Front hub grease nipple	1
12	... Rigid and Spring Frame	65-5910	Front wheel spoke (short)	20
—	... Rigid and Spring Frame	65-5870/44	Front wheel complete (less brake and tyre)	1
13	... Rigid and Spring Frame	67-5543/3	Front wheel rim	1
14	... Rigid and Spring Frame	35-6436	Front brake shoe lining rivet	14
15	... Rigid and Spring Frame	65-5903	Front brake shoe lining	2
16	... Rigid and Spring Frame	65-5895	Front brake cover plate complete	1
17	... Rigid and Spring Frame	24-8045	Front brake shoe fulcrum pin washer (serrated)	1
18	... Rigid and Spring Frame	24-5860	Front brake shoe fulcrum pin nut	1
19	... Rigid and Spring Frame	65-5907	Front brake shoe cam lever	1
20	... Rigid and Spring Frame	15-431	Front brake shoe cam washer	1
21	... Rigid and Spring Frame	66-4708	Front brake shoe cam washer (shakeproof)	1
22	... Rigid and Spring Frame	2-440	Front brake shoe cam nut	1
23	... Rigid and Spring Frame	29-5871	Front brake cable toggle end	1
24	... Rigid and Spring Frame	2-510	Front brake cable toggle end screw	1
25	... Rigid and Spring Frame	2-1462	Front brake cable toggle end washer (spring)	1
26	... Rigid and Spring Frame	2-443	Front brake cable toggle end screw nut	1
27	... Rigid and Spring Frame	65-5893	Front wheel cover plate nut	1
28	... Rigid and Spring Frame	65-5674	Front brake shoe cam bearing oil hole clip	1
29	... Rigid and Spring Frame	65-5904	Front brake shoe spring	2
30	... Rigid and Spring Frame	65-5901	Front brake shoe complete	2
31	... Rigid and Spring Frame	65-5899	Front brake shoe fulcrum pin	1
32	... Rigid and Spring Frame	65-5905	Front brake cam complete	1
33	... Rigid and Spring Frame	65-5891	Front hub distance piece	1
34	... Rigid and Spring Frame	65-5885	Front hub bearing retaining ring	1

Front Hub and Wheel Fittings

Rear Hub and Wheel Fittings

Mudguards Oil Tank Toolbox and Chainguards

Petrol Tank Handlebar Dual Seat Battery Carrier and Silencer

Rear Mudguard Toolbox Chainguards Rear Brake Control and Silencer

Special Components as supplied to Automobile Association

Legshields

Tools and Sundries

Electrical Equipment

Front and Rear Safety Bars Safety Bars and Legshield

Sidcar Chassis

Carrier Pannier



# FRONT HUB and WHEEL FITTINGS

M Group (Rigid and Spring Frame) (8" Brake)

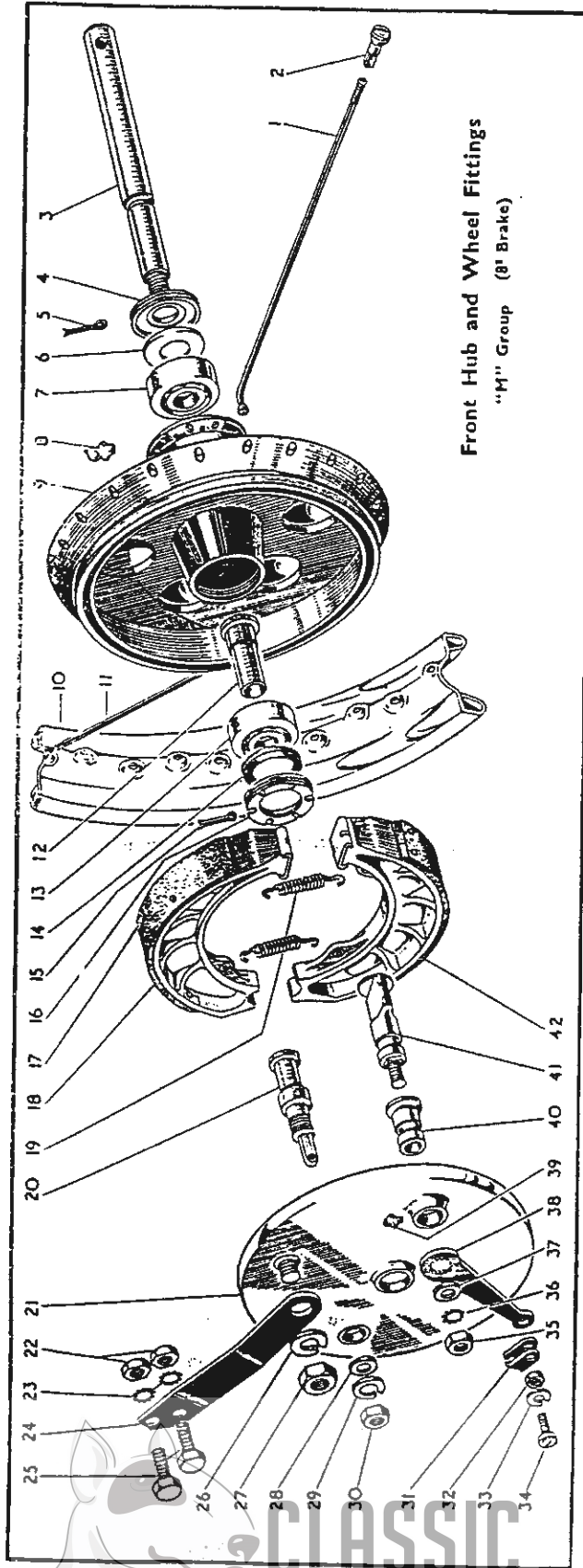

Front Hub and Wheel Fittings  
"M" Group (8" Brake)

When ordering components with varying finishes—i.e., Wheels, Hubs and Rims, please state state finish required by adding the appropriate Suffix Number to the Part Number  
EXAMPLE:—Front Wheel complete (less brake and tyre), 65-5850/44

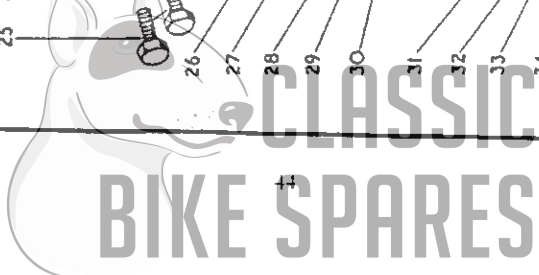



Plate 10—continued

FRONT HUB and WHEEL FITTINGS

"M" Group (Rigid and Spring Frame) (7" Brake)

Plate Ref. Number.	Models.	Part No.	Description.	Number per set.
35	Rigid and Spring Frame	65-5883	Front hub ball journal	1
36	Rigid and Spring Frame	65-5884	Front hub bearing thrust washer	1
37	Rigid and Spring Frame	65-5889	Front hub spindle sleeve	1
38	Rigid and Spring Frame	65-5876	Front hub complete with spindle and bearings (less brake)	1

Plate 11

FRONT HUB and WHEEL FITTINGS

"M" Group (Rigid and Spring Frame) (8" Brake)

Plate Ref. Number.	Models.	Part No.	Description.	Number per set
—	M20, AA (rigid)	66-5554	Front wheel complete (less brake and tyre)	1
—	M20, M21, M33 (rigid and spring)	67-5542/44	Front wheel complete (less brake and tyre) (up to 1955)	1
—	M20, M21, M33 (rigid and spring)	67-5605	Front wheel complete (less brake and tyre)	1
1	M20, M21, M33 (rigid and spring)	66-5561	Front wheel spoke (short)	20
2	M20, M21, M33 (rigid and spring)	27-6813	Front wheel spoke nipple	40
3	M20, M21, M33 (rigid and spring)	67-5566	Front hub spindle	1
4	M20, M21, M33 (rigid and spring)	67-5561	Front hub bearing locking ring (nearside)	1
5	M20, M21, M33 (rigid and spring)	35-701	Front hub bearing locking ring retaining pin	1
6	M20, M21, M33 (rigid and spring)	67-5563	Front hub bearing oil retaining washer (nearside)	1
7	M20, M21, M33 (rigid and spring)	65-5883	Front hub ball journal	1
8	M20, M21, M33 (rigid and spring)	28-2080	Front hub grease nipple	1
9	M20, M21, M33 (rigid and spring)	67-5547	Front hub shell with spindle and bearings (up to 1955)	1
9	M20, M21, M33 (rigid and spring)	66-5556	Front hub complete with spindle, sleeve and bearings	1
10	M20, M21, M33 (rigid and spring)	67-5543/3	Front wheel rim	1
11	M20, M21, M33 (rigid and spring)	67-5545	Front wheel spoke (long) (up to 1955)	20
11	M20, M21, M33 (rigid and spring)	67-5606	Front wheel spoke (long)	20
11	M21 AA (rigid)	66-5555	Front wheel spoke (long)	20
12	M20, M21, M33 (rigid and spring)	67-5565	Front hub spindle sleeve	1
13	M20, M21, M33 (rigid and spring)	65-5883	Front hub ball journal	1
14	M20, M21, M33 (rigid and spring)	67-5564	Front hub bearing oil retaining washer (offside)	1
15	M20, M21, M33 (rigid and spring)	35-701	Front hub bearing locking ring retaining pin	1
16	M20, M21, M33 (rigid and spring)	67-5562	Front hub bearing locking ring (offside)	1
17	M20, M21, M33 (rigid and spring)	67-5575	Front brake shoe lining rivet	14
18	M20, M21, M33 (rigid and spring)	67-5571	Front brake shoe lining	2
19	M20, M21, M33 (rigid and spring)	65-5904	Front brake shoe spring	2
20	M20, M21, M33 (rigid and spring)	67-5576	Front brake fulcrum and adjusting pin	1

Rear Hub and Wheel Fittings

Mudguards Oil Tank Toolbox and Chainguards

Petrol Tank Handlebar Dual Seat Battery Carrier and Silencer

Rear Mudguard Toolbox Chainguards Rear Brake Control and Silencer

Special Components as supplied to Automobile Association

Legshields

Tools and Sundries

Electrical Equipment

Front and Rear Safety Bars Safety Bars and Legshield

Sidecar Chassis

Carrier Pannier



## Plate 11—continued

## FRONT HUB and WHEEL FITTINGS

"M" Group (Rigid and Spring Frame) (8" Brake)

Plate Ref. Number.	Models.	Part No.	Description.	Number per set.
21	M20, M21, M33 (rigid and spring)	67-5555/21	Front brake cover plate with fixed fittings	1
22	M20, M21, M33 (rigid and spring)	2-49	Front brake anchor strap nut (1955)	1
23	M20, M21, M33 (rigid and spring)	36-382	Front brake anchor strap nut washer (1955)	2
24	M20, M21, M33 (rigid and spring)	67-5578	Front brake anchor strap	1
25	M20, M21, M33 (rigid and spring)	32-194	Front brake anchor strap and mudguard bridge bolt	2
26	M20, M21, M33 (rigid and spring)	15-716	Front brake cover plate and anchor strap spring washer	1
27	M20, M21, M33 (rigid and spring)	15-541	Front brake cover plate and anchor strap nut	1
28	M20, M21, M33 (rigid and spring)	25-6014	Front brake fulcrum and adjusting pin washer	1
29	M20, M21, M33 (rigid and spring)	35-37	Front brake fulcrum and adjusting pin spring washer	1
30	M20, M21, M33 (rigid and spring)	2-2527	Front brake fulcrum and adjusting pin nut	1
31	M20, M21, M33 (rigid and spring)	29-5871	Front brake lever toggle	1
32	M20, M21, M33 (rigid and spring)	2-443	Front brake lever toggle nut	1
33	M20, M21, M33 (rigid and spring)	2-1462	Front brake lever toggle washer	1
34	M20, M21, M33 (rigid and spring)	2-510	Front brake lever toggle screw	1
35	M20, M21, M33 (rigid and spring)	2-440	Front brake shoe cam nut	1
36	M20, M21, M33 (rigid and spring)	66-4708	Front brake shoe cam washer	1
37	M20, M21, M33 (rigid and spring)	15-431	Front brake shoe cam washer (plain)	1
38	M20, M21, M33 (rigid and spring)	65-5907	Front brake operating lever	1
39	M20, M21, M33 (rigid and spring)	23-2080	Front brake fulcrum pin grease nipple	1
40	M20, M21, M33 (rigid and spring)	67-5567	Front brake cam bearing	1
41	M20, M21, M33 (rigid and spring)	67-5572	Front brake shoe cam complete	1
42	M20, M21, M33 (rigid and spring)	67-5558	Front brake shoe with lining	2

## Plate 12

## REAR HUB and WHEEL FITTINGS

"M" Group (Rigid Frame)

Plate Ref. Number.	Model.	Part No.	Description.	Number per set.
—	M20, M21, M33	66-6076	Rear wheel complete (less brake and tyre)	1
—	M21 A.A.	66-6268	Rear wheel complete (less brake and tyre)	1
1	M20, M21, M33	15-7037	Rear wheel spoke (left-hand)	20
2	M20, M21, M33	66-6265	Rear hub spindle	1
3	M20, M21, M33	24-6896	Rear wheel spoke (right-hand)	20
4	M20, M21, M33	27-6812	Rear wheel spoke nipple	40
5	M20, M21, M33	24-6846	Rear hub felt washer retaining cup	2
6	M20, M21, M33	66-6274	Rear hub washer	2
7	M20, M21, M33	24-7133	Rear hub spindle nut	1
8	M20, M21, M33	66-6273	Rear hub locknut	1
9	M20, M21, M33	66-5541	Rear hub barrel cap	1
10	M20, M21, M33	66-5524	Rear hub washer (steel)	1
11	M20, M21, M33	24-898	Rear hub adjusting sleeve locknut	1
12	M20, M21, M33	24-6867	Rear hub adjusting sleeve	1
13	M20, M21, M33	66-5525	Rear hub felt washer	1
14	M20, M21, M33	24-6860	Rear hub bearing	1



"M" Group (Rigid and Spring Frame)

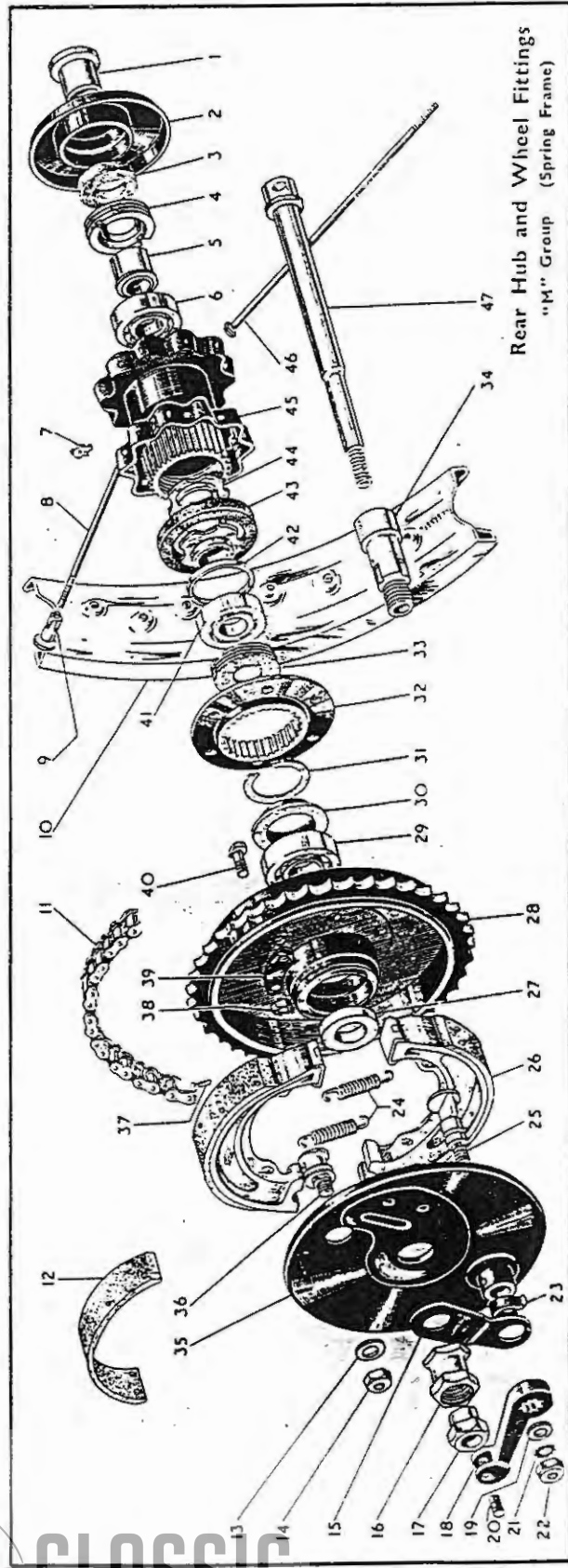
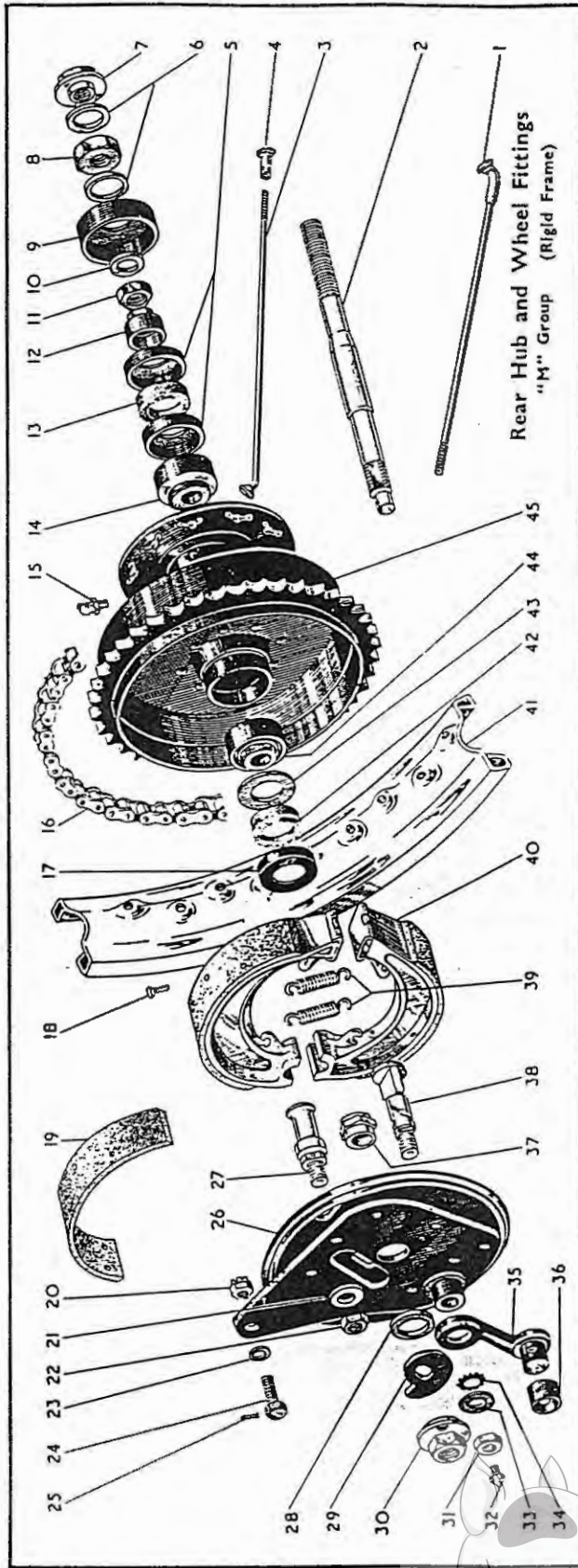

Rear Hub and Wheel Fittings

Mudguards  
Oil Tank  
Toolbox and  
Chainguards

Petrol Tank  
Handlebar  
Dual Seat  
Battery Carrier  
and Silencer

Rear Mudguard  
Toolbox  
Chainguards  
Rear Brake  
Control  
and Silencer

Special  
Components  
as supplied to  
Automobile  
Association

Legshields

Tools and  
Sundries

Electrical  
Equipment

Front and Rear  
Safety Bars,  
Safety Bars  
and Legshields

Sidocar  
Chassis

Carrier  
Pannier

CLASSIC  
BIKE SPARES



## REAR HUB and WHEEL FITTINGS

"M" Group (Rigid Frame)

Plate Ref. Number.	Models.	Part No.	Description.	Number per set
15	M20, M21, M33	28-2080	Rear hub grease nipple	1
16	M20, M21, M33	24-8713	Transmission chain (rear)	1
17	M20, M21, M33	24-6846	Rear hub felt washer retaining cup	1
18	M20, M21, M33	35-6436	Rear brake shoe rivets	14
19	M20, M21, M33	35-6432	Rear brake shoe lining	2
20	M20, M21, M33	15-1166	Rear brake anchor bolt nut	1
21	M20, M21, M33	66-6098	Rear brake cover plate with fixed fittings	1
22	M20, M21, M33	15-1455	Rear brake fulcrum pin nut	1
23	M20, M21, M33	2-2138	Rear brake anchor bolt washer	1
24	M20, M21, M33	24-209	Rear brake anchor bolt	1
25	M20, M21, M33	66-6257	Rear brake anchor bolt split pin	1
26	M20, M21, M33	33-5545	Rear brake fulcrum pin washer	1
27	M20, M21, M33	33-5544	Rear brake fulcrum pin	1
28	M20, M21, M33	66-6274	Rear hub washer	1
29	M20, M21, M33	66-6256	Rear wheel adjusting plate	1
30	M20, M21, M33	24-7133	Rear hub spindle nut	1
31	M20, M21, M33	2-440	Rear brake operating rod nut	1
32	M20, M21, M33	28-2080	Rear brake cam grease nipple	1
33	M20, M21, M33	15-431	Rear brake operating lever washer (plain)	1
34	M20, M21, M33	66-4708	Rear brake operating lever washer (shakeproof)	1
35	M20, M21, M33	15-7961	Rear brake operating lever complete	1
36	M20, M21, M33	65-7037	Rear brake operating rod bush	1
37	M20, M21, M33	66-6255	Rear hub bearing locknut	1
38	M20, M21, M33	24-7127	Rear brake cam complete	1
39	M20, M21, M33	35-6440	Rear brake shoe spring	2
40	M20, M21, M33	35-9235	Rear brake shoe complete	2
41	M20, M21, M33	66-6077	Rear wheel rim	1
41	M21 AA	66-6054	Rear wheel rim	1
41	M20, M21, M33	66-6054/3	Rear wheel rim (up to 1955)	1
42	M20, M21, M33	66-5525	Rear hub felt washer	1
43	M20, M21, M33	29-5841	Rear hub retaining washer	1
44	M20, M21, M33	24-6860	Rear hub bearing	1
45	M20, M21, M33	66-6259	Rear hub shell complete with bearings	1

## Plate 13.

## REAR HUB and WHEEL FITTINGS

"M" Group (Spring Frame).

Plate Ref. Number.	Model.	Part No.	Description.	Number per set
1	M20, M21, M33	67-6066	Hub distance piece (R/H)	1
2	M20, M21, M33	67-6128	Rear hub shell cover assembly	1
3	M20, M21, M33	67-6075	Rear hub felt washer	1
4	M20, M21, M33	67-6076	Rear hub bearing lockring	1
5	M20, M21, M33	67-6077	Hub collar (right-hand)	1
6	M20, M21, M33	65-5883	Rear hub bearing	1
7	M20, M21, M33	15-5290	Rear hub grease nipple	1
8	M20, M21, M33	67-6017	Rear wheel spoke (nearside)	20
9	M20, M21, M33	27-6813	Rear wheel spoke nipple	40
—	M20, M21, M33	67-6012	Rear wheel complete (less brake and tyre)	1
10	M20, M21, M33	67-6005/3	Rear wheel rim	1
11	M20, M21, M33	66-9162	Transmission chain (rear)	1
12	M20, M21, M33	65-5903	Rear brake shoe lining	2
13	M20, M21, M33	24-8045	Rear brake fulcrum pin washer (serrated)	1
14	M20, M21, M33	24-5860	Rear brake fulcrum pin nut	1
15	M20, M21, M33	67-6081	Brake lever steady strap	1
16	M20, M21, M33	67-6074	Rear hub bearing sleeve nut	1
17	M20, M21, M33	67-6073	Rear hub spindle nut	1
18	M20, M21, M33	65-6279	Rear brake operating lever	1
19	M20, M21, M33	15-431	Rear brake operating rod washer (plain)	1
20	M20, M21, M33	65-6274	Rear brake rod swivel pin	1
21	M20, M21, M33	66-4708	Rear brake operating rod washer (shakeproof)	1
22	M20, M21, M33	2-440	Rear brake operating rod nut	1
23	M20, M21, M33	65-5674	Rear brake cam oil hole clip	1
24	M20, M21, M33	65-5904	Rear brake shoe spring	2
25	M20, M21, M33	65-5905	Rear brake cam complete	1



Plate 13—continued REAR HUB and WHEEL FITTINGS

"M" Group (Spring Frame)

Plate Ref. Number.	Model.	Part No.	Description.	Number per set.
26	M20, M21, M33	65-5901	Rear brake shoe complete	2
27	M20, M21, M33	67-6078	Hub collar (left-hand) (up to 1955)	2
28	M20, M21, M33	65-6294	Brake drum and chainwheel	1
29	M20, M21, M33	89-3022	Brake drum and chainwheel ball bearing	1
30	M20, M21, M33	67-6072	Ball bearing shim	1
31	M20, M21, M33	67-6067	Ball bearing retaining ring	1
32	M20, M21, M33	67-6101	Driving flange	1
33	M20, M21, M33	67-6076	Rear hub bearing lockring	1
34	M20, M21, M33	67-6060	Rear hub bearing sleeve	1
35	M20, M21, M33	67-6085	Rear brake cover plate with fixed fittings (up to 1955)	1
36	M20, M21, M33	65-5899	Rear brake fulcrum pin	1
37	M20, M21, M33	35-6436	Rear brake shoe rivets	14
38	M20, M21, M33	2-452	Rear hub chainwheel bolt nut	6
39	M20, M21, M33	67-6039	Rear hub chainwheel bolt lockstrip	3
40	M20, M21, M33	67-6038	Rear hub chainwheel bolt	6
41	M20, M21, M33	65-5883	Rear hub bearing	1
42	M20, M21, M33	65-5884	Rear hub bearing thrust washer	1
43	M20, M21, M33	67-6051	Rear hub shell washer (rubber)	1
44	M20, M21, M33	67-6061	Hub bearing distance tube and retainers	1
45	M20, M21, M33	67-6126	Rear hub shell complete with bearings	1
46	M20, M21, M33	67-6016	Rear wheel spoke (offside)	20
47	M20, M21, M33	67-6164	Rear hub spindle	1

Plate 14 Mudguards, Oil Tank, Toolbox and Chainguards

"M" Group

Plate Ref. Number.	Model.	Part No.	Description.	Number per set.
1	M20, M21, M33 (rigid)	1-4606	Bottom chainguard fixing screw	3
2	M20, M21, M33 (rigid)	26-9461	Bottom chainguard fixing screw washer (plain)	3
3	M20, M21, M33 (rigid)	29-3319	Bottom chainguard fixing screw washer (shakeproof)	3
4	M20, M21, M33 (rigid)	25-7151	Bottom chainguard fixing screw nut	3
5	M20, M21, M33 (rigid)	15-8833	Bottom chainguard	1
6	M20, M21, M33 (rigid)	29-541	Rear chainguard securing washer (shakeproof)	1
7	M20, M21, M33 (rigid)	2-51	Rear chainguard securing nut	1
8	M20, M21, M33 (rigid and spring)	15-447	Front stand mudguard fixing bolt nut	2
9	M20, M21, M33 (rigid and spring)	65-6608	Front stand complete (up to 1955)	1
9	M20, M21, M33 (rigid and spring)	67-6530	Front stand complete	1
10	M20, M21, M33 (rigid and spring)	2-1934	Front stand fork and fixing bolt	2
11	M20, M21, M33 (rigid and spring)	15-7354	Mudguard stay and fork end bolt	2
12	M20, M21, M33 (rigid and spring)	65-6607	Front mudguard stay (up to 1955)	1
12	M20, M21, M33 (rigid and spring)	67-6544	Front mudguard stay	1
—	M20, M21, M33 (rigid and spring)	67-6546	Front mudguard bridge stay insulator (rubber)	2
—	M20, M21, M33 (rigid and spring)	67-6547	Front mudguard bridge stay insulator (rubber)	2
13	M20, M21, M33 (rigid and spring)	24-8784	Front stand fork end fixing bolt washer (spring)	2
14	M20, M21, M33 (rigid and spring)	2-1616	Front stand fork end fixing bolt nut	2

Mudguards  
Oil Tank  
Toolbox and  
Chainguards

Petrol Tank  
Handlebar  
Dual Seat  
Battery Carrier  
and Silencer

ear Mudguard  
Toolbox  
Chainguards  
Rear Brake  
Control  
and Silencer

Special  
Components  
as supplied to  
Automobile  
Association

Legshields

Tools and  
Sundries

Electrical  
Equipment

Front and Rear  
Safety Bars,  
Safety Bars  
and Legshields

Sidecar  
Chassis

Carrier  
Panniers

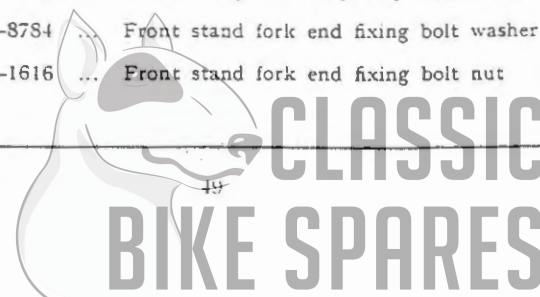
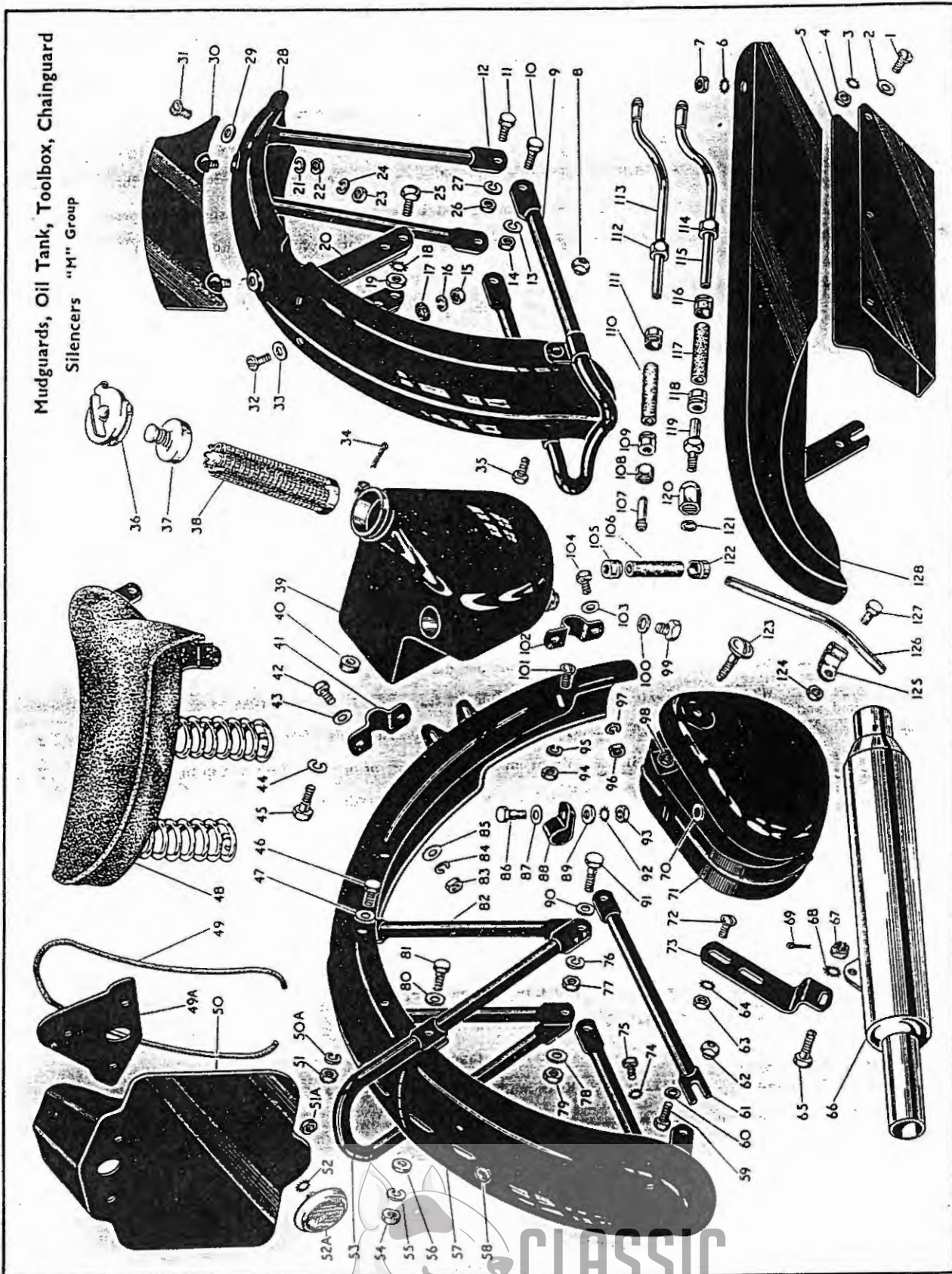

Plate Ref. Number.	Models.	Part No.	Description.	Number per set.
15	M20, M21, M33 (rigid and spring)	2-2395	Front mudguard support bridge fixing screw nut	2
16	M20, M21, M33 (rigid and spring)	2-1462	Front mudguard support bridge fixing screw washer (spring)	2
17	M20, M21, M33 (rigid and spring)	66-7518	Front mudguard support bridge fixing screw washer (fibre)	2
18	M20, M21, M33 (rigid and spring)	36-382	Front mudguard bridge fork fixing bolt washer (shakeproof)	4
19	M20, M21, M33 (rigid and spring)	2-49	Front mudguard bridge fork fixing bolt nut	4
20	M20, M21, M33 (rigid and spring)	65-6623	Front mudguard support bridge	1
21	M20, M21, M33 (rigid and spring)	2-1462	Front number plate fixing stud washer (spring)	2
22	M20, M21, M23 (rigid and spring)	2-2395	Front number plate fixing stud nut	2
23	M20, M21, M33 (rigid and spring)	2-2395	Front mudguard stay fixing bolt nut	2
24	M20, M21, M33 (rigid and spring)	2-1462	Front mudguard stay fixing bolt washer (spring)	2
25	M20, M21, M33 (rigid and spring)	28-2338	Front mudguard bridge fork fixing bolt	2
25	M20, M21, M33 (rigid and spring)	15-7354	Front mudguard stay fork end fixing bolt	2
26	M20, M21, M33 (rigid and spring)	2-1616	Mudguard stay fork and fixing bolt nut	2
27	M20, M21, M33 (rigid and spring)	24-8784	Mudguard stay fork end fixing bolt washer (spring)	2
28	M20, M21, M33 (rigid and spring)	65-6605	Front mudguard with fixed fittings (up to 1955)	1
28	M20, M21, M33 (rigid and spring)	67-6543	Front mudguard with fixed fittings...	1
29	M20, M21, M33 (rigid and spring)	27-8560	Front mudguard stay fixing bolt washer	2
30	M20, M21, M33 (rigid and spring)	65-6576	Front number plate complete	1
31	M20, M21, M33 (rigid and spring)	15-7161	Front mudguard stay fixing bolt (up to 1955)	2
31	M20, M21, M33 (spring)	2-220	Front mudguard stay fixing bolt	2
32	M20, M21, M33 (rigid and spring)	15-7161	Front mudguard support bridge fixing screw (up to 1955)	2
32	M20, M21, M33 (rigid and spring)	2-220	Front mudguard support bridge fixing bolt	2
33	M20, M21, M33 (rigid and spring)	27-8560	Front mudguard support bridge fixing screw washer	2
34	M20, M21, M33 (rigid and spring)	35-707	Oil tank filler cap split pin...	1
35	M20, M21, M33 (rigid and spring)	2-1354	Front stand mudguard fixing bolt...	2
36	M20, M21, M33 (rigid and spring)	66-8351	Oil tank filler cap	1
37	M20, M21, M33 (rigid and spring)	66-8358	Oil filter cap (top) complete	1
38	M20, M21, M33 (rigid and spring)	66-8359	Oil filter element complete	1
39	M20, M21, M33 (rigid and spring)	65-8442	Oil tank with fixed fittings	1
40	M20, M21, M33 (rigid and spring)	66-8347	Oil tank distance collar	3
41	M20, M21, M33 (rigid)	2-2276	Rear mudguard backstay bridge clip	1
42	M20, M21, M33 (rigid)	2-204	Rear mudguard backstay bridge clip bolt	2
43	M20, M21, M33 (rigid)	27-8560	Rear mudguard backstay bridge clip bolt washer	2
44	M20, M21, M33 (rigid and spring)	24-8784	Oil tank fixing bolt washer (spring)	3
45	M20, M21, M33 (rigid and spring)	15-480	Oil tank fixing bolt	3



Plate 14 MUDGUARDS, OIL TANK, TOOLBOX and CHAINGUARDS  
"M" Group



Petrol Tank  
Handlebar  
Dual Seat  
Battery Carrier  
and Silencer

ear Mudguard  
Toolbox  
Chainguards  
Rear Brake  
Control  
and Silencer

Special  
Components  
as supplied to  
Automobile  
Association

Legshields

Tools and  
Sundries

Electrical  
Equipment

Front and Rear  
Safety Bars,  
Safety Bars  
and Legshields

Sidescar  
Chassis

Carrier a  
Pannier

CLASSIC  
BIKE SPARES



Plate Ref. Number.	Model.	Part No.	Description.	Number per set.
46	M20, M21, M33 (rigid)	2-204	Rear mudguard upright stay fixing bolt	2
47	M20, M21, M33 (rigid)	27-8560	Rear mudguard upright stay fixing bolt washer	2
48	M20, M21, M33 (spring)	66-9207	Saddle	1
48	M20, M21, M33 (rigid)	66-9206	Saddle	1
49	M20, M21, M33 (rigid and spring)	67-6851	Rear number plate rubber extrusion	1
49A	M20, M21, M33 (rigid)	66-6820	Reflector mounting plate (1955)	1
50	M20, M21, M33 (spring)	67-6885	Rear number plate complete	1
50	M20, M21, M33 (rigid and spring)	67-6830	Rear number plate complete (drilled with small hole for reflector (1955).	1
—	M20, M21, M33 (rigid and spring)	2-220	Rear number plate fixing bolt	4
—	M20, M21, M33 (rigid and spring)	2-1462	Rear number plate fixing bolt washer (spring)	4
—	M20, M21, M33 (rigid and spring)	27-8560	Rear number plate fixing bolt washer (plain)	4
50	M20, M21, M33 (rigid)	67-6830	Rear number plate complete	1
50A	M20, M21, M33 (rigid)	2-1462	Rear mudguard upright stay fixing bolt washer (spring)	2
51	M20, M21, M33 (rigid)	2-2395	Rear mudguard upright stay fixing bolt nut	2
51A	M20, M21, M33 (rigid and spring)	21-5102	Rear reflector nut (1955)	1
52	M20, M21, M33 (rigid and spring)	29-541	Rear reflector washer (shakeproof) (1955)	1
52A	M20, M21, M33 (rigid and spring)	67-9069	Rear reflector (1955)	1
53	M20, M21, M33 (rigid)	66-6947	Rear mudguard lifting handle complete (up to 1955)	1
—	M20, M21, M33 (rigid)	66-6949	Rear mudguard lifting handle	1
54	M20, M21, M33 (rigid)	2-49	Rear mudguard lifting stay top bolt nut	2
55	M20, M21, M33 (rigid)	24-3784	Rear mudguard lifting stay top bolt washer (spring)	2
56	M20, M21, M33 (rigid)	15-7563	Rear mudguard lifting stay packing piece	2
57	M20, M21, M33 (rigid)	66-6833	Rear mudguard with fixed fittings	1
58	M20, M21, M33 (rigid and spring)	67-6839	Rear mudguard tail wiring grommet	2
59	M20, M21, M33 (rigid)	2-1354	Rear mudguard bottom bridge bolt	2
60	M20, M21, M33 (rigid)	2-525	Rear mudguard bottom bridge bolt washer	2
61	M20, M21, M33 (rigid)	66-6891	Mudguard bottom stay	2
62	M20, M21, M33 (rigid)	15-447	Rear mudguard bottom bridge bolt nut	2
63	M20, M21, M33 (rigid)	2-51	Toolbox strap bolt nut	2
64	M20, M21, M33 (rigid)	29-541	Toolbox strap bolt washer (shakeproof)	2
65	M20, M21, M33 (rigid)	15-480	Silencer fixing bolt	1
66	M20, M21 (rigid)	66-2865	Silencer complete	1
67	M20, M21, M33 (rigid)	66-2810	Silencer fixing bolt nut	1
68	M20, M21, M33 (rigid)	36-382	Silencer fixing bolt washer (shakeproof)	1
69	M20, M21, M33 (rigid)	35-698	Silencer fixing bolt split pin	1
70	M20, M21, M33 (rigid)	2-2899	Toolbox clip bolt washer (inside box)	1



Plate Ref. Number.	Models.	Part No.	Description.	Number per set.
71	M20, M21, M33 (rigid)	65-9019	Toolbox complete	1
72	M20, M21, M33 (rigid)	15-7161	Toolbox strap bolt	2
73	M20, M21, M33 (rigid)	65-9021	Toolbox strap	1
74	M20, M21, M33 (rigid)	29-541	Rear number plate fixing bolt washer (shakeproof)	4
75	M20, M21, M33 (rigid and spring)	2-204	Rear number plate fixing bolt (up to 1955)	4
76	M20, M21, M33 (rigid)	24-8784	Mudguard lifting stay bolt washer (spring) (right-hand)	1
77	M20, M21, M33 (rigid)	2-49	Mudguard lifting stay bolt nut (right-hand)	1
78	M20, M21, M33 (rigid)	2-923	Mudguard lifting stay bottom stud washer (left-hand)	1
79	M20, M21, M33 (rigid)	2-49	Mudguard lifting stay bottom stud nut (left-hand)	1
—	M20, M21, M33 (rigid)	24-5205	Rear mudguard lifting handle bottom stud (L./H)	1
80	M20, M21, M33 (rigid)	2-370	Rear mudguard lifting stay top bolt washer (plain)	2
81	M20, M21, M33 (rigid)	2-1934	Rear mudguard lifting stay top bolt	2
82	M20, M21, M33 (rigid)	66-6945	Rear mudguard upright stay (offside)	1
—	M20, M21, M33 (rigid)	66-6901	Rear mudguard upright stay (nearside)	1
—	M20, M21, M33 (rigid)	2S-2338	Rear chainguard securing bolt (chainstay end)	1
83	M20, M21, M33 (rigid)	2-51	Rear mudguard backstay clip bolt nut	2
84	M20, M21, M33 (rigid)	2-1462	Rear mudguard backstay clip bolt washer (spring)	2
85	M20, M21, M33 (rigid)	2-930	Rear mudguard backstay clip bolt washer (fibre)	2
86	M20, M21, M33 (rigid)	24-225	Toolbox fixing clip bolt	1
87	M20, M21, M33 (rigid)	2-525	Toolbox fixing clip bolt washer (plain)	1
88	M20, M21, M33 (rigid)	27-9001	Toolbox fixing clip	1
89	M20, M21, M33 (rigid)	2-6537	Toolbox fixing clip bolt distance piece	1
90	M20, M21, M33 (rigid)	2-923	Mudguard lifting stay bolt washer (plain) (right-hand)	1
91	M20, M21, M33 (rigid)	15-480	Mudguard lifting stay bolt (right-hand)	1
—	M20, M21, M33 (rigid)	65-9053	Toolbox lid fixing screw support bush	1
—	M20, M21, M33 (rigid)	65-9153	Toolbox lid fixing screw strap nut	1
92	M20, M21, M33 (rigid)	29-541	Toolbox fixing clip bolt washer (shakeproof)	1
93	M20, M21, M33 (rigid)	2-2395	Toolbox fixing clip bolt nut	1
94	M20, M21, M33 (rigid)	2-51	Toolbox and mudguard fixing bolt nut	1
95	M20, M21, M33 (rigid)	2-1462	Toolbox and mudguard fixing bolt washer (spring)	1
96	M20, M21, M33 (rigid)	2-51	Rear mudguard chainstay bridge clip bolt nut	2
97	M20, M21, M33 (rigid)	2-1462	Rear mudguard chainstay bridge clip bolt washer (spring)	2
98	M20, M21, M33 (rigid)	2-1027	Toolbox lid fixing screw nut	1
99	M20, M21, M33 (rigid and spring)	2-84	Oil tank drain plug	1
100	M20, M21, M33 (rigid and spring)	2-100	Oil tank drain plug washer	1
101	M20, M21, M33 (rigid)	15-7161	Toolbox and mudguard fixing bolt	1
102	M20, M21, M33 (rigid)	24-7385	Rear mudguard chainstay bridge clip	1

Petrol Tank  
Handlebar  
Dual Seat  
Battery Carrier  
and Silencer

Rear Mudguard  
Toolbox  
Chainguards  
Rear Brake  
Control  
and Silencer

Special  
Components  
as supplied to  
Automobile  
Association

Legshields

Tools and  
Sundries

Electrical  
Equipment

Front and Rear  
Safety Bars,  
Safety Bars  
and Legshields

Sidcar  
Chassis

Carrier a  
Pannier



Plate Ref. Number.	Model.	Part No.	Description.	Number per set.
103	M20, M21, M33 (rigid)	27-8560	Rear mudguard chainstay bridge clip bolt washer	2
104	M20, M21, M33 (rigid)	2-204	Rear mudguard chainstay bridge clip bolt	2
105	M20, M21, M33 (rigid and spring)	65-8422	Oil breather pipe connection ferrule	1
106	M20, M21, M33 (rigid and spring)	65-2060	Oil breather pipe connection (rubber)	1
107	M20, M21 (rigid and spring)	65-8419	Oil supply and return pipe nipple (loose)	2
107	M33 (rigid and spring)	65-8419	Oil supply pipe nipple (loose)	1
108	M20, M21 (rigid and spring)	66-8332	Oil pipe nipple nut	2
108	M33 (rigid and spring)	66-8332	Oil supply pipe nipple nut	1
109	M20, M21 (rigid and spring)	65-8422	Oil pipe connection ferrule	2
109	M33 (rigid and spring)	65-8422	Oil supply pipe connection ferrule	1
110	M20, M21 (rigid and spring)	65-2060	Oil pipe connection (rubber)	2
110	M33 (rigid and spring)	65-2060	Oil supply pipe connection (rubber)	1
111	M20, M21 (rigid and spring)	65-8422	Oil pipe connection ferrule	2
111	M33 (rigid and spring)	65-8422	Oil supply pipe connection ferrule	1
112	M20, M21 (rigid and spring)	66-8332	Oil pipe nipple nut	2
112	M33 (rigid and spring)	66-8332	Oil supply pipe nipple nut	1
—	M20, M21 (rigid and spring)	66-8406	Oil supply and return pipe assembly	2
—	M33 (rigid and spring)	66-8406	Oil supply pipe assembly	1
113	M20, M21 (rigid and spring)	66-8402	Oil supply and return pipe (long)	2
113	M33 (rigid and spring)	66-8402	Oil supply pipe (long)	1
114	M33 (rigid and spring)	66-8332	Oil return pipe nipple nut	1
115	M33 (rigid and spring)	66-8411	Oil return pipe only	1
—	M33 (rigid and spring)	66-8410	Oil return pipe assembly complete	1
116	M33 (rigid and spring)	65-8422	Oil return pipe connection ferrule	1
117	M33 (rigid and spring)	65-2060	Oil return pipe connection (rubber)	1
118	M33 (rigid and spring)	65-8422	Oil return pipe connection ferrule	1
119	M33 (rigid and spring)	65-8420	Oil return pipe connection	1
120	M33 (rigid and spring)	65-8424	Oil return pipe nut	1
121	M33 (rigid and spring)	65-8421	Oil return pipe nut washer (fibre)	1
122	M20, M21, M33 (rigid and spring)	65-8422	Oil breather pipe connection ferrule	1
123	M20, M21, M33 (rigid)	29-9132	Toolbox lid fixing screw complete	1
124	M20, M21, M33 (rigid and spring)	2-2395	Oil tank breather pipe clip bolt nut	1
125	M20, M21, M33 (rigid and spring)	66-8340	Oil tank breather pipe clip	1
126	M20, M21, M33 (rigid and spring)	66-8330	Oil tank breather extension pipe	1
127	M20, M21, M33 (rigid and spring)	2-204	Oil tank breather pipe clip bolt	1
128	M20, M21, M33 (rigid)	66-7806	Rear chainguard complete	1



Petrol Tank, Dual Seat Battery Carrier Handlebar  
Silencers "M" Group

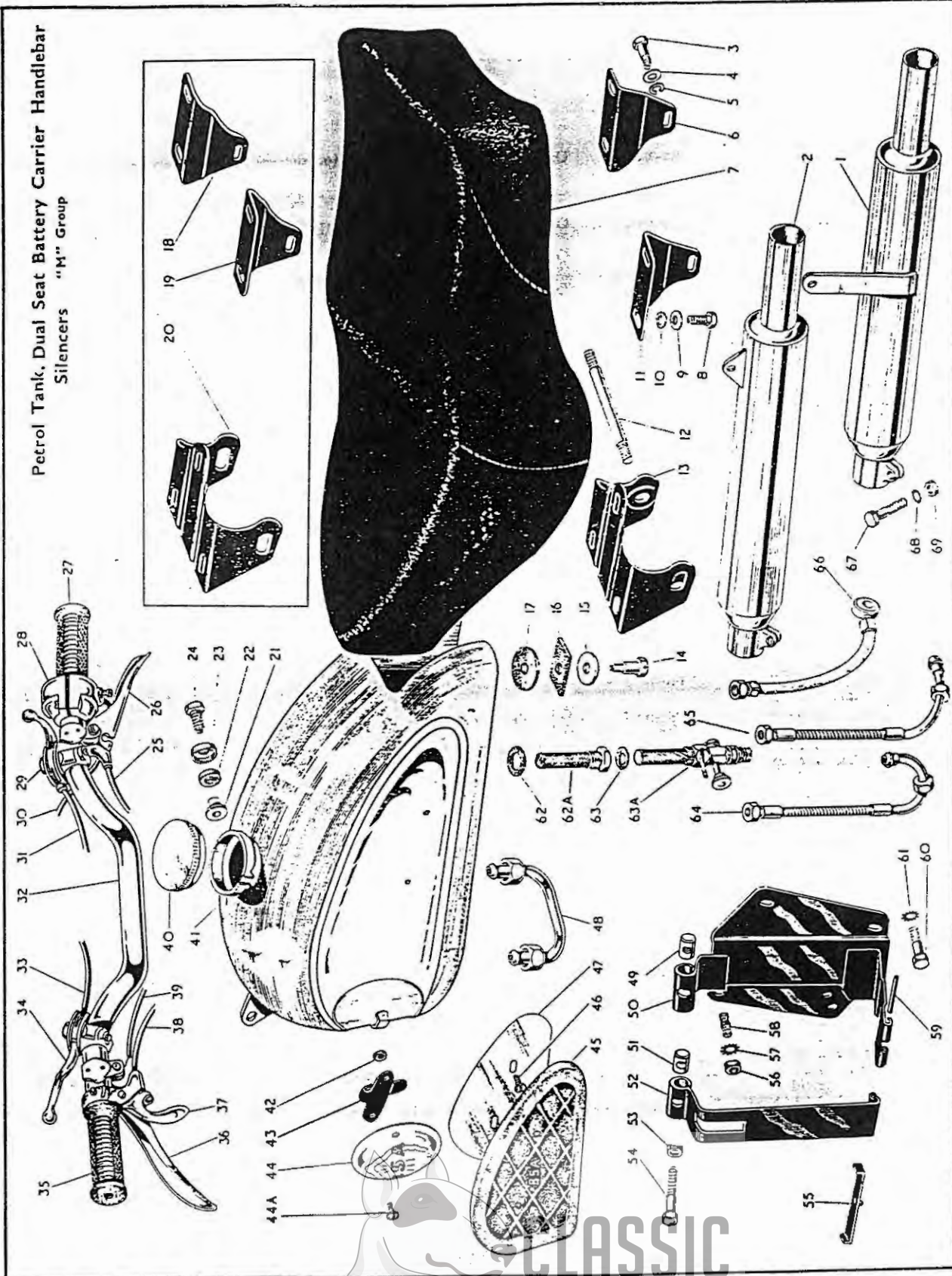

Petrol Tank  
Handlebar  
Dual Seat  
Battery Carrier  
and Silencer

ear Mudguard  
Toolbox  
Chainguards  
Rear Brake  
Control  
and Silencer

Special  
Components  
as supplied to  
Automobile  
Association

Legshields

Tools and  
Sundries

Front and Rear  
Safety Bars,  
Safety Bars  
and Legshields

Sidecar  
Chassis

Carrier  
Pannier

CLASSIC  
BIKE SPARES

Plate 15 Petrol Tank, Handlebar, Dual Seat, Battery Carrier and Silencers  
"M" Group.

Plate Ref. Number.	Model.	Part No.	Description.	Number per set.
1	M33 (rigid)	66-2865	Silencer complete	1
1	M33 (rigid)	66-2991	Silencer complete (1955)	1
2	M33 (spring)	66-2670	Silencer complete	1
3	M20, M21, M33 (rigid and spring)	27-6037	Dual seat to mudguard fixing bolt	2
4	M20, M21, M33 (rigid and spring)	2-923	Dual seat to mudguard fixing bolt washer (plain)	2
5	M20, M21, M33 (rigid and spring)	35-33	Dual seat to mudguard bolt washer (spring)	2
6	M20, M21, M33 (rigid)	67-9094	Dual seat rear support bracket (offside)	1
7	M20, M21, M33 (rigid and spring)	67-9087	Dual seat complete (less fittings)	1
8	M20, M21, M33 (rigid and spring)	2-129	Dual seat fixing bolt...	7
9	M20, M21, M33 (rigid and spring)	2-923	Dual seat fixing bolt washer (plain)	7
10	M20, M21, M33 (rigid and spring)	35-33	Dual seat fixing bolt washer (spring)	7
11	M20, M21, M33 (rigid)	67-9093	Dual seat rear support bracket (nearside)	1
12	M20, M21, M33 (rigid and spring)	67-9095	Backstay and seat lug stud	1
13	M20, M21, M33 (rigid)	66-9244	Dual seat front support bracket	1
—	M20, M21, M33 (rigid and spring)	66-9247	Dual seat complete with fittings	1
—	M20, M21, M33 (rigid and spring)	66-9249	Dual seat fittings only (sets)	1
14	M20, M21, M33 (rigid and spring)	65-8034	Petrol tank rear fixing bolt	2
15	M20, M21, M33 (rigid and spring)	30-660	Petrol tank rear fixing bolt washer (plain)	2
16	M20, M21, M33 (rigid and spring)	65-8032	Petrol tank rear support bolt rubber (bottom)	2
17	M20, M21, M33 (rigid and spring)	66-8091	Petrol tank rear support bolt rubber (top)	2
18	M20, M21, M33 (spring)	67-9093	Dual seat rear support bracket (offside)	1
19	M20, M21, M33 (spring)	67-9094	Dual seat rear support bracket (nearside)	1
20	M20, M21, M33 (spring)	65-9236	Dual seat front support bracket	1
21	M20, M21, M33 (rigid and spring)	27-8447	Petrol tank support sleeve	2
22	M20, M21, M33 (rigid and spring)	27-8448	Petrol tank front support rubber	2
23	M20, M21, M33 (rigid and spring)	27-8449	Petrol tank front support buffer cap	2
24	M20, M21, M33 (rigid and spring)	28-2338	Petrol tank fixing bolt (front)	2
25	M20, M21, M33 (rigid and spring)	65-8675	Front brake cable and cover complete (up to 1955)	1
26	M20, M21, M33 (rigid and spring)	29-8810	Front brake control complete (less cable and cover) (up to 1955)	1
27	M20, M21, M33 (rigid and spring)	65-8503	Twist grip rubber grip	1
28	M20, M21, M33 (rigid and spring)	65-8501	Throttle twist grip complete (less cable and cover)	1
29	M20, M21, M33 (rigid and spring)	66-8896	Air control complete (less cable and cover)	1
29	M20, M21, M33 (rigid and spring)	66-8544	Air control cable and cover complete (Western type handlebars)	1
30	M33 (rigid and spring)	65-8832	Twist grip control cable and cover complete	1
30	M20, M21 (rigid and spring)	66-8882	Twist grip control cable and cover complete	1
31	M33 (rigid and spring)	65-8836	Air control cable and cover complete (up to 1955)	1
31	M33 (rigid and spring)	42-8693	Air control cable and cover complete	1
31	M20, M21 (rigid and spring)	66-8899	Air control cable and cover complete (up to 1955)	1



Plate 15—continued Petrol Tank, Handlebar, Dual Seat, Battery Carrier and Silencers

"M" Group

Plate Ref. Number.	Models.	Part No.	Description.	Number per set.
31	M20, M21 (rigid and spring)	66-8910	Air control cable and cover complete	1
32	M20, M21, M33 (rigid and spring)	65-4960	Handlebar (less controls)	1
33	M20, M21, M33 (rigid and spring)	65-8714	Ignition control cable and cover complete	1
34	M20, M21, M33 (rigid and spring)	66-8810	Ignition control lever complete (less cable and cover)	1
35	M20, M21, M33 (rigid and spring)	65-8502	Rubber grip (for left-hand bar)	1
36	M20, M21, M33 (rigid and spring)	29-8820	Clutch control complete (less cable and cover)	1
37	M20, M21, M33 (rigid and spring)	66-8513	Exhaust control complete (less cable and cover)	1
38	M20, M21 (rigid and spring)	66-8530	Exhaust lifter cable and cover complete	1
38	M33 (rigid and spring)	65-8795	Exhaust lifter cable and cover complete	1
39	M20, M21, M33 (rigid and spring)	65-8680	Clutch control cable and cover complete	1
40	M20, M21, M33 (rigid and spring)	29-7898	Petrol tank filler cap	1
41	M20, M21, M33 (rigid and spring)	66-8285/36	Petrol tank (up to 1953)	1
41	M20, M21, M33 (rigid and spring)	66-8283	Petrol tank	1
42	M20, M21, M33 (rigid and spring)	42-8034	Petrol tank badge clip screw nut	4
43	M20, M21, M33 (rigid and spring)	42-8020	Petrol tank badge clip	2
44	M20, M21, M33 (rigid and spring)	65-8220	Petrol tank badge	2
44	M20, M21, M33 (rigid and spring)	65-8209	Petrol tank badge complete with centre (nearside) (up to 1953)	1
—	M20, M21, M33 (rigid and spring)	36-382	Petrol tank rear support bolt washer	2
44	M20, M21, M33 (rigid and spring)	65-8217	Petrol tank badge complete with centre (oilside) (up to 1953)	1
44a	M20, M21, M33 (rigid and spring)	65-8317	Petrol tank badge clip screw	4
45	M20, M21, M33 (rigid and spring)	65-8205	Knee grip rubber (right-hand)	1
45	M20, M21, M33 (rigid and spring)	65-8206	Knee grip rubber (left-hand)	1
46	M20, M21, M33 (rigid and spring)	2-79	Knee grip plate screw	4
47	M20, M21, M33 (rigid and spring)	29-7868	Knee grip plate (left-hand) (up to 1955)	1
47	M20, M21, M33 (rigid and spring)	29-7869	Knee grip plate (right-hand) (up to 1955)	1
48	M20, M21, M33 (rigid and spring)	33-8255	Tank connecting pipe complete	1
49	M20, M21, M33 (rigid and spring)	65-2353	Battery carrier swivel block (tapped)	1
—	M20, M21, M33 (rigid and spring)	66-4892	Battery carrier complete	1
50	M20, M21, M33 (rigid and spring)	66-4893	Battery bracket complete	1
51	M20, M21, M33 (rigid and spring)	65-2352	Battery carrier swivel block (plain)	1
52	M20, M21, M33 (rigid and spring)	29-4657	Battery carrier strap	1
53	M20, M21, M33 (rigid and spring)	29-4662	Battery strap bolt saddle washer	1
54	M20, M21, M33 (rigid and spring)	29-4661	Battery strap bolt	1
55	M20, M21, M33 (rigid and spring)	29-4665	Battery locating strip complete	1
56	M20, M21, M33 (rigid and spring)	24-563	Battery bracket and frame stud nut	2
57	M20, M21, M33 (rigid and spring)	36-382	Battery bracket and frame stud washer (shakeproof)	5
58	M20, M21, M33 (rigid and spring)	65-5327	Battery bracket and frame stud	2

ear Mudguard  
Toolbox  
Chainguards  
Rear Brake  
Control  
and Silencer

Special  
Components  
as supplied to  
Automobile  
Association

Legshields

Tools and  
Sundries

Electrical  
Equipment

Front and Rear  
Safety Bars,  
Safety Bars  
and Legshields

Sidecar  
Chassis

Carrier  
Pannier

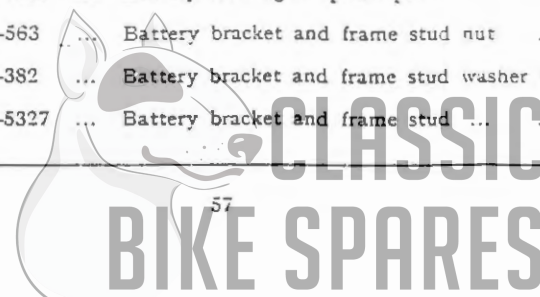

Plate 16 Rear Mudguard, Toolbox, Chainguard, Rear Brake Control and Silencer  
 "M" Group (Spring Frame)

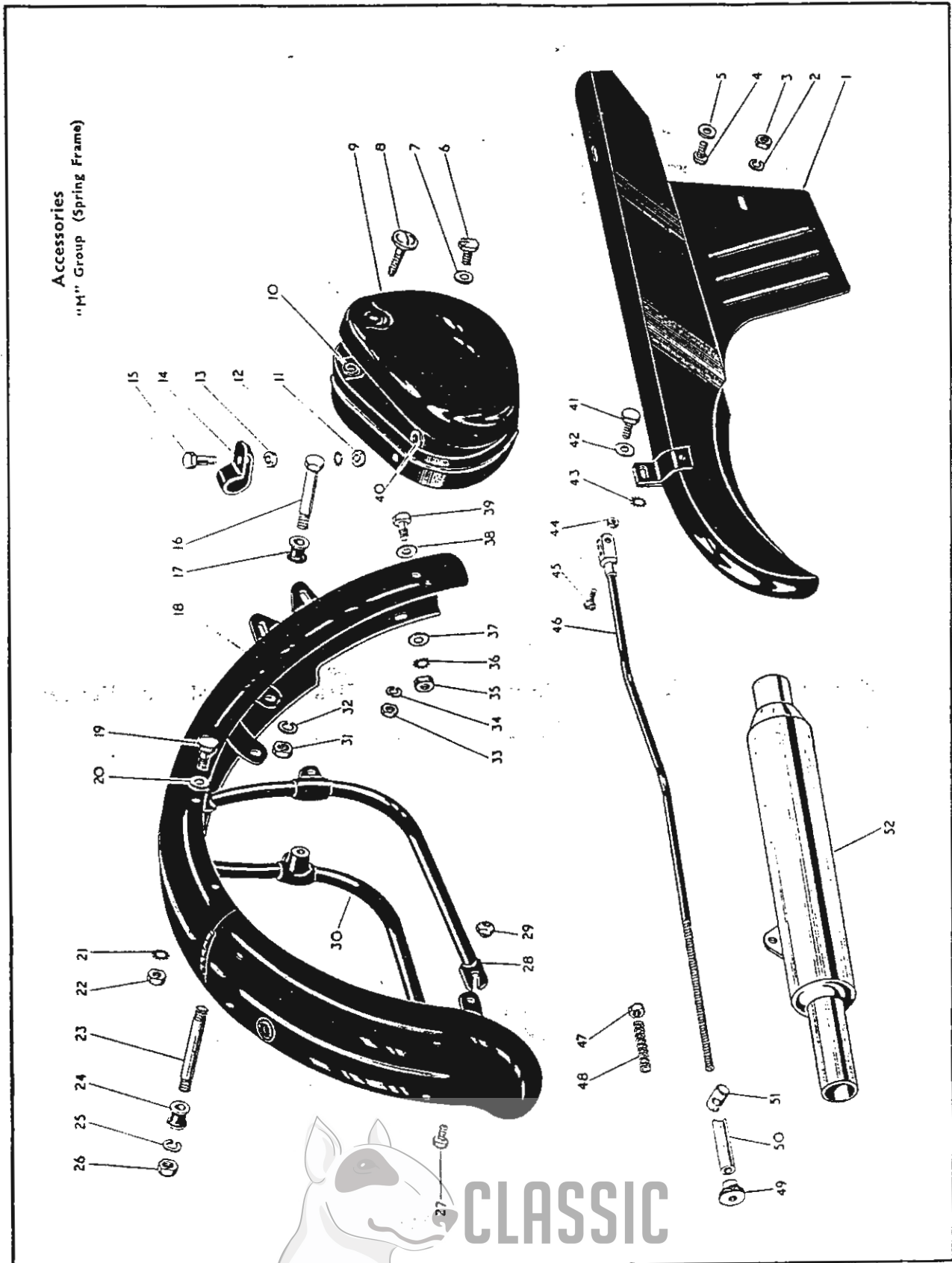



Plate 15—continued Petrol Tank, Handlebar, Dual Seat, Battery Carrier and Silencers  
"M" Group.

Plate Ref. Number.	Model.	Part No.	Description.	Number per set.
59	M20, M21, M33 (rigid and spring)	29-4664	Battery carrier strap hinge pin	1
60	M20, M21, M33 (rigid and spring)	2-6026	Battery bracket and oil tank fixing bolt	3
61	M20, M21, M33 (rigid and spring)	36-382	Battery bracket and oil tank fixing bolt washer (shakeproof)	3
62	M20, M21, M33 (rigid and spring)	24-8504	Petrol filter washer (fibre) (.078")	as reqd.
62	M20, M21, M33 (rigid and spring)	65-8218	Petrol tap washer (fibre) (1/16")	as reqd.
62	M20, M21, M33 (rigid and spring)	65-8219	Petrol tap washer (fibre) (3/32")	as reqd.
62A	M20, M21, M33 (rigid and spring)	27-8443	Petrol filter complete (up to 1953)	1
63	M20, M21, M33 (rigid and spring)	2-930	Petrol tap washer (fibre) (up to 1953)	2
63A	M20, M21, M33 (rigid and spring)	27-8553	Petrol tap (up to 1953)	1
63A	M20, M21, M33 (rigid and spring)	65-8216	Petrol tap	1
64	M33 (rigid and spring)	65-8153	Flexible petrol pipe complete (up to 1954)	1
65	M20, M21, M33 (rigid and spring)	66-8277	Flexible petrol pipe (1954)	1
66	M21, M33 (rigid and spring)	66-8168	Petrol pipe complete (plastic)	1
66	M33 (rigid and spring)	66-8169	Petrol pipe complete (plastic)	1
67	M20, M21, M33 (rigid and spring)	24-7343	Silencer inlet tube clip bolt	1
68	M20, M21, M33 (rigid and spring)	29-541	Silencer inlet tube clip bolt washer (shakeproof)	1
69	M20, M21, M33 (rigid and spring)	2-2395	Silencer inlet tube clip bolt nut	1

Plate 16 Rear Mudguard, Toolbox, Chainguard, Rear Brake Control and Silencer  
"M Group (Spring Frame)

Plate Ref. Number.	Model.	Part No.	Description.	Number per set.
1	M20, M21, M33 (spring)	65-7720	Rear chainguard complete	1
2	M20, M21, M33 (spring)	2-1462	Chainguard bottom fixing bolt washer (spring)	1
3	M20, M21, M33 (spring)	2-2395	Chainguard bottom fixing bolt nut	1
4	M20, M21, M33 (spring)	15-7161	Chainguard bottom fixing bolt	1
5	M20, M21, M33 (spring)	27-8560	Chainguard bottom fixing bolt washer (plain)	1
6	M20, M21, M33 (spring)	65-7713	Toolbox and mudguard fixing bolt	1
7	M20, M21, M33 (spring)	2-1374	Toolbox and mudguard fixing bolt washer (plain)	2
8	M20, M21, M33 (spring)	29-9132	Toolbox lid fixing screw complete	1
9	M20, M21, M33 (spring)	66-9102	Toolbox complete	1
10	M20, M21, M33 (spring)	2-1027	Toolbox lid fixing screw nut	1
—	M20, M21, M33 (spring)	65-9053	Toolbox lid fixing screw support bush	1
11	M20, M21, M23 (spring)	2-2395	Toolbox fixing clip bolt nut	1
12	M20, M21, M33 (spring)	29-541	Toolbox fixing clip bolt washer (shakeproof)	2

Rear Mudguard  
Toolbox  
Chainguards  
Rear Brake  
Control  
and Silencer

Special  
Components  
as supplied to  
Automobile  
Association

Legshields

Tools and  
Sundries

Electrical  
Equipment

Front and Rear  
Safety Bars,  
Safety Bars  
and Legshields

Sidecar  
Chassis

Carrier  
Pannier



Plate Ref. Number.	Models.	Part No.	Description.	Number per set.
13	M20, M21, M33 (spring)	15-7563	Toolbox fixing clip bolt distance washer	1
14	M20, M21, M33 (spring)	24-8928	Toolbox fixing clip	1
15	M20, M21, M33 (spring)	2-1402	Toolbox fixing clip bolt	1
16	M20, M21, M33 (spring)	67-4030	Mudguard fixing bolt (offside) (seatstay)	1
—	M20, M21, M33 (spring)	2-2899	Toolbox clip bolt washer (plain)	1
17	M20, M21, M33 (spring)	67-6761	Mudguard fixing bolt spacing washer (offside)	1
18	M20, M21, M33 (spring)	66-6831	Rear mudguard with fixed fittings	1
19	M20, M21, M33 (spring)	24-6770	Rear mudguard support bolt	2
20	M20, M21, M33 (spring)	2-923	Rear mudguard support bolt washer (plain)	2
21	M20, M21, M33 (spring)	36-382	Rear mudguard support bolt washer (shakeproof)	2
22	M20, M21, M33 (spring)	2-49	Rear mudguard support bolt nut	2
23	M20, M21, M33 (spring)	27-5684	Mudguard fixing stud (seatstay) (nearside)	1
24	M20, M21, M33 (spring)	67-6761	Mudguard fixing stud spacing washer (nearside)	2
25	M20, M21, M33 (spring)	2-522	Mudguard fixing stud washer (spring) (nearside)	1
26	M20, M21, M33 (spring)	2-449	Mudguard fixing stud nut (nearside)	2
27	M20, M21, M33 (spring)	2-1354	Rear mudguard support bolt (bottom)	2
28	M20, M21, M33 (spring)	66-6858	Rear mudguard support complete (offside)	1
29	M20, M21, M33 (spring)	15-447	Rear mudguard support bolt nut (bottom)	2
30	M20, M21, M33 (spring)	66-6856	Rear mudguard support complete (nearside)	1
31	M20, M21, M33 (spring)	2-449	Mudguard fixing bolt nut (offside)	1
32	M20, M21, M33 (spring)	2-522	Mudguard fixing bolt washer (spring) (offside)	1
33	M20, M21, M33 (spring)	2-2395	Toolbox and mudguard fixing bolt nut	1
34	M20, M21, M33 (spring)	2-1462	Toolbox and mudguard fixing bolt washer (spring)	1
35	M20, M21, M33 (spring)	2-49	Mudguard chainstay bridge bolt nut	1
36	M20, M21, M33 (spring)	36-382	Mudguard chainstay bridge bolt washer (shakeproof)	1
37	M20, M21, M33 (spring)	2-923	Mudguard chainstay bridge bolt washer (plain)...	1
38	M20, M21, M33 (spring)	2-923	Mudguard chainstay bridge bolt washer (plain)...	1
39	M20, M21, M33 (spring)	24-6770	Mudguard chainstay bridge bolt	1
40	M20, M21, M33 (spring)	25-7180	Toolbox clip bolt washer (plain) (inside box)	1
41	M20, M21, M33 (spring)	1-5069	Chainguard fixing bolt (rear)	1
42	M20, M21, M33 (spring)	2-923	Chainguard fixing bolt washer (plain) (rear)	1
43	M20, M21, M33 (spring)	36-382	Chainguard fixing bolt washer (shakeproof) (rear)	1
44	M20, M21, M33 (spring)	2-443	Rear brake rod toggle screw nut	1
45	M20, M21, M33 (spring)	2-510	Rear brake rod toggle screw	1
46	M20, M21, M33 (spring)	63-7071	Rear brake rod complete	1
47	M20, M21, M33 (spring)	2-2395	Rear brake rod spring locknut	1



Plate 17 Special Components as supplied to Automobile Association  
Model M21

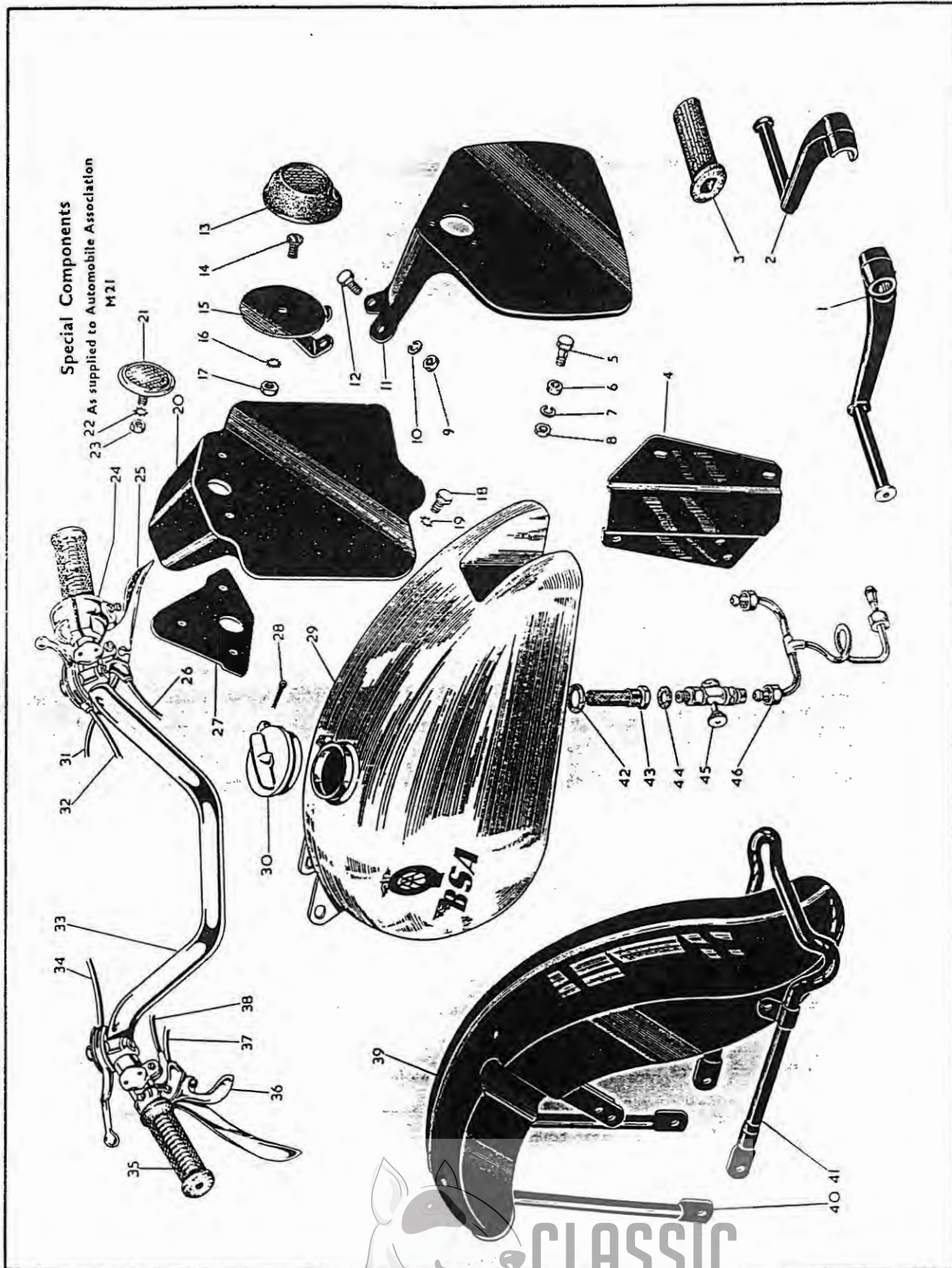

Special Components  
as supplied to Automobile Association  
M21

Special  
Components  
as supplied to  
Automobile  
Association

Legshields

Tools and  
Sundries

Electrical  
Equipment

Front and Rear  
Safety Bars,  
Safety Bars  
and Legshields

Sidecar  
Chassis

Carrier and  
Pannier

CLASSIC  
BIKE SPARES

## Plate 16—continued

Rear Mudguard, Toolbox, Chainguard, Rear Brake Control and Silencer  
"M" Group (Spring Frame)

Plate Ref. Number.	Model.	Part No.	Description.	Number per set.
48	M20, M21, M33 (spring)	15-1312	Rear brake rod spring	1
49	M20, M21, M33 (spring)	29-7368	Rear brake rod adjusting nut	1
50	M20, M21, M33 (spring)	67-7031	Rear brake rod adjusting nut extension tube	1
51	M20, M21, M33 (spring)	65-6274	Rear brake lever swivel pin	1
52	M20, M21 (spring)	66-2670	Silencer complete	1

Plate 17 Special Components as supplied to Automobile Association  
Model M21

Plate Ref. Number.	Model.	Part No.	Description.	Number per set.
1	M21, AA Model	66-7362	Footrest bracket (nearside)	1
2	M21, AA Model	66-7364	Footrest bracket (offside)	1
3	M21, AA Model	66-7363	Footrest rubber	2
4	M21, AA Model	66-4895	Oil tank fixing plate complete	1
5	M21, AA Model	24-225	Rear number plate bottom fixing bolt (1955)	2
6	M21, AA Model	15-7383	Rear number plate bottom bolt fixing bolt washer (rubber) 1955	2
7	M21, AA Model	2-1462	Rear number plate bottom fixing bolt washer (spring) 1955	1
8	M21, AA Model	2-51	Rear number plate bottom fixing bolt nut (1955)	1
9	M21, AA Model	2-51	Rear number plate top fixing bolt nut (1955)	2
10	M21, AA Model	2-1462	Rear number plate top fixing bolt washer (spring) (1955)	2
11	M21, AA Model	66-6897	Rear number plate complete (1955)	1
12	M21, AA Model	2-220	Rear number plate top fixing bolt (1955)	2
13	M21, AA Model	66-6825	Reflector (1955)	1
14	M21, AA Model	1-4606	Reflector fixing screw (1955)	1
15	M21, AA Model	66-6820	Reflector fixing plate complete	1
16	M21, AA Model	29-541	Reflector fixing screw washer (shakeproof)	1
17	M21, AA Model	21-5102	Reflector fixing screw nut	1
18	M21, AA Model	2-220	Rear number plate fixing bolt	4
19	M21, AA Model	29-541	Rear number plate fixing bolt washer (shakeproof)	4
20	M21, AA Model	67-6830	Rear number plate complete...	1
21	M21, AA Model	67-9069	Reflector	1
22	M21, AA Model	29-541	Reflector washer (shakeproof)	1
23	M21, AA Model	21-5102	Reflector nut	1
24	M21, AA Model	65-8512	Throttle twist grip (less cable and cover)	1
25	M21, AA Model	24-7570	Front brake and air control complete (less cable and cover) (1955)	1
26	M21, AA Model	65-8693	Front brake cable and cover complete (1955)	1
27	M21, AA Model	66-6820	Reflector fixing plate	1
28	M21, AA Model	35-707	Petrol tank filler cap split pin	1
29	M21, AA Model	66-8267	Petrol tank	1
30	M21, AA Model	66-8351	Petrol tank filler cap	1
31	M21, AA Model	66-8540	Twist grip control cable and cover complete	1
32	M21, AA Model	66-8537	Air control cable and cover complete	1
33	M21, AA Model	65-4963	Handlebar (less controls)	1
34	M21, AA Model	65-8717	Ignition control cable and cover complete	1
35	M21, AA Model	65-8513	Dummy grip (left handlebar)	1
36	M21, AA Model	42-8610	Exhaust control (less cable and cover)	1
37	M21, AA Model	66-8534	Exhaust lifter cable and cover complete	1
38	M21, AA Model	65-8683	Clutch control cable and cover complete	1
39	M21, AA Model	67-6543	Front mudguard with fixed fittings	1
40	M21, AA Model	67-6544	Front mudguard stays	1
41	M21, AA Model	67-6530	Front stand complete	1
42	M21, AA Model	24-8504	Petrol filter washer (fibre)	2
43	M21, AA Model	27-8436	Petrol filter complete	2
44	M21, AA Model	2-930	Petrol tap washer (fibre)	2
45	M21, AA Model	27-8552	Petrol tap	2
46	M21, AA Model	66-8272	Petrol pipe complete	1



## Supplementary List for M21 Spring Frame Models

Fitted with Generator Set as supplied to Automobile Association

All parts specified for the Standard M21 Spring Frame model are applicable  
excepting items mentioned in this supplement.

### ENGINE

Part Number	Description	Number per set
66-1833	Flywheel with engine shaft (driveside)	1
66-1834	Engine shaft (driveside)	1
66-1824	Crankcase assembly (driveside and gearside)	1
66-141	Cylinder barrel	1
67-985	Sparking plug suppressor	1
19-2312	Carburettor	1
29-1999	Engine sprocket (16T)	1
66-1835	Engine sprocket distance piece	1
66-1830	Generator housing	1
19-1215	Generator	1
29-2031	Spinner for generator	1
29-925	Generator key	1
29-2023	Generator nut	1
29-2024	Generator nut lockwasher	1
66-1831	Generator stator fixing stud	4
2-1462	Generator stator fixing stud washer (spring)	4
2-2395	Generator stator fixing stud nut	4
66-7620	Chaincase and generator housing fixing bolt	3
24-8784	Chaincase and generator housing fixing bolt washer (spring)	3

### CLUTCH

Part Number	Description	Number per set
42-3175	Clutch housing and sprocket assembly (five plate)	1
66-3826	Clutch sleeve	1
42-3180	Clutch shock absorber unit assembly	1
42-3181	Clutch centre	1
42-3182	Shock absorber retaining plate (inner)	1
42-3183	Retaining plate screw (inner to centre)	4
42-3184	Shock absorber spider	1
42-3185	Drive rubber	4
42-3186	Rebound rubber	4
42-3187	Outer retaining plate	1
42-3183	Retaining plate screw (outer to centre)	4
42-3189	Clutch centre pin	4
42-3199	Clutch centre pin nut	4
66-3827	Mainshaft nut washer	1
66-3828	Mainshaft nut tab washer	1
42-3171	Mainshaft nut	1
42-3192	Driving plate assembly	5
42-3195	Clutch driven plate	6
66-3075	Clutch operating rod	1
42-3173	Clutch pressure plate	1
42-3197	Clutch spring cup	4
42-3198	Clutch spring	4

Legshields

Tools and Sundries

Electrical Equipment

Front and Rear Safety Bars, Safety Bars and Legshields

Sidocar Chassis

Carrier and Panniers

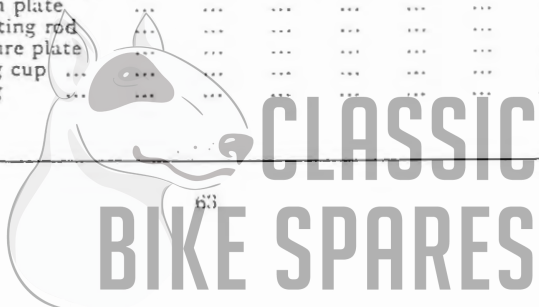

## Supplementary List for M21 Spring Frame Models

Fitted with Generator Set as supplied to Automobile Association

### FRAME AND FITTINGS

Part Number	Description	Number per set
66-4235	Frame complete with engine plates and centre stand	1
66-4237	Chainstay and backstay complete	1
66-4863	Battery carrier complete	1
66-4838	Central stand	1
66-4792	Prop stand lug body	1
66-2876	Silencer	1
66-7364	Footrest bracket (offside) for use with legshields	1
66-7362	Footrest bracket (nearside) for use with legshields	1
66-7363	Footrest rubber	2

### AUXILIARY BATTERY CARRIER

Part Number	Description	Number per set
66-4881	Battery carrier complete	1
29-4624	Battery carrier strap	1
66-4861	Battery carrier fixing spacing washer (top)	1
24-8928	Battery carrier fixing clip (bottom)	2
67-6761	Battery carrier fixing spacer	1
66-4862	Battery carrier bottom fixing bolt (rear)	1
2-129	Battery carrier bottom fixing bolt (front)	1
24-8784	Battery carrier bottom fixing bolt washer (spring)	2
2-49	Battery carrier bottom fixing bolt nut	2

### FRONT FORK AND FITTINGS

Part Number	Description	Number per set
66-5105	Front fork complete	1
65-5447	Front fork top yoke	1
29-5289	Front fork bottom yoke bolt	2
66-5106	Front fork top nut	2
2-84	Fork filler plug	2
2-100	Fork filler plug washer (fibre)	2
65-5449	Fork top yoke plug (rubber)	1
67-5042	Front fork outer sleeve (n/s)	1
67-5044	Front fork outer sleeve (o/s)	1

### FRONT HUB AND WHEEL FITTINGS

Part Number	Description	Number per set
66-5554	Front wheel complete (less brake and tyre)	1
66-5560	Front wheel spoke (nearside)	20
66-5555	Front wheel spoke (offside)	20

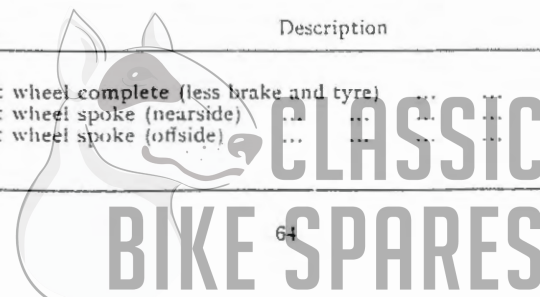



## Supplementary List for M21 Spring Frame Models

Fitted with Generator Set as supplied to Automobile Association

### REAR HUB AND WHEEL FITTINGS

Part Number	Description	Number per set
65-6300	Rear wheel complete (less brake and tyre)	1
65-6303	Rear wheel spoke (nearside)	20
65-6302	Rear wheel spoke (offside)	20

### FRONT CHAINCASE

Part Number	Description	Number per set
66-7613	Chaincase front with fixed fittings	1
66-7616	Chaincase back with sliding plate	1
67-42	Chaincase inspection cap washer	1
29-8111	Chaincase cable grommet	1

### PETROL TANK AND FITTINGS

Part Number	Description	Number per set
66-8267	Petrol tank	1
66-8351	Petrol tank filler cap	1
66-8272	Petrol pipe complete	1
27-8552	Petrol tap	2
2-930	Petrol tap washer (fibre)	2
27-8436	Petrol tank filter complete	2
24-8504	Petrol tank filter washer	2

### HANDLEBAR AND CONTROLS (WESTERN TYPE)

Part Number	Description	Number per set
65-4963	Handlebar	1
66-8537	Air control cable and cover complete	1
66-8540	Throttle control cable and cover complete	1
65-8512	Throttle twist grip	1
65-8514	Throttle twist grip cover	1
65-8513	Dummy grip	1
66-8761	Front brake cable and cover complete	1
65-8683	Clutch control cable and cover complete	1
65-8717	Ignition control cable and cover complete	1
66-8534	Exhaust lifter cable and cover complete	1
42-8610	Exhaust control complete (less cable and cover)	1

Legshields

Tools and Sundries

Electrical Equipment

Front and Rear Safety Bars, Safety Bars and Legshields

Sidecar Chassis

Carrier and Panniers

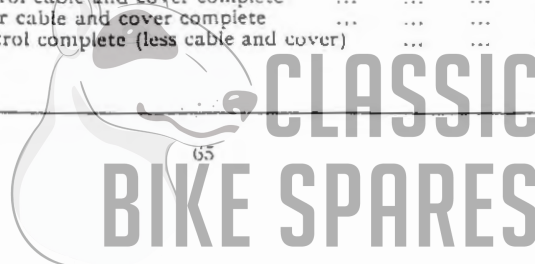

## Supplementary List for M21 Spring Frame Models

Fitted with Generator Set as supplied to Automobile Association

### HANDLEBAR AND CONTROLS (WESTERN TYPE)—*continued*

Part Number	Description	Number per set
24-7570	... Brake and air control complete (less cable and cover) ... ..	1
27-7833	... Brake control ratchet pawl thumb knob spring complete ... ..	1
27-7820	... Brake control lever ... ..	1
27-7819	... Brake control body ... ..	1
27-7818	... Brake control clamp ... ..	1
26-9440	... Brake control lever fulcrum pin ... ..	1
2-1027	... Brake control lever fulcrum pin nut ... ..	2
27-7824	... Air control body ... ..	1
24-7564	... Air control lever ... ..	1
27-7823	... Air control lever spring washer ... ..	1
27-7825	... Air control lever cap ... ..	1
27-7830	... Air control clamp bolt ... ..	1
27-7831	... Air control lever bolt ... ..	1
2-49	... Air control lever bolt nut ... ..	1
2-923	... Air control lever bolt washer (plain) ... ..	1
26-9431	... Cable gripping pin ... ..	1
26-9481	... Control lever roller ... ..	1
26-9461	... Cable gripping pin washer ... ..	1
25-7151	... Cable gripping pin nut ... ..	1

### TOOLS AND SUNDRIES

(No other tools to be supplied)

Part Number	Description	Number per set
66-9132	... Sparking plug spanner ... ..	1
66-9036	... Cylinder base nut spanner ... ..	1
29-9253	... Tommy bar ... ..	1
65-9132	... Tappet adjusting spanner ... ..	1
65-9133	... Tappet adjusting spanner ... ..	1
65-9130	... Tappet feelers (sets) ... ..	1
65-9243	... Front fork top nut spanner ... ..	1
15-832	... Box spanner ... ..	1
66-9234	... Licence holder ... ..	1
...	... Speedometer (non trip 80 m.p.h.) ... ..	1
65-9177	... Speedometer cable ... ..	1
65-9111	... Speedometer bracket ... ..	1
15-7383	... Speedometer mounting rubber ... ..	4
2-1374	... Speedometer mounting bolt washer ... ..	2
21-5620	... Speedometer bracket bolt ... ..	2
66-9262	... Speedometer bracket distance piece ... ..	2
66-9268	... Rectifier bracket ... ..	1

### ELECTRICAL EQUIPMENT

Part Number	Description	Number per set
19-547	... Headlamp (pilot light in reflector) ... ..	1

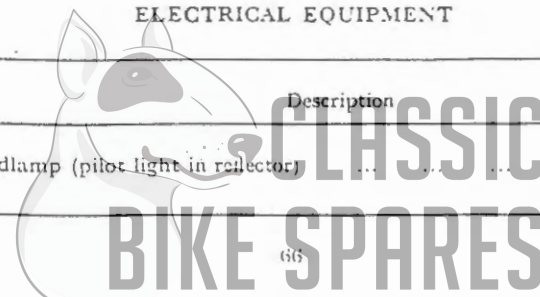



LEGSIELDS  
"M" Group

Legshields  
"M" Group

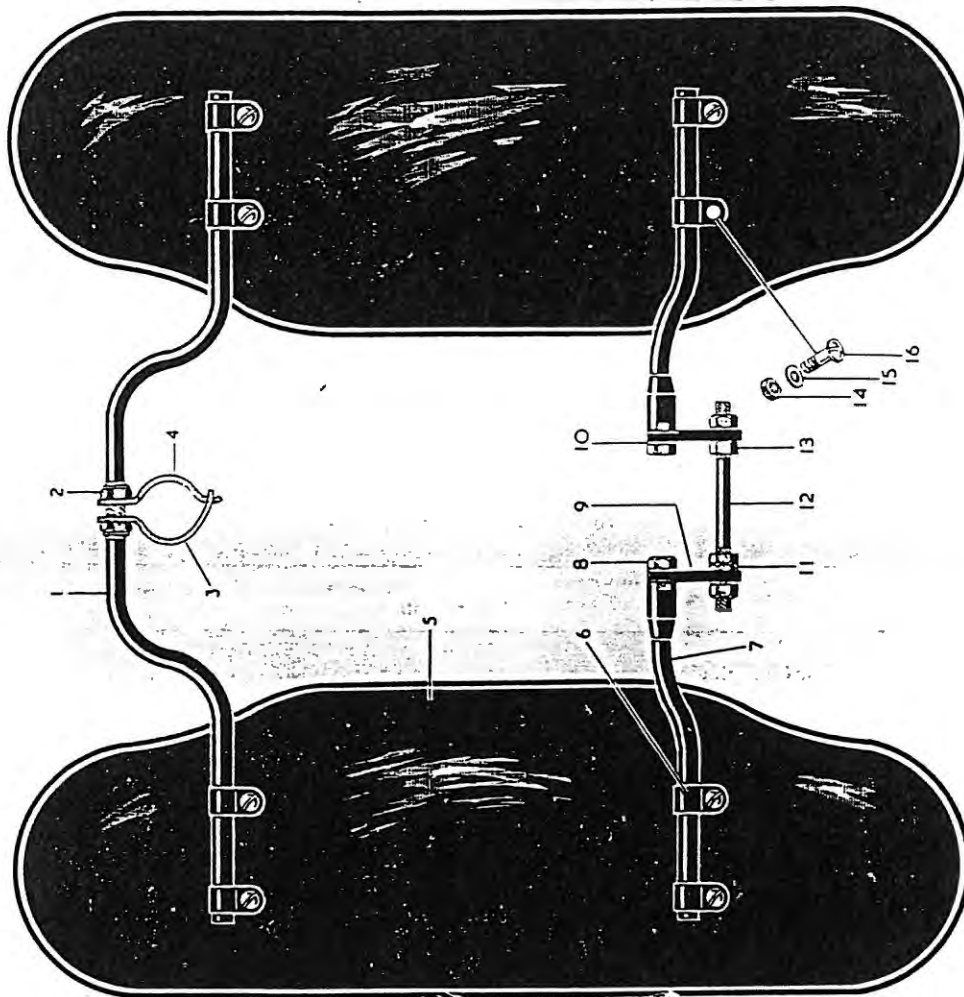

Legshields

Tools and  
Sundries

Electrical  
Equipment

Front and Rear  
Safety Bars,  
Safety Bars  
and Legshields

Sidecar  
Chassis

Carrier &  
Pannier

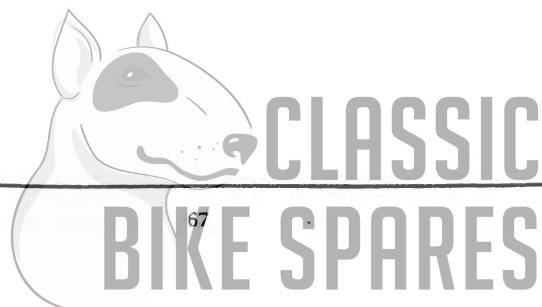

# LEGSHIELDS (Automobile Association)

Legshields  
Automobile Association

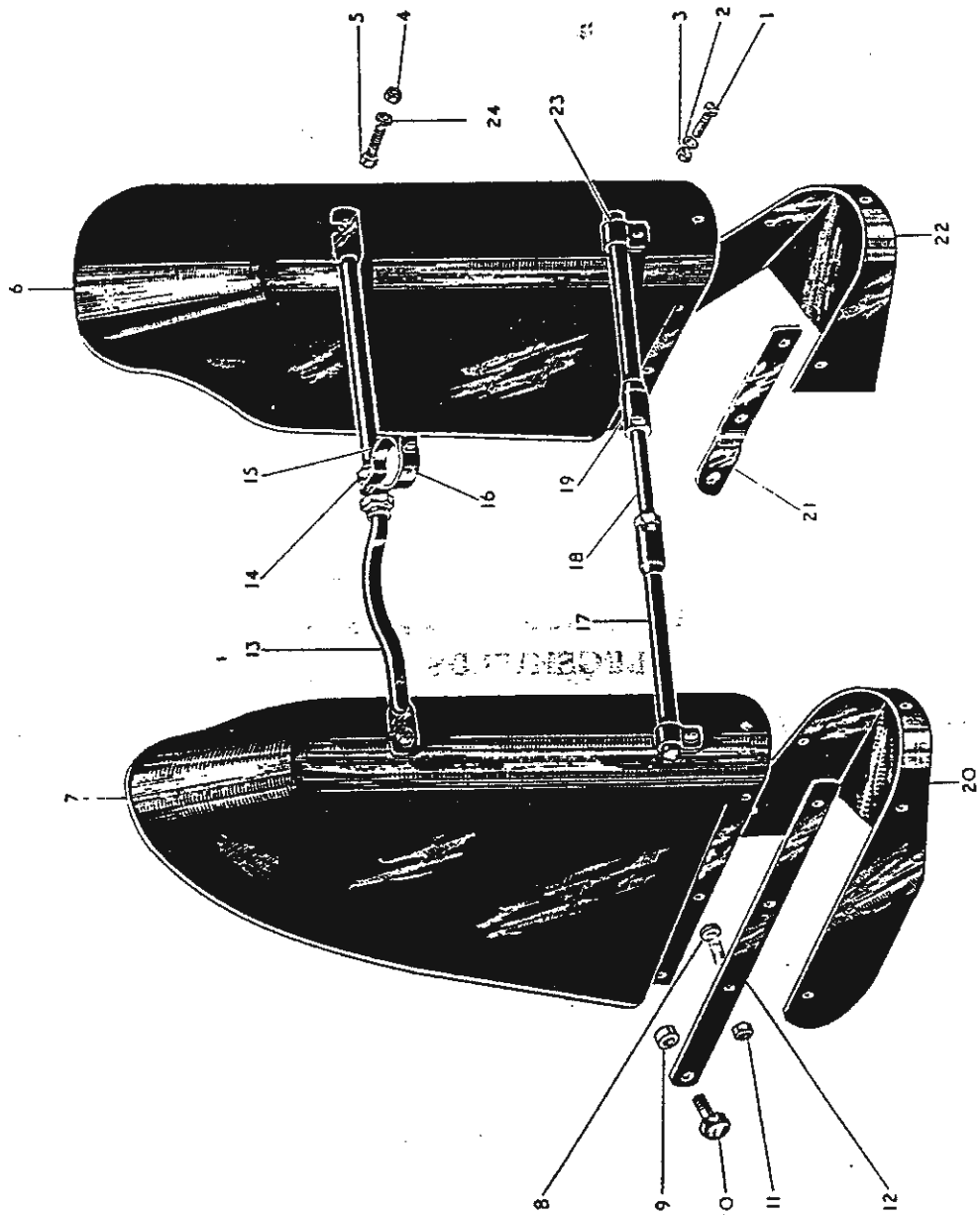



Plate 18

LEGSHIELDS

"M" Group.

Plate Ref. Number.	Model	Part No.	Description.	Number per set.
—	M20, M21, M33 (rigid and spring)	66-7366	Legshield assembly complete	1
1	M20, M21, M33 (rigid and spring)	66-7368	Legshield top support tube complete	1
2	M20, M21, M33 (rigid and spring)	27-7979	Top support tube sleeve nut	2
3	M20, M21, M33 (rigid and spring)	66-7315	Legshield support frame clip (right-hand)	1
4	M20, M21, M33 (rigid and spring)	66-7316	Legshield support frame clip (left-hand)	1
5	M20, M21, M33 (rigid and spring)	66-7367	Legshield only...	2
6	M20, M21, M33 (rigid and spring)	66-7353	Legshield support tube clip	8
7	M20, M21, M33 (rigid and spring)	66-7370	Legshield bottom support tube complete	2
8	M20, M21, M33 (rigid and spring)	29-6110	Legshield bottom support plate bolt	2
9	M20, M21, M33 (rigid and spring)	66-7373	Legshield bottom support plate	2
10	M20, M21, M33 (rigid and spring)	2-2903	Legshield bottom support bolt and stud washer (spring)	4
11	M20, M21, M33 (rigid and spring)	2-452	Engine plate and crankcase stud locknut	1
12	M20, M21, M33 (rigid and spring)	66-7372	Engine plate and crankcase stud	1
13	M20, M21, M33 (rigid and spring)	2-46	Legshield bottom support stud nut	4
14	M20, M21, M33 (rigid and spring)	2-2395	Legshield top and bottom support tube clip screw nut	8
15	M20, M21, M33 (rigid and spring)	27-8560	Legshield top and bottom support tube clip screw washer	8
16	M20, M21, M33 (rigid and spring)	15-7161	Legshield top and bottom support tube clip screw	8

Plate 19

LEGSHIELDS

(Automobile Association.)

Plate Ref. Number.	Models.	Part No.	Description.	Number per set.
—	M21	66-7380	Legshield assembly complete	1
1	M21	2-1354	Legshield support tube clip bolt	2
2	M21	2-1374	Legshield support tube clip bolt washer	2
3	M21	2-51	Legshield support tube clip bolt nut	2
4	M21	27-4401	Legshield stay bolt nut	2
5	M21	2-1354	Legshield stay bolt	2
6	M21	66-7347	Legshield only (left-hand)	1
7	M21	66-7348	Legshield only (right-hand)	1
8	M21	2-1309	Legshield inside fixing strap bolt	12
9	M21	15-7563	Legshield and footrest spacing collar	2
10	M21	15-7354	Legshield and footrest fixing bolt	2
11	M21	25-7151	Legshield inside fixing strap nut	12
12	M21	66-7358	Legshield and footrest fixing strap	2
13	M21	66-7387	Legshield top stay complete	1
14	M21	27-7979	Legshield stay sleeve nut	2
15	M21	6-7316	Legshield stay frame clip (left-hand)	1
16	M21	66-7315	Legshield stay frame clip (right-hand)	1
17	M21	66-7389	Legshield bottom support tube complete (right-hand)	1
18	M21	66-4160	Engine plate and crankcase stud	1
19	M21	66-7351	Legshield bottom support tube complete (left-hand)	1
20	M21	66-7384	Legshield anti-splash extension complete (right-hand)	1
21	M21	66-7356	Legshield inside fixing strap	2
22	M21	66-7381	Legshield anti-splash extension complete (left-hand)	1
23	M21	66-7353	Legshield support tube clip	2
24	M21	2-1374	Legshield stay bolt washer	2

Tools and Sundries

Electrical Equipment

Front and Rear Safety Bars, Safety Bars and Legshields

Sidcar Chassis

Carrier and Pannier







TOOLS and SUNDRIES

"M" Group.

Plate Ref. Number.	Model.	Part No.	Description.	Number per set.
—	M20, M21 (rigid)	66-9142	Toolbag complete with tools	1
—	M20, M21 (spring)	66-9265	Toolbag complete with tools	1
—	M33 (rigid and spring)	66-9266	Toolbag complete with tools	1
1	M33	65-9115	Cylinder head bolt spanner	1
2	M20, M21, M33, AA (rigid and spring)	65-9133	Tappet adjusting spanner	1
3	M20, M21, M33 (rigid and spring)	1-3051	Double ended spanner	1
4	M20, M21, M33 (rigid and spring)	90-9024	Cable clip (rubber) (small)	4
5	M20, M21, M33, AA (rigid and spring)	65-9130	Tappet feelers complete	1
6	M20, M21, M33 (rigid and spring)	66-9049	Cable clip (rubber) (large)	8
7	M20, M21, M33, AA (rigid and spring)	65-9132	Tappet spanner	1
8	M20, M21, M33 (rigid)	66-9052	Hub adjusting sleeve spanner	1
9	M20, M21, M33 (rigid and spring)	65-9246	Combined spanner	1
10	M20, M21, M33, AA (rigid and spring)	65-9243	Front fork top nut and gland nut spanner	1
11	AA	66-9234	Licence holder (Automobile Association)	1
12	M20, M21, M33 (rigid and spring)	42-9026	Inflator	1
13	M20, M21, M33	29-9221	Licence holder	1
14	M20, M21, M33 (rigid and spring)	65-9282	Toolbag only	1
15	M20, M21, M33 (rigid and spring)	29-9252	Tyre lever	1
16	M20, M21, M33, AA (rigid and spring)	29-9253	Tommy bar	1
17	M20, M21, M33, AA (rigid)	66-9042	Wheel alignment gauge	1
18	M20, M21, M33, AA (rigid and spring)	66-9036	Cylinder base nut spanner	1
19	M20, M21, M33 (rigid and spring)	29-9257	Box spanner	1
20	M20, M21, M33 (rigid and spring)	65-9266	Box spanner	1
21	M20, M21, M33 (spring)	65-9245	Hub spindle nut spanner	1
22	M20, M21, M33 (rigid)	66-9067	Hub spindle nut spanner	1
23	M21 AA	15-832	Box spanner (small)	1
24	M20, M21, M33 (rigid)	24-8957	Hub spindle nut spanner tommy bar	1
25	M21, M21, M33 (rigid and spring)	29-9251	Magdyno spanner	1
26	M20, M21, M33, AA (rigid and spring)	66-9132	Sparking plug spanner and screwdriver	1
27	M20, M21, M33 (rigid and spring)	29-9254	Combination spanner	1
28	M20, M21, M33 (rigid and spring)	24-8944	Cable clip (Shamrock pattern)	2
29	M20, M21, M33 (rigid and spring)	66-9113	Cable clip	1

Tools and Sundries

Electrical Equipment

Front and Rear Safety Bars, Safety Bars and Legshields

Sidecar Chassis

Carrier and Pannier

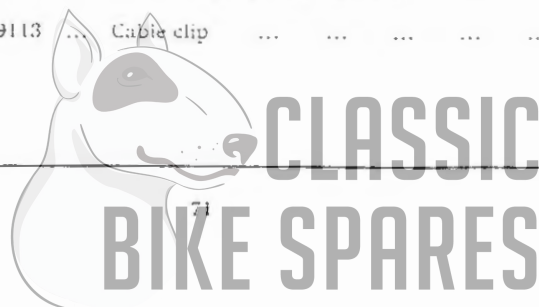

# ELECTRICAL EQUIPMENT

"M" Group

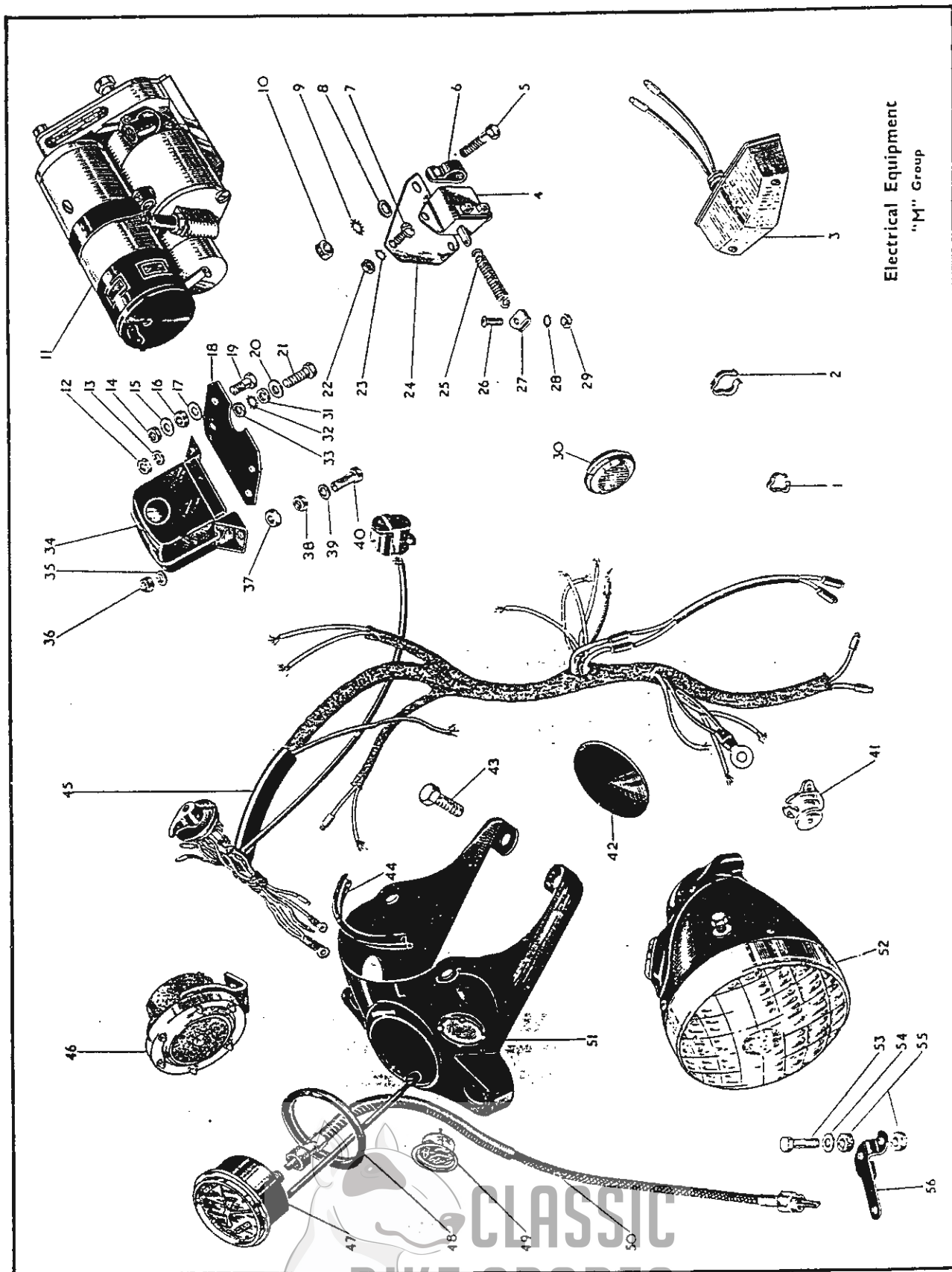

Electrical Equipment  
"M" Group



ELECTRICAL EQUIPMENT

"M" Group

Plate Ref. Number.	Models.	Part No	Description.	Number per set.
1	M20, M21, M33	24-8944	Control cable clip (Shamrock pattern)	2
2	M20, M21, M33	66-9113	Speedometer cable clip	2
3	M20, M21, M33	19-1011	Stop and tail lamp	1
4	M20, M21, M33	19-1106	Stop lamp switch	1
5	M20, M21, M33	28-2338	Switch clip bolt	1
6	M20, M21, M33	24-8928	Stop light switch plate clip...	1
7	M20, M21, M33	2-1309	Switch to plate screw	2
8	M20, M21, M33	2-923	Switch clip bolt washer (plain)	1
9	M20, M21, M33	36-382	Switch clip bolt washer (shakeproof)	1
10	M20, M21, M33	2-49	Switch clip bolt nut	1
11	M20, M21, M33	19-1212	Magdyno	1
12	M20, M21, M33 (rigid)	2-2395	Voltage control mounting bracket bolt nut	2
13	M20, M21, M33 (rigid and spring)	2-1462	Voltage control mounting bracket bolt washer (spring)	2
14	M20, M21, M33 (rigid)	2-2395	Voltage control support bolt nut	2
15	M20, M21, M33 (rigid and spring)	27-8560	Voltage control support bolt washer (plain)	3
16	M20, M21, M33	15-7383	Voltage control support bolt washer (rubber) (up to 1955)	2
17	M20, M21, M33 (rigid)	27-8560	Voltage control support bolt washer (plain)	3
18	M20, M21, M33 (rigid)	66-6816	Voltage control mounting bracket (up to 1955)	1
19	M20, M21, M33 (rigid)	24-225	Voltage control support bolt (up to 1955)	2
20	M20, M21, M33 (rigid)	2-1374	Voltage control mounting bracket bolt washer (plain)	2
21	M20, M21, M33 (rigid)	2-14	Voltage control mounting bracket bolt	2
22	M20, M21, M33	2-47	Switch to plate screw nut	2
23	M20, M21, M33	29-3319	Switch to plate screw washer (shakeproof)	2
24	M20, M21, M33	29-9342	Stop light switch plate	1
25	M20, M21, M33	65-9234	Operating spring	1
25	M20, M21, M33 (spring)	65-9231	Operating spring (up to 1955)	1
26	M20, M21, M33	65-5912	Brake rod clip screw	1
27	M20, M21, M33 (rigid)	66-9173	Brake rod clip	1
27	M20, M21, M33 (spring)	65-9228	Brake rod clip	1
28	M20, M21, M33	29-3319	Brake rod clip washer (shakeproof)	1
29	M20, M21, M33	2-1588	Brake rod clip screw nut	1
30	M20, M21, M33	67-9067	Rear reflector (up to 1954)	1
31	M20, M21, M33 (rigid)	2-6537	Voltage control mounting bracket bolt washer (plain) (up to 1955)	2
32	M20, M21, M33 (rigid)	29-541	Voltage control mounting bracket bolt washer (shakeproof) (up to 1955).	2
33	M20, M21, M33 (rigid)	2-51	Voltage control mounting bracket bolt nut (up to 1955)	2
34	M20, M21, M33	19-1515	Voltage regulator	1
35	M20, M21, M33 (spring)	2-1374	Voltage control support bolt washer (plain)	2
36	M20, M21, M33 (spring)	2-443	Voltage control support bolt nut (up to 1955)	2
37	M20, M21, M33 (spring)	15-7383	Voltage control support bolt washer (rubber) (up to 1955)	2
38	M20, M21, M33 (spring)	2-2395	Voltage control support bolt locknut	2
39	M20, M21, M33 (spring)	2-1374	Voltage control support bolt washer (plain)	2
40	M20, M21, M33 (spring)	2-14	Voltage control support bolt	2
41	M20, M21, M33	19-2012	Electric horn push (up to 1955)	1
—	M20, M21, M33	19-706	Horn push and dipper switch	1
—	M20, M21, M33	19-709	Horn push and dipper switch (Western type handlebars)	1
42	M20, M21, M33	67-5090	Cowl speedometer blanking washer (when speedometer is not fitted)	1
43	M20, M21, M33	65-5435	Front fork bottom yoke bolt	2
44	M20, M21, M33	67-5087	Headlamp cowl rubber extrusion	1

Electrical Equipment

Front and Rear Safety Bars, Safety Bars and Legshields

Sidcar Chassis

Carrier and Pannier



ELECTRICAL EQUIPMENT

"M" Group

Plate Ref. Number.	Models.	Part No.	Description.	Number per set.
45	M20, M21, M33	19-660	Harness with switch and dipper switch (up to 1955)	1
45	M21, M33	19-712	Headlamp switch and cable assembly	1
46	M20, M21, M33 (rigid)	19-2002	Electric horn (up to 1955)	1
46	M20, M21, M33 (rigid)	42-9046	Electric horn	1
46	M20, M21, M33 (spring)	19-2004	Electric horn (up to 1955)	1
46	M21, M33	19-2022	Electric horn	1
47	M20	19-2108	Speedometer (80 m.p.h.) (cowl fitting) (up to 1954)	1
47	M20	19-2118	Speedometer (140 k.p.h.) (cowl fitting) (up to 1954)	1
47	M20	19-2111	Speedometer (120 m.p.h.) (cowl fitting)	1
47	M20	19-2117	Speedometer (180 k.p.h.) (cowl fitting)	1
47	M20	19-2122	Speedometer (180 k.p.h.) (cowl fitting) (1955)	1
47	M21	19-2103	Speedometer (80 m.p.h.) (cowl fitting) (up to 1954)	1
47	M21	19-2117	Speedometer (140 k.p.h.) (cowl fitting) (up to 1954)	1
47	M21	19-2109	Speedometer (120 m.p.h.) (cowl fitting) (1955)	1
47	M21	19-2121	Speedometer (180 k.p.h.) (cowl fitting) (1955)	1
47	M33	19-2109	Speedometer (120 m.p.h.) (cowl fitting)	1
47	M33	19-2121	Speedometer (180 k.p.h.) cowl fitting)	1
48	M20, M21, M33	67-5088	Speedometer mounting rubber (cowl fitting)	1
49	M20, M21, M33	19-649	Ammeter	1
50	M20, M21, M33	29-9341	Speedometer cable	1
50	M21 A.A. Model	66-9177	Speedometer cable	1
51	M20, M21, M33	67-5084	Head lamp cowl	1
52	M20, M21, M33	19-536	Head Lamp	1
52	M21 AA	19-528	Headlamp with pilot light in reflector	1
53	M21 A.A. Model	65-9179	Speedometer mounting bolt (1955)	2
53	M21 AA Model	21-5620	Speedometer bracket bolt	2
—	M21 AA Model	66-9262	Speedometer bracket distance piece	2
54	M21 AA Model	2-1374	Speedometer mounting bolt washer	2
55	M21 AA Model	15-7383	Speedometer mounting rubber	4
56	M21 AA Model	65-9111	Speedometer bracket	2
—	M20, M21, M33	19-1552	Battery	1





# FRONT and REAR SAFETY BARS "M" Group

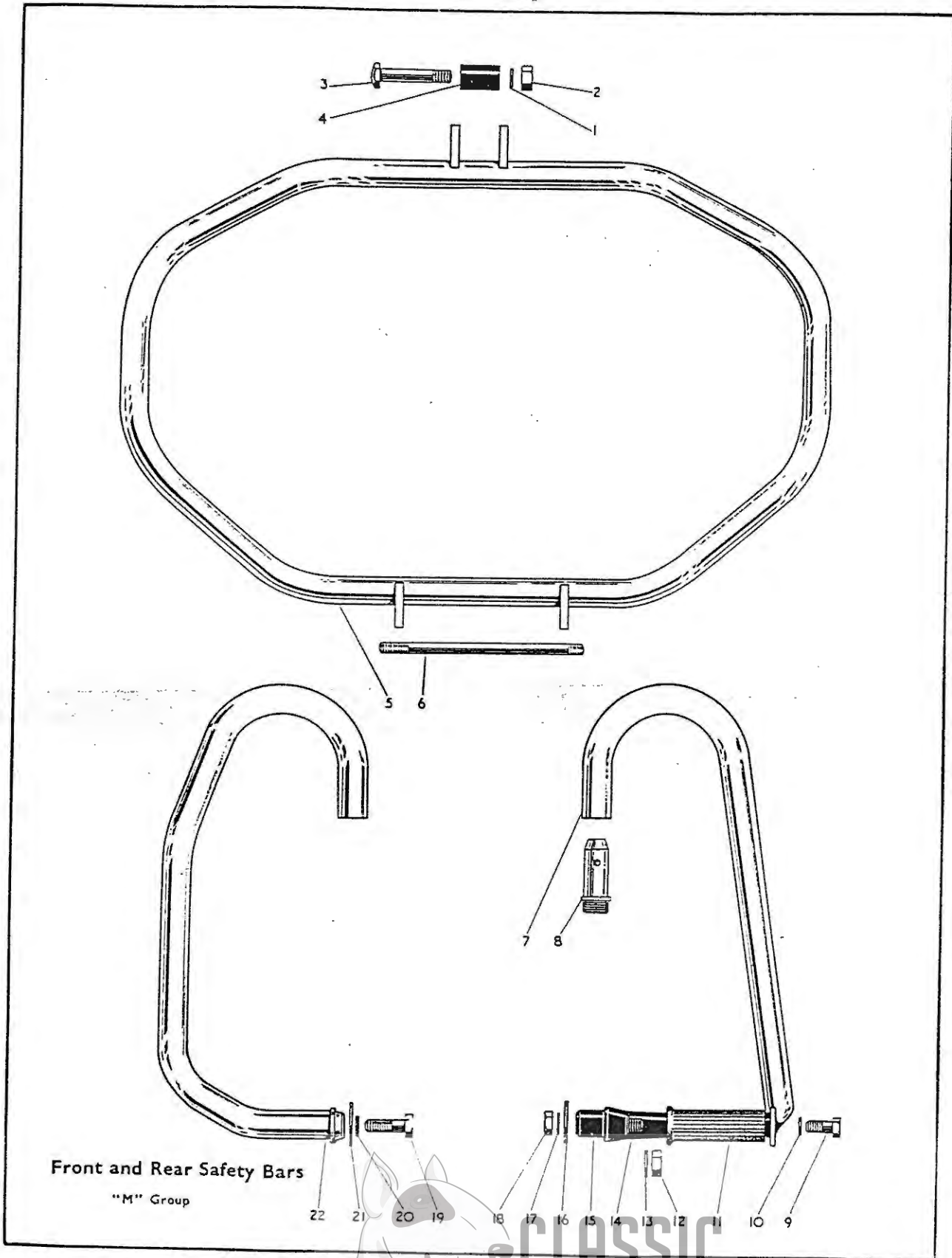

Front and Rear  
Safety Bars,  
Safety Bars  
and Legshields

Sidecar  
Chassis

Carrier and  
Panniers

FRONT and REAR SAFETY BARS

"M" Group (Rigid and Spring)

Plate Ref. Number.	Models.	Part No.	Description.	Number per set.
1	M20, M21, M33 (rigid and spring)	3-110	Front safety bar bolt washer (spring)	1
2	M20, M21, M33 (rigid and spring)	2-1925	Front safety bar bolt nut	1
3	M20, M21, M33 (rigid and spring)	24-5658	Front safety bar bolt	1
4	M20, M21, M33 (rigid and spring)	67-4925	Front safety bar bolt bush	1
5	M20, M21, M33 (rigid and spring)	66-4835	Front safety bar complete	1
6	M20, M21, M33 (rigid and spring)	66-4175	Front engine plate and chainstay stud	1
—	M21, M33 (rigid and spring)	15-541	Front engine plate and chainstay stud nut	2
7	M20, M21, M33 (spring)	67-4932	Rear safety bar complete (nearside) (when pillion footrests are fitted)	1
7	M20, M21, M33 (spring)	67-4926	Rear safety bar complete (offside) (when pillion footrests are fitted)	1
8	M20, M21, M33 (spring)	67-4928	Rear safety bar adaptor (top)	2
9	M20, M21, M33 (spring)	29-6110	Rear safety bar and pillion footrest bolt (when pillion footrests are fitted)	2
10	M20, M21, M33 (spring)	2-2138	Rear safety bar and pillion footrest bolt washer (when pillion footrests are fitted)	2
11	M20, M21, M33 (spring)	66-7363	Pillion footrest rubber	2
12	M20, M21, M33 (spring)	29-905	Rear safety bar adaptor nut (when pillion footrests are fitted)	2
13	M20, M21, M33 (spring)	24-5914	Rear safety bar adaptor washer (when pillion footrests are fitted)	2
14	M20, M21, M33 (spring)	67-4873	Pillion footrest	2
15	M20, M21, M33 (spring)	67-4875	Pillion footrest adaptor (bottom)	2
16	M20, M21, M33 (spring)	30-659	Rear safety bar and pillion footrest washer (large) (when pillion footrests are fitted)	2
17	M20, M21, M33 (spring)	66-4708	Rear safety bar and pillion footrest washer (shakeproof) (when pillion footrests are fitted)	2
18	M20, M21, M33 (spring)	31-7275	Rear safety bar and pillion footrest bolt (when pillion footrests are fitted)	2
19	M20, M21, M33 (spring)	3-1271	Rear safety bar bolt (when pillion footrests not fitted)	2
20	M20, M21, M33 (spring)	66-4708	Rear safety bar bolt washer (shakeproof) (when pillion footrests not fitted)	2
21	M20, M21, M33 (spring)	30-659	Rear safety bar bolt washer (large) (when pillion footrests not fitted)	2
22	M20, M21, M33 (spring)	66-4822	Rear safety bar complete (offside) (when pillion footrests not fitted)	1
22	M20, M21, M33 (spring)	66-4823	Rear safety bar complete (nearside) (when pillion footrests not fitted)	1
—	M20, M21, M33 (spring)	66-4832	Rear safety bar complete assembly	1

CARBURETTER and SETTINGS—1949 to 1957

	1949 to 1954			1955/6/7		
	M20	M21	M33	M20	M21	M33
Carburetter (type)	276C/1B	276BR/1B	289G/1AT	376/21	376/23	376/10
Choke size (inches)	1	1-1/16	1-1/8	1	1-1/16	1-1/16
Jet number	170	160	200	240	250	260
Pilot jet	—	—	—	30	30	25
Throttle Valve number	6/4	6/4	29/4	376/5	376/5	376/3½
Needle position	2	2	3	3	2	3
Needle jet	.1065	.1065	.1065	.1065	.1065	.1065
Engine end size (inches)	1	1-1/16	1-1/8	1	1-1/16	1-1/16

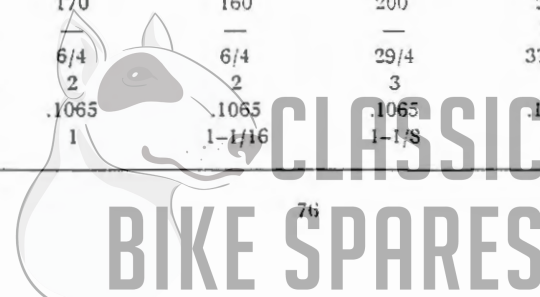



# SAFETY BARS and LEGSHIELDS

"M" Group (Rigid and Spring)

Safety Bars  
and Legshields

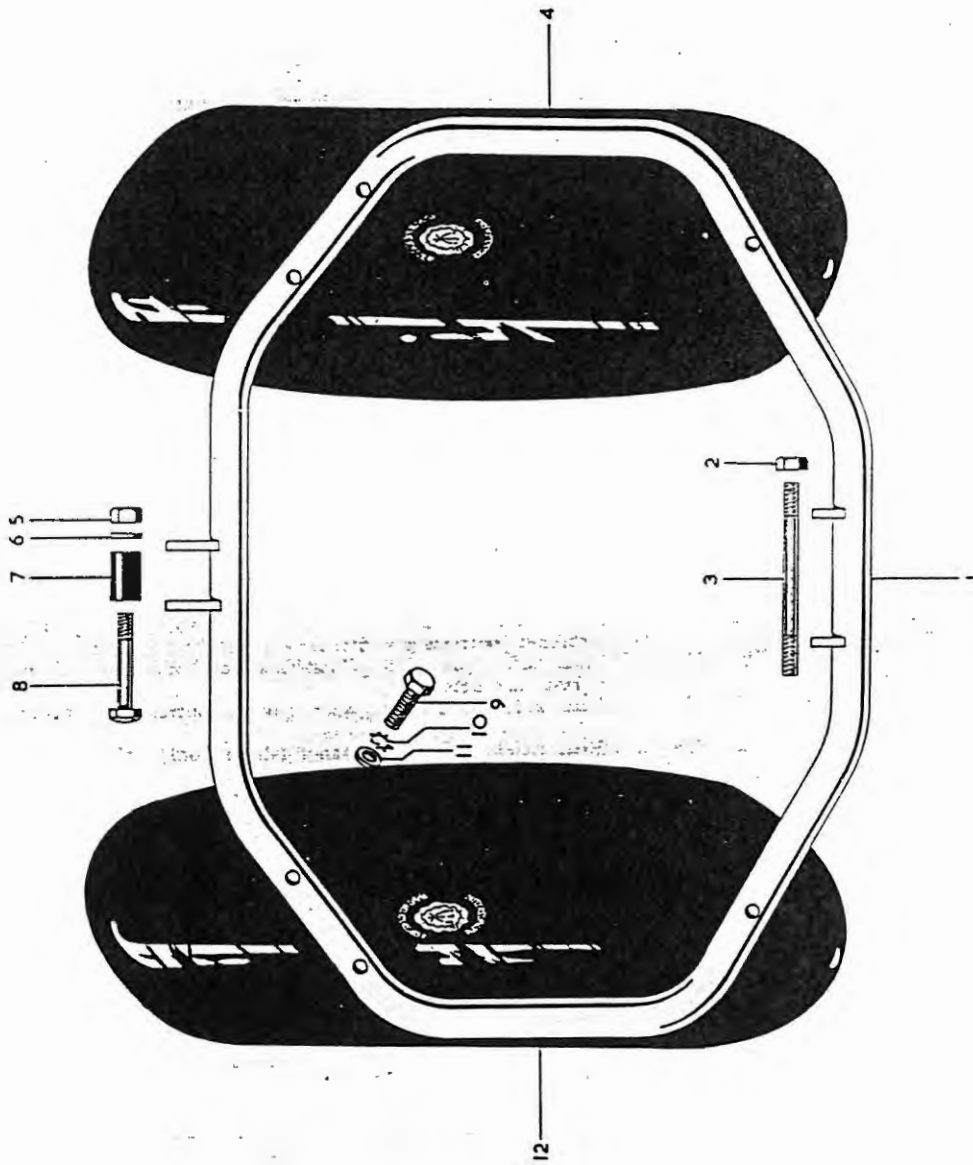

Sidecar  
Chassis

Carrier and  
Panniers

**SAFETY BARS and LEGSHIELDS**

"M" Group (Rigid and Spring)

Plate Ref. Number.	Model.	Part No.	Description.	Number per set.
1	M Group	66-4816	Front safety bar complete	1
2	M Group	15-541	Front engine plate and chainstay bolt nut	2
3	M Group	66-4175	Front engine plate and chainstay stud	1
4	M Group	66-7392	Legshield (nearside)	1
5	M Group	2-1925	Front safety bar bolt nut	1
6	M Group	3-110	Front safety bar bolt spring washer	1
7	M Group	67-4925	Front safety bar bush	1
8	M Group	24-5658	Front safety bar bolt	1
9	M Group	2-1354	Legshield fixing bolts	6
10	M Group	29-541	Legshield fixing bolt washer (shakeproof)	6
11	M Group	25-7180	Legshield fixing bolt washer (plain)	6
12	M Group	66-7393	Legshield (offside)	1

**SIDECAR CHASSIS**

No. 22 and No. 23.

Plate Ref. Number.	Model.	Part No.	Description.	Number per set.
1	22 and 23	2-47	Reflector fixing screw nut	1
2	22 and 23	29-3319	Reflector fixing screw washer (shakeproof)	1
3	22 and 23	2-1096	Reflector fixing screw washer (plain)	1
4	22 and 23	1-4606	Reflector fixing screw	1
5	22 and 23	66-6825	Reflector	1
6	22 and 23	3-1826	Sidcar lamp rubber mounting	1
7	22 and 23	19-1117	Sidcar lamp (red to rear clear to front)	1
8	22 and 23	2-2395	Reflector mounting bracket nut (M group rigid models)	2
9	22 and 23	2-1462	Reflector mounting bracket washer (spring) (M group rigid models).	2
10	22 and 23	27-8560	Reflector mounting bracket washer (plain) (M group rigid models).	2
11	22 and 23	15-7161	Reflector mounting bracket screw (M group rigid models)	2
12	22 and 23	3-1820	Reflector mounting bracket (M group rigid models)	1
13	22 and 23	3-1828	Mudguard	1
14	22 and 23	1-5945	Mudguard upright rear and front stay screw	6
15	22 and 23	27-8560	Mudguard upright rear and front stay washer (plain)	6
16	22 and 23	2-1462	Mudguard upright rear and front stay washer (spring)	6
17	22 and 23	2-2395	Mudguard upright rear and front stay nut	6
18	22 and 23	2-2899	Mudguard upright stay bolt washer (plain)	2
19	22 and 23	3-101	Mudguard stay fixing packing washer (plain)	2
20	22 and 23	28-2338	Mudguard rear stay bolt	2
21	22 and 23	24-8784	Mudguard upright stay bolt washer (spring)	2
22	22 and 23	2-49	Mudguard upright stay bolt nut	2
23	22 and 23	3-1731	Mudguard stays complete	1
24	22 and 23	3-1795	Mudguard support and spindle nut	1
25	22 and 23	24-4237	Mudguard support and spindle nut washer	1
26	22 and 23	3-1816	Wheel spindle securing nut	1
27	22 and 23	27-8039	Hub spindle bracket washer (plain)	1
28	22 and 23	3-1702	Hub spindle	1
29	22 and 23	3-1241	Hub spindle cone (fixed)	1
30	22 and 23	3-34	Hub spindle cone (adjusting)	1
31	22 and 23	35-705	Hub spindle cone castle nut split pin	1
32	22 and 23	3-103	Hub spindle cone washer (plain)	1
33	22 and 23	3-62	Hub spindle cone castle nut	1
34	22 and 23	3-1685	Hub shell cap	1
35	22 and 23	1-4675	Hub ball bearings (for hub cup small)	14
36	22 and 23	3-37	Hub cup (small)	1
37	22 and 23	3-9077	Hub shell complete with cups	1
38	22 and 23	3-36	Hub cup (large)	1
39	22 and 23	1-4675	Hub ball bearings (for hub cup large)	17
40	22 and 23	28-2080	Hub shell grease nipple	1
41	22 and 23	3-1509	Rear bearer bar castle nut	2
42	22 and 23	35-708	Rear bearer bar castle nut split pin	2
43	22	2-46	Rear bearer bar connecting bolt nut (for use with No. 48 commercial box body).	2

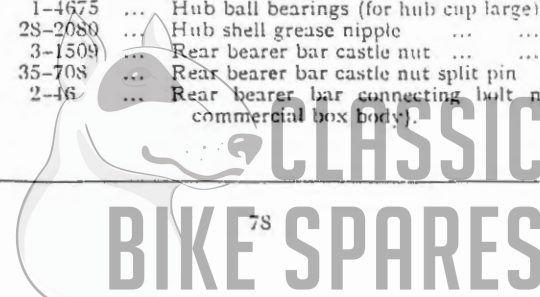



# SIDECAR CHASSIS—continued

No. 22, and No. 23

Plate Ref. Number.	Model.	Part No.	Description.	Number per set.
44 ...	22	3-111	Rear bearer bar connecting bolt washer (spring)	2
45 ...	22	3-1712	Rear bearer bar connecting bolt (for use with No. 48 commercial box body).	2
46 ...	22	65-4185	Rear bearer bar connecting bolt (No. 47 & 51 commercial box body, not used with metal floor).	2
46 ...	22	67-4030	Rear bearer bar connecting bolt (replaces 66-4185 on No. 51 & 54 bodies with metal floor).	2
47 ...	22 and 23	3-1703	Rear bearer bar	1
48 ...	22 and 23	28-2080	Rear spring shackle grease nipple (bottom)	2
49 ...	22 and 23	3-1704	Rear spring shackle complete with bush	2
50 ...	22 and 23	15-5753	Rear spring shackle bolt nut	2
51 ...	22 and 23	3-107	Rear spring shackle bolt washer (spring)	2
52 ...	22 and 23	3-1706	Rear spring shackle bush	2
53 ...	22 and 23	28-2080	Rear spring shackle grease nipple	1
54 ...	22 and 23	3-1746	Rear spring complete with bush	2
55 ...	22 and 23	3-1700	Main rear connection	1
56 ...	22 and 23	28-2080	Main rear connection grease nipple	1
57 ...	22 and 23	3-1383	Rear spring shackle bolt	2
58 ...	22 and 23	30-650	Rear bearer bar connecting bolt clamp washer (plain)	2
59 ...	22 and 23	2-1925	Saddle pillar telescopic lug bolt nut	1
60 ...	22 and 23	3-1709	Axle tube complete	1
61 ...	22 and 23	24-875	Rear bearer bar thrust washer	2
62 ...	22 and 23	2-1945	Rear bearer bar washer (plain)	2
63 ...	22 and 23	2-803	Sidocar stand bolt	1
64 ...	22 and 23	3-1379	Sidocar stand	1
65 ...	22 and 23	2-995	Sidocar stand bolt washer (double spring)	1
66 ...	22 and 23	2-1813	Sidocar stand bolt nut	1
67 ...	22 and 23	35-713	Tube and spindle castle nut split pin	2
68 ...	22 and 23	24-5914	Tube and spindle washer (plain)	2
69 ...	22 and 23	3-953	Tube and spindle castle nut	2
70 ...	22 and 23	3-1701	Wheel bracket	1
71 ...	22 and 23	3-1715	Rear spring plate clamp stud	8
72 ...	22 and 23	3-1289	Saddle pillar telescopic tube lug bolt	1
73 ...	22 and 23	15-716	Saddle pillar telescopic tube bottom lug bolt washer (spring)	1
74 ...	22 and 23	3-1290	Saddle pillar telescopic bottom washer (spherical)	1
75 ...	22 and 23	3-1252	Saddle pillar telescopic tube bottom lug	1
76 ...	22 and 23	3-1271	Saddle pillar tube lug bolt	1
77 ...	22 and 23	3-1714	Rear spring plate	4
78 ...	22 and 23	35-33	Rear spring plate clamp stud washer (spring)	8
79 ...	22 and 23	2-49	Rear spring plate clamp stud nut	8
80 ...	22 and 23	3-111	Saddle pillar tube lug bolt nut	1
81 ...	22 and 23	15-716	Saddle pillar tube lug bolt washer (spring)	1
82 ...	22 and 23	3-1393	Saddle pillar tube lug	1
83 ...	22 and 23	3-107	Saddle pillar connecting bolt washer (spring)	1
84 ...	22 and 23	3-1137	Saddle pillar connecting bolt nut	1
85 ...	22 and 23	30-729	Saddle pillar connecting bolt washer (plain)	1
86 ...	22 and 23	3-619	Saddle pillar tube lug bolt	1
87 ...	22 and 23	3-1724	Saddle pillar tube complete	1
88 ...	22 and 23	3-1258	Saddle pillar telescopic tube lug	1
89 ...	22 and 23	2-1925	Saddle pillar tube lug bolt nut	1
90 ...	22 and 23	3-1603	Saddle pillar telescopic tube complete	1
91 ...	22 and 23	3-619	Front support tube bolt (motor cycle end)	1
92 ...	22 and 23	2-46	Front bottom tube bolt nut (motor cycle end)	1
93 ...	22 and 23	3-1259	Front bottom connection	1
94 ...	22 and 23	2-1925	Front bottom connection bolt nut	1
95 ...	22 and 23	3-1271	Front bottom connection bolt	1
96 ...	22 and 23	3-1728	Front support tube	1
97 ...	22 and 23	3-1369	Front spring bearer bar	1
98 ...	22 and 23	3-345	Front stay cone nut	1
99 ...	22 and 23	3-108	Front stay cone nut washer (spring)	1
100 ...	22 and 23	3-1792	Front stay cone collar (M models 1951)	1
101 ...	22 and 23	3-9274	Front stay complete	1
102 ...	22	30-1605	Front spring bracket bolt (replaces 30-1215 on 51 and 54 bodies with metal floor).	4
102 ...	22	30-1215	Front spring bracket bolt (not used with metal floor)	4
103 ...	22 and 23	3-641	Front spring clamp plate	2
104 ...	22 and 23	3-603	Front spring bracket	2
105 ...	22 and 23	2-49	Front spring connecting bolt nut	4
106 ...	22 and 23	3-861	Front spring	2

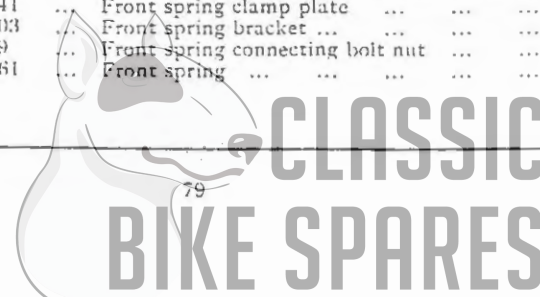

# CLASSIC BIKE SPARES

Sidocar  
Chassis

Carrier and  
Panniers

## SIDECAR CHASSIS—continued

No. 22, and No. 23.

Plate Ref. Number.	Model.	Part No.	Description.	Number per set.
107	22 and 23	3-1372	Front connecting lug bolt	1
108	22 and 23	3-1373	Front connecting lug	1
109	22 and 23	35-33	Front spring bracket bolt washer (spring)	4
110	22 and 23	2-803	Front spring connecting bolt	2
111	22 and 23	3-110	Front connecting lug clip bolt washer (spring)	1
112	22 and 23	3-1271	Front connecting lug clip bolt	1
113	22 and 23	3-839	Front spring cup	2
114	22 and 23	3-111	Front spring connecting bolt washer (spring)	2
115	22 and 23	2-49	Front spring and bearer bar connecting nut	2
116	22 and 23	35-713	Front connecting lug bolt split pin	1
117	22 and 23	3-953	Front connecting lug bolt castle nut	1
118	22 and 23	24-5914	Front connecting lug bolt packing washer (plain)	1
119	22 and 23	27-6974	Mudguard support tube bolt nut	1
120	22 and 23	24-5860	Mudguard support bolt distance nut	1
121	22 and 23	31-7275	Mudguard support tube bolt	1
122	22 and 23	3-9263	Inside strut complete	1
123	22 and 23	3-1741	Mudguard stay support tube complete	1
124	22 and 23	2-49	Support tube lug bolt nut	2
125	22 and 23	35-33	Support tube lug bolt washer (spring)	2
126	22 and 23	3-12	Support tube lug bolt	2
127	22 and 23	3-9264	Outside tie complete	1
128	22 and 23	2-46	Front spring connecting lug stud nut	2
129	23	3-1021	Front spring bracket	2
130	23	3-1080	Front spring (Inner)	2
131	23	3-111	Front connecting lug clip bolt washer (spring)	2
132	23	2-833	Front connecting lug stud washer (plain)	2
133	23	3-1750	Front spring bearer bar	1
134	23	3-1748	Front connecting lug	1
135	22 and 23	67-6005	Wheel rim (WM2-19)	1
136	22 and 23	67-5545	Wheel spoke	40
137	22 and 23	27-6810	Wheel spoke nipple	40
138	22 and 23	2-1946	Sidecar connecting lug stud nut (M rigid)	1
139	22 and 23	3-664	Sidecar connecting lug stud washer (double spring)	1
140	22 and 23	3-663	Connecting lug stud spherical washer	1
141	22 and 23	35-722	Sidecar connecting lug stud nut split pin	1
142	22 and 23	33-4160	Connecting lug stud (M rigid)	1
143	22 and 23	67-4122	Sidecar connecting lug stud nut (Inside) (not required for M group models).	1
144	22 and 23	35-722	Sidecar connecting lug stud nut split pin	1
145	22 and 23	67-4120	Sidecar connecting lug stud (not required for M group models) (lug frame threaded).	1
146	22 and 23	35-722	Sidecar connecting lug stud nut split pin	1
147	22 and 23	3-663	Connecting lug stud spherical washer	1
148	22 and 23	3-664	Sidecar connecting lug stud washer (double spring)	1
149	22 and 23	2-1946	Sidecar connecting lug stud nut (not required for M group models).	1
150	22 and 23	2-1946	Sidecar connecting lug stud nut (M group plunger)	1
151	22 and 23	3-664	Sidecar connecting stud washer (double spring)	1
152	22 and 23	35-722	Sidecar connecting stud split pin	1
153	22 and 23	3-663	Connecting lug stud spherical washer	1
154	22 and 23	67-4181	Sidecar connecting lug stud (M group plunger) (lug frame plain)	1
155	22 and 23	35-722	Sidecar connecting stud split pin	1
156	22 and 23	67-4182	Sidecar connecting lug stud nut (M group plunger)	1
157	22 and 23	19-1118	Sidecar lamp cable (6 foot)	1

## SIDECAR CHASSIS

No. 20A.A.

Plate Ref. Number.	Model.	Part No.	Description.	Number per set.
1	20, AA	3-1795	Hub spindle nut	1
2	20, AA	3-1682	Grease retaining washer cover	1
3	20, AA	3-1681	Grease retaining washer cover inner ring	1
4	20, AA	3-1677	Hub bearing locknut	1
5	20, AA	3-1774	Hub bearing (outer)	1
6	20, AA	3-1676	Hub grease retaining washer (felt)	1
7	20, AA	3-1686	Sidecar hub distance piece	1

90  
**BIKE SPARES**





# SIDECAR CHASSIS—continued

No 20 A.A.

Plate Ref. Number.	Model.	Part No.	Description.	Number per set.
8	20, A.A	27-8039	Hub spindle packing washer	1
9	20, A.A	15-5290	Hub shell grease nipple	1
10	20, A.A	3-1772	Hub shell	1
11	20, A.A	3-1775	Hub bearing adjuster shim (.005") thick	1
11	20, A.A	3-1776	Hub bearing adjuster shim (.010") thick	1
11	20, A.A	3-1777	Hub bearing adjuster shim (.020") thick	1
12	20, A.A	3-1672	Hub bearing spacer	1
13	20, A.A	3-1773	Hub bearing (inner)	1
14	20, A.A	3-1671	Hub spindle	1
15	20, A.A	27-8039	Hub spindle packing washer	1
16	20, A.A	3-1116	Hub spindle castle nut	1
17	20, A.A	35-705	Hub spindle castle nut split pin	1
18	20, A.A	27-8039	Hub spindle packing washer	1
19	20, A.A	3-9152	Mudguard stays complete	1
20	20, A.A	2-47	Reflector fixing screw nut	1
21	20, A.A	29-3319	Reflector fixing screw washer (shakeproof)	1
22	20, A.A	2-1096	Reflector fixing screw washer (plain)	1
23	20, A.A	1-4606	Reflector fixing screw	1
24	20, A.A	66-6825	Reflector	1
25	20, A.A	19-1118	Sidecar lamp cable (6 foot)	1
26	20, A.A	3-1119	Mudguard strengthening plate (rear)	1
27	20, A.A	3-1795	Hub spindle nut complete	1
28	20, A.A	3-1676	Hub grease retaining washer (felt)	1
29	20, A.A	3-1118	Mudguard strengthening plate (front)	1
30	20, A.A	3-1778	Wheel bearing securing ring	1
31	20, A.A	3-1673	Hub grease retaining washer holder	1
32	20, A.A	3-9355	Mudguard upright stay complete (outer)	1
33	20, A.A	3 1688	Hub end cover large (inner)	1
34	20, A.A	3-1117	Mudguard strengthening plate (top)	1
35	20, A.A	2-49	Mudguard upright and rear stay bolt nut	2
36	20, A.A	35-32	Mudguard upright and rear stay washer (spring)	2
37	20, A.A	2-1934	Mudguard upright and rear stay bolt	2
38	20, A.A	30-650	Mudguard upright and rear stay bolt washer (plain)	2
39	20, A.A	3-1120	Front and rear stay bolt	4
40	20, A.A	3-1826	Sidecar lamp mounting (rubber)	1
41	20, A.A	19-1117	Sidecar lamp	1
42	20, A.A	30-988	Mudguard upright stay screw	2
43	20, A.A	3-118	Mudguard upright, front and rear stay bolt washer (plain)	6
44	20, A.A	35-32	Mudguard upright, front and rear stay bolt washer (spring)	6
45	20, A.A	2-51	Mudguard upright, front and rear stay bolt nut	6
46	20, A.A	2-2395	Reflector mounting bracket nut	2
47	20, A.A	2-1462	Reflector mounting bracket washer (spring)	2
48	20, A.A	27-8560	Reflector mounting bracket washer (plain)	4
49	20, A.A	15-7161	Reflector mounting bracket screw	2
50	20, A.A	3-1820	Reflector mounting bracket	1
51	20, A.A	2-46	Stirrup bolt nut	4
52	20, A.A	3-111	Stirrup bolt spring washer	4
53	20, A.A	3-955	Rear spring clamp plate (top)	1
54	20, A.A	3-944	Rear spring shackle distance plate (bottom)	1
55	20, A.A	3-1633	Rear spring with silent bloc	1
56	20, A.A	3-1169	Stirrup bolt	2
57	20, A.A	3-1628	Rear spring silent bloc	2
58	20, A.A	35-705	Rear spring bolt split pin	1
59	20, A.A	3-1253	Rear spring shackle link (plain)	1
60	20, A.A	3-622	Wheel bracket shackle pin bush	1
61	20, A.A	15-1166	Rear spring shackle link nut	1
62	20, A.A	3-1453	Rear spring shackle link complete	1
63	20, A.A	28-2080	Rear spring shackle bolt grease nipple	1
64	20, A.A	3-1099	Mudguard	1
65	20, A.A	2-49	Anti roll spring bolt nut (top)	1
66	20, A.A	24-8784	Anti roll spring washer (top)	2
67	20, A.A	3-101	Anti roll spring top inside washer (plain)	2
68	20, A.A	3-1331	Anti roll spring top washer (top)	2
69	20, A.A	3-1334	Anti roll spring complete with bolts	2
70	20, A.A	24-8784	Anti roll spring washer (bottom)	2
71	20, A.A	2-49	Anti roll spring bolt nut (bottom)	1
72	20, A.A	3-1389	Anti roll spring bracket	1
73	20, A.A	3-1390	Anti roll spring bracket clip	1
74	20, A.A	2-995	Anti roll spring bracket washer (double spring)	2
75	20, A.A	3-1399	Anti roll spring bracket bolt	2
76	20, A.A	2-803	Sidecar stand bolt	1
77	20, A.A	3-1255	Sidecar stand	1

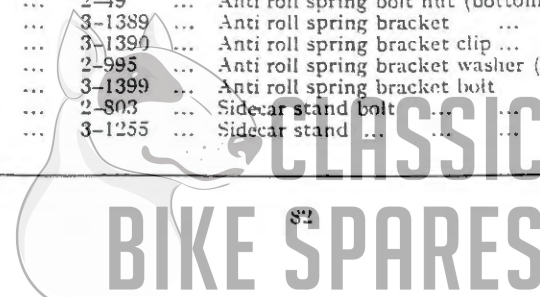



## SIDE CAR CHASSIS—continued

No 20A.A.

Plate Ref. Number.	Model.	Part No.	Description.	Number per set.
78	20, AA	2-995	Sidecar stand bolt spring washer (double spring)	1
79	20, AA	2-1813	Sidecar stand bolt nut	1
80	20, AA	3-953	Front connecting lug bolt castle nut	1
81	20, AA	35-713	Tube end spindle split pin	1
82	20, AA	24-5914	Tube end spindle washer (plain)	2
83	20, AA	3-9227	Axle tube complete	1
84	20, AA	2-1925	Saddle pillar tube lug bolt nut	1
85	20, AA	3-1252	Saddle pillar telescopic tube bottom lug	1
86	20, AA	35-705	Rear spring bolt split pin	1
87	20, AA	3-1455	Rear spring bolt	1
88	20, AA	15-1166	Rear spring bolt castle nut	1
89	20, AA	3-664	Main rear connecting lug stud washer (double spring)	1
90	20, AA	2-1946	Main rear connecting stud nut	1
91	20, AA	3-663	Main rear connecting stud washer (spherical)	1
92	20, AA	2-1925	Saddle pillar telescopic tube bottom lug bolt nut	1
93	20, AA	28-2080	Main rear connection grease nipple	1
94	20, AA	3-1637	Main rear connection	1
94A	20, AA	35-722	Sidecar connecting lug stud nut split pin	1
95	20, AA	3-619	Saddle pillar tube lug bolt	1
95A	20, AA	33-4160	Connecting lug stud	1
96	20, AA	3-1137	Saddle pillar connecting bolt nut	1
97	20, AA	3-107	Saddle pillar connecting bolt washer (spring)	1
98	20, AA	30-729	Saddle pillar connecting bolt washer (plain)	1
99	20, AA	3-1393	Saddle pillar tube lug bolt	1
100	20, AA	3-111	Saddle pillar tube lug bolt washer (spring)	1
101	20, AA	2-46	Saddle pillar tube lug bolt nut	1
102	20, AA	3-1603	Saddle pillar telescopic tube complete	1
103	20, AA	3-1271	Saddle pillar tube lug bolt	1
104	20, AA	3-1258	Saddle pillar telescopic tube lug	1
105	20, AA	35-722	Main rear connection split pin	1
106	20, AA	3-1601	Saddle pillar tube complete	1
107	20, AA	3-1289	Saddle pillar telescopic tube bottom lug bolt	1
108	20, AA	3-110	Saddle pillar telescopic tube bottom lug bolt washer (spring)	1
109	20, AA	3-1290	Saddle pillar telescopic tube spherical washer (bottom)	2
110	20, AA	3-1251	Wheel bracket	1
111	20, AA	27-6813	Wheel spoke nipple	40
112	20, AA	67-6005	Wheel rim	1
113	20, AA	67-5545	Wheel spoke	40
114	20, AA	2-49	Support tube lug bolt nut	1
115	20, AA	35-33	Support tube lug bolt washer (spring)	1
116	20, AA	3-12	Support tube lug bolt	1
117	20, AA	3-1115	Mudguard support tube bolt	1
118	20, AA	2-440	Mudguard support bolt distance nut	1
119	20, AA	3-9344	Mudguard stay support tube complete	1
120	20, AA	3-9264	Outside tie complete	1
121	20, AA	27-6974	Support tube bolt nut	1
122	20, AA	30-729	Front connecting lug bolt packing washer (plain)	1
123	20, AA	3-953	Front connecting lug bolt castle nut	1
124	20, AA	35-713	Front connecting lug bolt split pin	1
125	20, AA	2-46	Front spring connecting bolt nut (bottom)	1
126	20, AA	3-111	Front spring connecting bolt washer (spring)	1
127	20, AA	3-1364	Front spring connecting bolt retaining ring	2
128	20, AA	3-1373	Front connecting lug	1
129	20, AA	3-839	Front spring cup	4
130	20, AA	3-1271	Front connecting lug clip bolt	1
131	20, AA	3-110	Front connecting lug clip bolt washer (spring)	1
132	20, AA	2-46	Front spring connecting bolt nut (top)	1
133	20, AA	3-111	Front spring connecting bolt washer (spring)	2
134	20, AA	30-650	Front spring connecting bolt washer	2
135	20, AA	3-1378	Front spring complete	2
136	20, AA	3-1372	Front connecting lug bolt	1
137	20, AA	3-1369	Front spring bearer bar	1
138	20, AA	3-1605	Front stay complete	1
139	20, AA	3-1792	Front stay cone collar	1
140	20, AA	3-345	Front stay cone nut	1
141	20, AA	3-108	Front stay cone nut washer (spring)	1
142	20, AA	3-619	Front support tube bolt (motor cycle end)	1
143	20, AA	2-46	Front bottom tube nut (motor cycle end)	1
144	20, AA	3-1259	Front bottom connection	1
145	20, AA	3-1271	Front bottom connection bolt	1
146	20, AA	2-1925	Front bottom connection bolt nut	1
147	20, AA	3-1608	Front support tube	1
148	20, AA	3-9263	Inside strut complete	1

CLASSIC  
BIKE SPARES

# SIDECAR CHASSIS

No. 20A.A.

SIDECAR CHASSIS  
No. 20A.A.

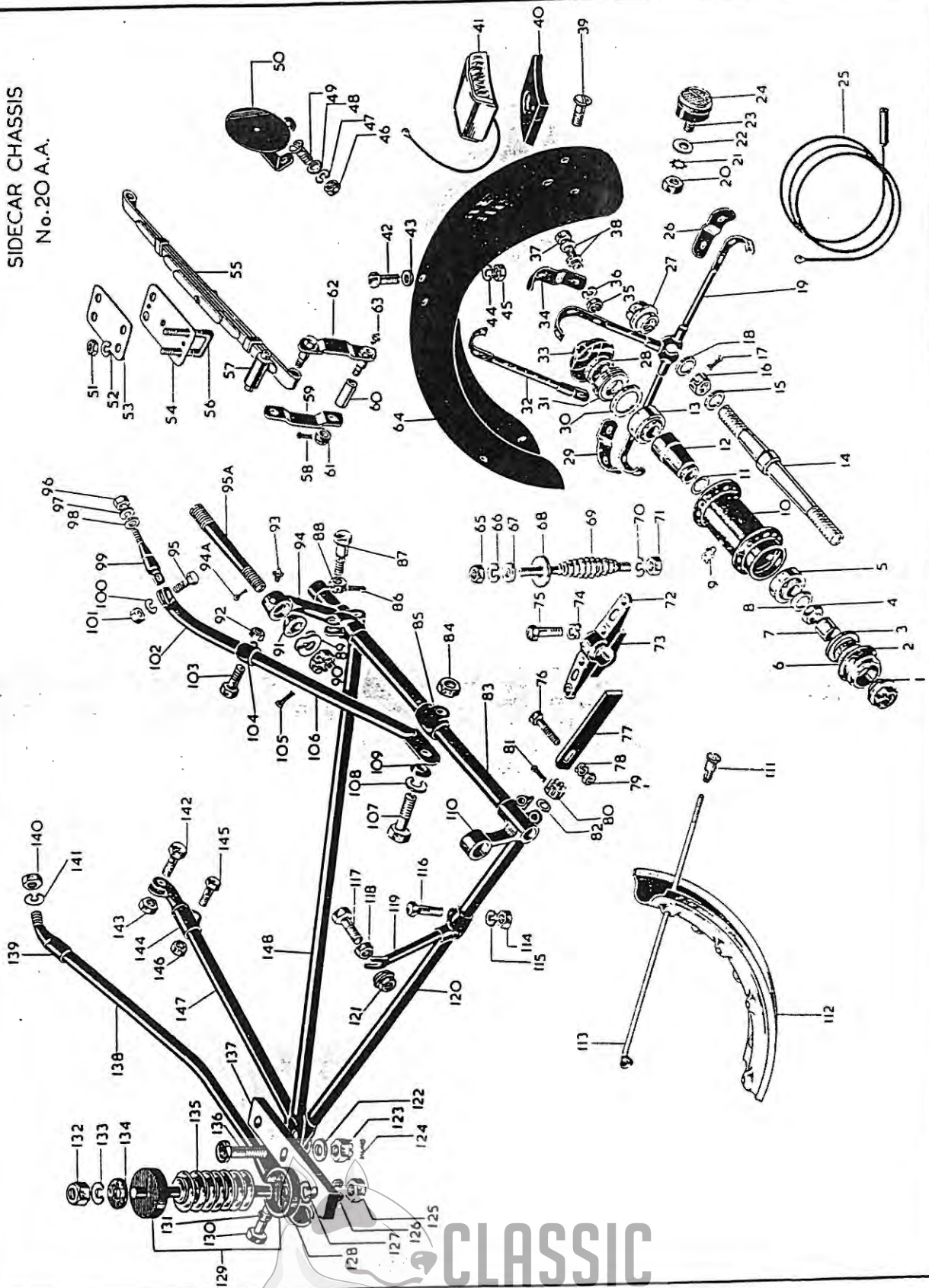

CLASSIC  
BIKE SPARES



## SIDE CAR CHASSIS—*continued*

No 20A.A.

Plate Ref. Number.	Model.	Part No.	Description.	Number per set.
(WHEN OFFICERS' TYPE AND RADIO EQUIPPED BOX IS FITTED)				
— ...	20, AA	... 3-1021 ...	Front spring bracket ...	2
— ...	20, AA	... 3-861 ...	Front spring ...	2
— ...	20, AA	... 3-1080 ...	Front spring (inner) ...	2
— ...	20, AA	... 3-839 ...	Front spring cup ...	2
— ...	20, AA	... 3-641 ...	Front spring clamp plate ...	2
— ...	20, AA	... 2-803 ...	Front spring connection bolt ...	2
— ...	20, AA	... 30-1215 ...	Front spring bracket bolt ...	4
— ...	20, AA	... 35-33 ...	Front spring bracket spring washer ...	4

## CARRIER and PANNIERS

M21, M33 (Spring Frame)

Plate Ref. Number.	Part No.	Description.	Number per set.
1 ...	66-6919	... Pannier bag strap with buckle (short) ...	1
2 ...	66-6916	... Pannier bag with buckle ...	1
3 ...	66-6760	... Carrier complete ...	1
4 ...	2-49	... Carrier and mudguard stud nut ...	2
5 ...	36-382	... Carrier and mudguard stud washer ...	2
6 ...	2-370	... Carrier and mudguard distance washer ...	2
7 ...	65-6794	... Carrier and mudguard support stud ...	2
8 ...	2-923	... Carrier and mudguard fixing bolt washer ...	2
9 ...	1-5069	... Carrier and mudguard fixing bolt ...	2
10 ...	66-6918	... Pannier bag strap less buckle (long) ...	1
11 ...	66-6917	... Pannier bag less buckle ...	1
12 ...	29-541	... Pannier carrier fixing bolt washer ...	4
13 ...	2-2395	... Pannier carrier fixing bolt nut ...	4
14 ...	2-1354	... Pannier carrier fixing bolt ...	4
15 ...	2-2395	... Pannier fixing bolt nut ...	6
16 ...	29-541	... Pannier fixing bolt washer ...	6
17 ...	66-6767	... Pannier frame support bracket ...	2
18 ...	2-204	... Pannier fixing bolt ...	6
19 ...	66-6938	... Pannier carrier steady stay wing nut ...	4
20 ...	66-6915	... Pannier carrier ...	2



CLASSIC  
BIKE SPARES

CARRIER and PANNIERS  
M21, M33 (Spring Frame)

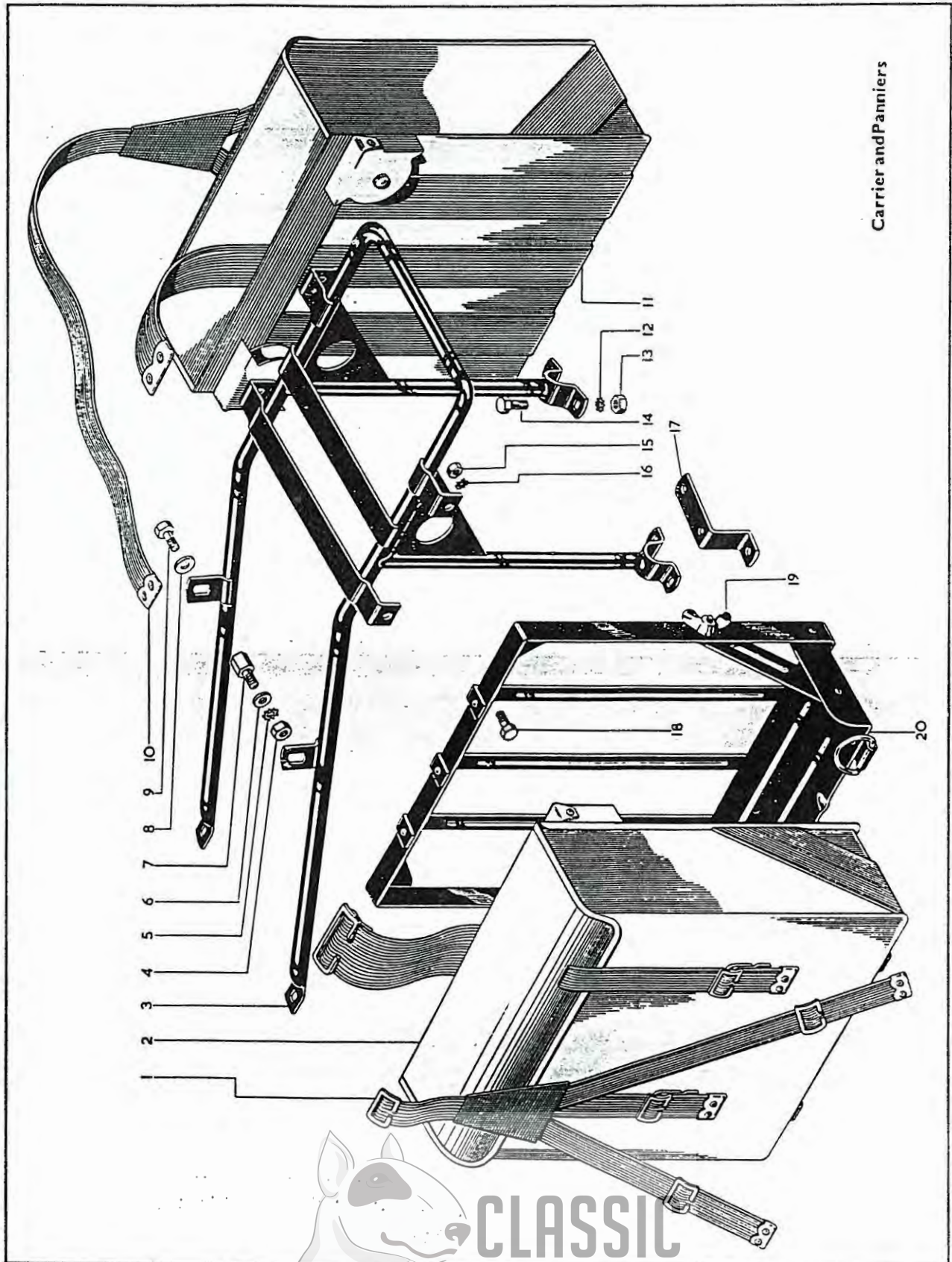

Carrier and Panniers



## PISTON CHART—1949 to 1957

Year	Model	Compression Ratio	PISTON COMPLETE			COMPRESSION RING			SCRAPER RING		
			Standard	½mm. oversize	1mm. oversize	Standard	½mm. oversize	1mm. oversize	Standard	½mm. oversize	1mm. oversize
1949 to 1953	M20	4.9 to 1	66-1190	66-1191	66-1192	66-1090(2)	66-1091(2)	66-1092(2)	66-1100	66-1101	66-1102
1954 to 1957	M20	4.9 to 1	66-1193	66-1194	66-1195	66-1094 (top) 66-1244	66-1095 (top) 66-1245	66-1096 (top) 66-1246	66-1100	66-1101	66-1102
1949 to 1953	M21	5 to 1	66-1198	66-1199	66-1200	66-1090(2)	66-1091(2)	66-1092(2)	66-1100	66-1101	66-1102
1954 to 1957	M21	5 to 1	66-1215	66-1216	66-1217	66-1094 (top) 66-1244	66-1095 (top) 66-1245	66-1096 (top) 66-1246	66-1100	66-1101	66-1102
1949 to 1952	M33	6.8 to 1	65-1244	65-1260	65-1262	65-1250(2)	65-1251(2)	65-1252(2)	65-1253	65-1254	65-1255
1949 to 1952	M33	7.5 to 1	65-1264	65-1266	65-1268	65-1250(2)	65-1251(2)	65-1252(2)	65-1253	65-1254	65-1255
1953 to 1955	M33	6.5 to 1	65-1692	65-1694	65-1696	65-1250(2)	65-1251(2)	65-1252(2)	65-1253	65-1254	65-1255
1953 to 1957	M33	7.5 to 1	65-1660	65-1662	65-1664	65-1250(2)	65-1251(2)	65-1252(2)	65-1253	65-1254	65-1255
1954 to 1957	M21 A.A.	5 to 1	66-1198	66-1199	66-1200	66-1090(2)	66-1091(2)	66-1092(2)	66-1100	66-1101	66-1102

## ENGINE and FRAME MARKINGS—1949 to 1957

Year	Model	Type	Engine	Frame (Rigid)	Frame (Spring) 1951 to 1952
1949 to 1952	M20	500c.c. S.V.	ZM20	ZM20	ZM20S
	M21	600c.c. S.V.	ZM21	ZM20	ZM20S
	M33	500c.c. O.H.V.	ZM33	ZM20	ZM20S
1953 to 1957	M20	500c.c. S.V.	BM20	BM20	BM20S
	M21	600c.c. S.V.	BM21	BM20	BM20S
	M33	500c.c. O.H.V.	BM33	BM20	BM20S

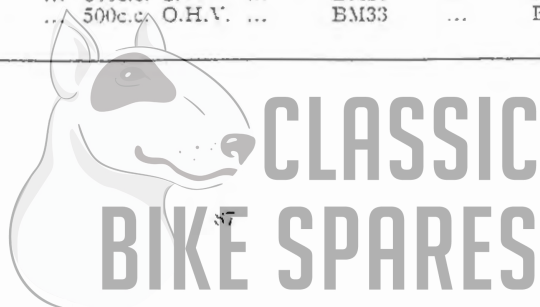



## "M" GROUP

### MOTOR CYCLE EXCHANGE REPLACEMENT SERVICE

1949 TO 1956/7 INCLUSIVE

FULLY GUARANTEED EXCHANGE UNITS

ENGINE		FRAME	
	£ s. d.		£ s. d.
Engine only, S.V. models ... ..	22 0 0	Frame complete, rigid ... ..	11 18 0
Engine only, O.H.V. models ... ..	24 15 0	Frame complete, plunger ... ..	13 0 0
Electrical equipment, reconditioned extra ... ..	10 12 6	Frame front, rigid and plunger ... ..	4 19 0
Re-bushed Con Rod, with new big-end ... ..	2 12 0	Chainstay and Backstay, rigid ... ..	4 13 6
Re-bored Cylinder with new piston ... ..	2 10 6	Chainstay and Backstay, plunger ... ..	5 18 0
Oil pump reconditioned ... ..	1 3 6		
		FORKS	
			£ s. d.
		Telescopic Forks ... ..	11 0 0
		Fork Shaft re-set ... ..	10 0
GEARBOX		WHEELS	
	£ s. d.		£ s. d.
Gearbox, 4-speed, rigid and plunger ... ..	14 0 0	Front Wheel for 7" brake ... ..	5 12 6
Clutch, rigid and plunger ... ..	4 15 0	Front Wheel for 8" brake ... ..	6 0 0
Clutch plate with new inserts ... ..	5 6	Rear Wheel, rigid frame ... ..	5 15 0
Clutch Chainwheel with new inserts ... ..	1 7 6	Rear Wheel, plunger frame ... ..	4 19 0
		BRAKE SHOES	
			£ s. d.
		Brake Shoes relined, 7", per pair ... ..	1 0 0
		Brake Shoes relined, 8", per pair ... ..	1 2 0
PETROL TANK, OIL TANK		SIDECAR WHEELS	
	£ s. d.		£ s. d.
Petrol Tank, repaired, re-chromed and re-enamelled, rigid and plunger ... ..	5 10 0	Sidecar Wheel ... ..	2 17 6
Petrol Tank, re-chromed and re-enamelled only ... ..	3 17 0	Sidecar Spring re-set ... ..	1 0 0
Petrol Tank, repaired and re-enamelled ... ..	3 0 0		
Petrol Tank, re-enamelled only ... ..	1 7 6		
Oil Tank renovated ... ..	1 10 0		

ASK YOUR DEALER FOR FURTHER

