

20-10139 C

BSA SPARES

**350c.c. and 500c.c.
Single Cylinder
O.H.V. Models**

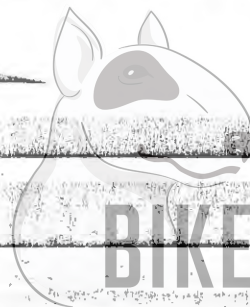

**CLASSIC
BIKE SPARES**

1949 to 1952-3

MODELS

- B 31 . . . 350 c.c. O.H.V.
- B 32 . . . 350 c.c. O.H.V. (Competition)
- B 33 . . . 500 c.c. O.H.V.
- B 34 . . . 500 c.c. O.H.V. (Competition)
- B 32 (Gold Star Clubman's) 350 c.c. O.H.V.
- B 34 (Gold Star Clubman's) 500 c.c. O.H.V.
- B32 (Gold Star) 350 c.c. O.H.V. (Swinging Arm)
- B34 (Gold Star) 500 c.c. O.H.V. (Swinging Arm)



it has
Spa
show.
increas

CATALOGUE OF



BSA Motor Cycles

All communications relating to Spare Parts or Repairs to Motor Cycles to be addressed to B.S.A. Motor Cycles Ltd.
Service Department, Birmingham, 11

B.S.A. MOTOR CYCLES LTD.

Directors: SIR BERNARD DOCKER, K.B.E. (Chairman)

J. LEER, C.B.E. J. A. T. DICKINSON, O.B.E.

Registered Offices and Works

Telephones: BIRMINGHAM VICTORIA 2381 (30 lines)

ARMOURY ROAD, BIRMINGHAM, 11

Telegrams and Cables: "SELMOTO, BIRMINGHAM"

Service, Spares and Repairs Department

Telephone: VICTORIA 2234 (6 lines)

Telegrams and Cables: "SELSERV, BIRMINGHAM"

Contractors to Her Majesty's Government, the War Office, the Admiralty, the Post Office, the Colonial and Foreign Governments

MCE 575-2

Copyright B.S.A. Co. Ltd.

Printed in England.



Buy only



**SUFFIX NUMBERS TO BE USED TO IDENTIFY VARYING FINISHES
FOR MODELS "B" GROUP AND GOLD STAR (CLUBMAN'S)**

- | | |
|--|----------------------|
| /1 Cadmium. | /6 Rust proof Black. |
| /2 Dull Chrome. | /7 Black Enamel. |
| /3 Bright Chrome. | |
| /12 Chrome Plate and Devon Red, lined Gold. | |
| /13 Chrome Plate and Matt Silver, lined Black. | |
| /15 Chrome Plate and Green, lined Gold. | |
| /19 Chrome Plate and Matt Silver, lined Red. | |
| /21 Polished Aluminium. | |
| /36 Chrome Plate and Maroon, lined Gold | |
| /37 Maroon. | |
| /41 Chrome Plate and Maroon. | |
| /44 Chrome Plate and Black. | |

When ordering components with varying finishes—i.e., Petrol tanks, wheels, rims, brake rods, front fork oil seal holder—please state finish required by adding the appropriate suffix number to the part number.

EXAMPLE. B31 Petrol Tank.

Chrome Plate and Devon Red, lined Gold, 65-8161/12

SPARKING PLUGS.

Champion Sparking Plugs Ltd., Feltham, Middlesex.

ELECTRICAL EQUIPMENT.

J. Lucas Ltd., Great King Street, Birmingham.

SPEEDOMETERS.

Smiths Motor Accessories, Cricklewood Works, London.



SPARES

Please carry out the following in order to ensure prompt attention and correct execution of orders.

- 2 When ordering parts the frame and engine numbers must be quoted. The former will be found stamped on the seat or the head tube lug and the latter on the nearside of the crankcase immediately below the cylinder base. It is essential that the component numbers of the parts required be clearly stated.

IMPORTANT.—In quoting engine and frame numbers the full numbers including prefix letters, MUST BE GIVEN

B.S.A. Motor Cycles Ltd. reserve the right to alter the designs or any constructional details of their manufactures at any time without giving notice

COPY OF B.S.A. MOTOR CYCLE SPARE PARTS GUARANTEE

We give the following guarantee with B.S.A. Motor Cycle Spare Parts, instead of the guarantee implied by statute or otherwise, as to the quality or fitness of such parts for the purpose for which they are intended, any such implied guarantee being in all cases excluded, nor can any claim for consequential damages be entertained.

WE GUARANTEE, subject to the conditions mentioned below, that all precautions which are usual and reasonable have been taken by us to secure excellence of materials and workmanship, but this guarantee is to extend and be in force for six months only from the date of purchase, and the damages for which we make ourselves responsible under this guarantee are limited to the replacement of any part which may have proved defective.

WE UNDERTAKE subject to the conditions mentioned below, to make good at any time within six months any defects in these respects. As motor cycles are easily liable to derangement by neglect or misuse, this guarantee does not apply to defects caused by wear and tear, misuse, or neglect. The term "misuse" shall include among others the following acts: The attaching of a sidecar to the motor cycle in such a manner as to cause damage or calculated to render the latter unsafe when ridden; the use of a motor cycle or a motor cycle and sidecar combined when carrying more persons or a greater weight than they were designed to bear. (The 350c.c. and the 500c.c. in the "B" group of machines are not designed for sidecar work.)

CONDITIONS OF GUARANTEE

We do not guarantee the specialities of other firms, such as tyres, electrical equipment, saddles, etc., or of any component part supplied to the order of the purchaser differing from our standard specifications, whether supplied with our motor cycles or otherwise.



B.S.A. OVERSEAS DISTRIBUTORS

ABYSSINIA ...	Arabian Trading Co., (P.O. Box 23), 155, Cunningham St., Addis Ababa.	BRITISH W. AFRICA.	
ADEN ...	Arabian Trading Co., Esplanade.	Gambia ...	Cie. F.A.O., Bathurst.
ALGERIA ...	Fernand Seyfried, 61, Rue de Lyon, Alger.	Gold Coast ...	Cie. F.A.O., P.O. Box 70, Accra.
ANGOLA ...	Casa Americana Ltda, Caixa Postal 1208, Luanda.	Nigeria ...	Cie. F.A.O., P.O. Box 160, Lagos
ARGENTINA ...	Ditlevsen & Cia Ltda., Av. Ingeniero. Huergo 1335, Buenos Aires.	Sierra Leone ...	Cie. F.A.O., Freetown.
AUSTRALIA		BRITISH W. INDIES	
South Australia ...	J. N. Taylor & Co., 121/5, Grenfell St., Adelaide.	Antigua ...	Stephen R. Mendes Ltd., Colonial House, 18, Thames St., St. John's.
Victoria ...	Finlay Bros. (Pty) Ltd., 316/20, Elizabeth St., Melbourne C.I.	Dominica ...	A. C. Shillingford & Co., The Garage, Roseau.
West Australia ...	Mortlock Bros., 914, Hay Street, Perth.	St. Kitts ...	J. W. Thurston & Co. Ltd., Fort St., Basseterre.
N.S.W. ...	Bennett & Wood (Pty) Ltd., Cor. Bathurst and Pitt Sts., Sydney.	St. Lucia ...	Peter & Co., Castries.
Tasmania ...	Sim King (Pty) Ltd., 63, Brisbane St., Launceston.	Montserrat ...	M. S. Osborne, Trescellian House.
AUSTRIA ...	A.u.R. Hinteregger, Johnstrasse 31, Vienna XV.	Nevis ...	J. W. Thurston & Co. Ltd., Fort St., Basseterre, St. Kitts.
AZORES ...	Hayes & Travell Ltd., P.O. Box 56, Ponta Delgada, St. Michael's.	St. Vincent ...	The Caribbean Trading Co., P.O. Box 27, Kingstown.
BAHAMAS ...	Nassau Bicycle Co., P.O. Box 191, Nassau.	BURMA ...	Levetus Limited, 194, Bishopsgate, London, E.C.2, operating through: Fairweather Richards & Co. Ltd., Rangoon.
BARBADOS ...	Redman & Taylors Garage Ltd., P.O. Box 269, Bridgetown.	CANADA.	
BELGIAN CONGO.		British Columbia	Fred Deeley Ltd., 606, E. Broadway Ave., Vancouver.
Albertville ...	La Sima S.C.R.L., P.O. Box 671, Elizabethville.	Newfoundland ...	Edwin Murray Ltd., 256, Water Street, St. John's.
Bukavu ...	Capelluto Touriel & Co., P.O. Box 542.	Nova Scotia ...	British Car Sales Ltd., Cor. North Park & Cornwallis Sts., Halifax.
Coquilhatville ...	Solbena S.C.R.L., P.O. Box 624, Leopoldville.	Ontario ...	Brown's Sports & Cycle Co. Ltd., 343, Yonge St., Toronto.
Elisabethville ...	La Sima, P.O. Box 671.	Quebec ...	Arlington Cycle & Sports Ltd., 1194, University St., Montreal.
Leopoldville ...	Solbena S.C.R.L., P.O. Box 624.	Saskatchewan ...	Nicholson Bros., 245, Second Ave. North, Saskatoon.
Usumbura ...	Capelluto Touriel & Co., P.O. Box 501, Usumbura, Ruanda Urundi.	CANARY ISLANDS	J./Gonzales Suarez, (Apartado No.9), Nicholas Esteveñez 4, Las Palmas.
Stanleyville ...	Nassers Trading Co. Ltd., P.O. Box 71.	CEYLON ...	Cargills (Ceylon) Ltd., Fort, Colombo.
BELGIUM ...	Famo S.A., 571, Grande Chaussée, Berchem, Antwerp.	CHILE ...	Balfour Williamson Merchant Shippers Limited, 7, Gracechurch St., London, E.C.3, operating through: Williamson Balfour & Co. S.A., Blanco 759, Valparaiso.
BERMUDA ...	Holmes, Williams & Purvey, Ltd., P.O. Box 444, Pembroke.	COOK ISLANDS ...	W. H. Watson, Raratonga.
BOLIVIA ...	Balfour Williamson Merchant Shippers Limited, 7, Gracechurch St., London, E.C.3, operating through: Gibbs Williamson (Bolivia) Ltda., Casilla 957, La Paz.	COLOMBIA ...	Balfour Williamson Merchant Shippers Limited, 7, Gracechurch St., London, E.C.3, operating through: Tracey & Co. S.A., Apartado 1196, Bogota.
BORNEO.		COSTA RICA ...	Tiberio Paganella, Ciclo Sport La Casa del Ciclista, Apartado 2321, San Jose.
Br. N. Borneo ...	Harrisons & Crosfield (Borneo) Ltd., Import Dept., Jesselton.	CUBA ...	Isidro Rodriguez, P.O. Box 62, Matanzas.
Sarawak ...	The Borneo Co. Ltd., Thomson Road, Kuching.	CYPRUS ...	B. C. Petrides & Co., P.O. Box 91, Nicosia.
BOUGAINVILLE ...	Bennett & Wood Pty. Ltd., Corner Pitt and Bathurst Streets, Sydney, N.S.W. Australia.	CYRENAICA ...	Mackenzie Metcalfe & Co., P.O. Box 81, Benghazi.
BRAZIL ...	Mesbla S.A., Rua de Passeio 48/54, Rio de Janeiro.	DENMARK ...	B.S.A. Motors & Cycles (H. V. Hansen), Vesterbrogade 101, Copenhagen.
BRITISH E. AFRICA.		DOMINICAN REPUBLIC	General Sales Co. C. por a., Calle Mercedes 98/100, Esq. Hostos, Ciudad Trujillo.
Kenya ...	Bedford, E. A. Ltd. (George Edwards), P.O. Box 1658, Nairobi.	DUTCH GUIANA ...	The New Motor Supply & Importing Co. (P.O. Box 422), Watermolen St., Paramaribo.
Tanganyika ...	International Motor Mart, P.O. Box 409, Dar-es-Salaam.	ECUADOR ...	Balfour Williamson Merchant Shippers Limited, 7, Gracechurch St., London, E.C.3, operating through: Soc. Com. Anglo-Ecuatoriana Ltda. S.A., Apartado 410, Guayaquil.
Uganda ...	The Uganda Co. (Africa) Ltd., P.O. Box 1, Kampala.		
Zanzibar ...	Musa Jusabani, P.O. Box 366, Zanzibar.		
BRITISH GUIANA	Bookers Stores Ltd., 49/53, Water St., Georgetown.		
BRITISH HONDURAS	C. Melhado & Sons, Belize.		
BRITISH SOMALILAND	Arabian Trading Co., Berbera.		

CLASSIC
BIKE⁵ SPARES

EIRE	Huet Bros. Ltd., 7 & 8, Bachelor's Walk, Dublin, C9.	INDIA	Peary Lal & Sons Ltd., Queens Way, New Delhi.
EGYPT	T.W. M. Forsyth, 7 Sharia Maspero, Cairo.		Peary Lal & Co. (E. Punjab) Ltd., Kashmere Gate, Delhi.
ERITREA	Arabian Trading Co., Asmara.		Colonelganj Cycle & Motor Agency, Cawnpore Road, Allahabad.
FALKLAND ISLANDS	McAtasney & Sedgwick, Falkland Store, Stanley.		B. K. Mittal & Co., Staff Road, Amabala.
FIJI	Morris Hedstrom Ltd., Suva.		Calcutta Motor & Cycle Co., Kanpur.
FINLAND	S. & N. Osakeyhtio, Aleksanterinkatu 21A, Helsinki.		Pearl Cycle Stores, Cuttack.
FRANCE	Movea S.A., 79, Ave. de la Grande Armée, Paris XVIe.		Motor Cycle House, Lucknow.
FRENCH EQ. AFRICA			Bombay Cycle Stores Co. Ltd., Nagpur City.
French Guinea ...	Cie. du Niger Français, Conakry		Kedia Cycle Stores, Ranchi.
French Sudan ...	Cie. du Niger Français, Bamako.		Imperial Trading Co., Jamnagar.
Senegal	Nouvelle Société Commerciale Africaine, 31 Boulevard Pinet-Laprade, Dakar.		Mittal Bros., Meerut.
FRENCH INDO CHINA			Sohrab Bros., Hyderabad - DN.
	Movea S.A., 79, Ave. de la Grande Armée, Paris XVIe, France.	INDONESIA ...	Handelmaatschappij L. Platon N.V., Postrommel Dak 776, Djakarta-Kota.
FRENCH MOROCCO	African and Eastern (Near East) Ltd., P.O. Box 519, Casablanca.	IRAN	H. Mohammed Tavakolipoor, Ave. Boozarjomehri, Tehran.
FRENCH SOMALILAND	Arabian Trading Co., Djibouti.	IRAQ	
FRENCH W. AFRICA		ISLE OF REUNION	Movea S.A., 79 Avenue de la Grande Armée, Paris XVIe, France.
Dahomey	Cie. F.A.O., Service Autos, Cotonou.	ISRAEL	S. Gousman & Son, 16, Hakishon St., Tel-Aviv.
French Camerouns	Cie. F.A.O., Duala.	ITALIAN SOMALILAND	Arabian Trading Co., Esplanade, Aden.
Ivory Coast ...	Cie. F.A.O., Abidjan.	ITALY	A. di Palma, Via Cenisio 4, Milan.
GERMANY	Aschoff & Co., G.M.B.H. Oppumer Strasse 67-69, Krefeld.	JAMAICA	B.S.A. Agency Ltd., 9, King St., Kingston.
GIBRALTAR ...	F. G. Bado, 16, Main St.	JAPAN	Balcom Trading Co. Inc., Japan Red Cross Bldg. Annexe, 5-1 Shiba Park, Minatu-Ku, Tokio.
GILBERT and ELLICE ISLANDS	Morris Hedstrom Ltd., Apia, Samoa.	KUWAIT	Abdul Rahman Albisher & Zaid Alkazemi, Kuwait, Persian Gulf.
GREECE	D. F. Papoutsas, 56, Chalcocondillis St., Athens.	LIBERIA	Cie. F.A.O., Mouravia.
GRENADA	Glean's Garage, St. Patrick's.	LUXEMBOURG ...	Famo S.A., 571 Grande Chaussée, Berchem, Antwerp, Belgium.
GUADELOUPE ...	Maison F. D'Alexis, 44, Rue Frehaut, Pointe-à-Pitre.	MADAGASCAR ...	Movea, S.A., 79 Ave. de la Grande Armée, Paris XVIe, France.
GUATEMALA ...	H. J. Nicol & Co. S.C., 8A Avenida Sur No. 109, Guatemala City.	MADEIRA	A. Gomez Loja, P.O. Box 52, Funchal.
HADRAMUT ...	Arabian Trading Co., Esplanade, Aden.	MALAYA	Cycle & Carriage Co. (1926) Ltd., (P.O. Box 142), Orchard Road, Singapore.
HAITI	Valles & Bajoux, Grande Rue 185, (P.O. Box 856), Port-au-Prince.	MALTA	G. Anastasi, 27 and 35 opp. St. John's Church, Valletta.
HAWAII ISLANDS	Schubert's Cyclery Stores (P.O. Box 3443), Cor. Archer and South King Sts., Honolulu, Hawaii.	MAURITIUS	Lising & Co., 32, Royal St., Port Louis.
HOLLAND	Hart Nibbrig & Greeve N.V., Parkstraat 91A, The Hague.	MEXICO	Watson Phillips & Cia. Succs. S.A., Apartado Postal No. 67, Mexico 6 D.F.
HONDURAS ...	M. Liebers, Apartado 51, Tegucigalpa, D.C.		Alejandro Dominguez, Calle 60, Num. 536, Merida, Yucatan.
HONG KONG ...	Levetus Limited, 194, Bishopsgate, London, E.C.2, operating through: British Bicycle Co., 16, Hennessy Road.	NETHERLANDS	Caribbean Sales (P.O. Box 43), Noordstraat No. 543, Oranjestad, Aruba.
ICELAND	Falkinn Ltd., P.O. Box 997, Reykjavik.	ANTILLES (D.W.I.)	Caribbean Sales, P.O. Box 135 Willemstad, Curacao.
INDIA	Levetus Limited, 194, Bishopsgate, London, E.C.2, operating through: Noble Cycle & Motor Co., 225, Hornby Rd., Fort, Bombay.	NEW BRITAIN ...	Bennett & Wood Pty. Ltd., Corner Pitt and Bathurst Streets, Sydney, N.S.W. Australia.
	Bentnick Cycle Co., 1/2 Chowringhee Rd., Calcutta.	NEW CALEDONIA	Agence Automobile, Avenues de Maréchal Foch et de la Victoire, Nouméa.
	Janki Dass & Sons, Jullunder.	NEW GUINEA	Bennett & Wood Pty. Ltd., Corner Bathurst and Pitt Streets, Sidney, N.S.W., Australia.
	Union Co. (Motor) Ltd., Mount Rd., Madras.	NEW HEBRIDES ...	Bennett & Wood Pty. Ltd., Corner Pitt and Bathurst Streets, Sydney, N.S.W. Australia.
		NEW IRELAND ...	Bennett & Wood Pty. Ltd., Corner Pitt and Bathurst Streets, Sydney, N.S.W. Australia.



**CLASSIC
BIKE SPARES**

NEW ZEALAND ... Skeates & White Ltd., 48, Fort St., Auckland, C1.

NICARAGUA ... J. A. Estrada & Cia. Ltda., (Apartado No. 11), Avenida Roosevelt, Managua.

NORWAY ... Erling Sande, Grubbegaten 2/4 Oslo.

NYASALAND ... African Lakes Corp. Ltd., Mandala, Blantyre.

PAKISTAN ... Levetus Limited, 194, Bishopsgate, London, E.C.2, operating through: Shahnawaz Ltd. (P.O. Box 655, Victoria Rd., Karachi).

PANAMA ... Panamusica S.A., P.O. Box 3227, Panama.

PAPUA ... Bennett & Wood Pty. Ltd., Corner Pitt and Bathurst Streets, Sydney, N.S.W. Australia.

PARAGUAY ... J. & F. Perez, 14 de Mayo Pte Franco, Asuncion.

PERU ... Balfour Williamson Merchant Shippers Limited, 7, Gracechurch St., London, E.C.3, operating through: Milne & Co. S.A., Apartado 684, Lima.

PHILLIPINES ... Campos Rueda & Sons, 421/7, Juan Islands, Manila.

PORTO RICO ... M. Castro Fernandez & Co. Ltd., (P.O. Box 1579), San Juan 7, Porto Rico.

PORTUGAL (North) Silva Neto & Ca., Anadia.

(South) Stand Vidal, Travessa de S. Mamede 23/5, Lisbon.

PORTUGUESE EAST AFRICA F. L. Simoes & Co., P.O. Box 13, Beira.

A. A. Azevedo, P.O. Box 482, Lourenco Marques.

Gordhandas Valabhadas & Filhos, P.O. Box 45, Mozambique.

J. Carvalho Furstenau, P.O. Box 27, Quelimane.

PORTUGUESE GUINEA Nunes & Irmao, C.P. 83, Bissau.

PORTUGUESE INDIA M.S.B. Caculo, Nova Goa.

RHODESIA (NORTHERN) Central African Motors Ltd., P.O. Box 1905, Ndola, Northern Rhodesia.

Pals Motors, P.O. Box 51, Lusaka, Northern Rhodesia.

The British Cycle & Sports Co., P.O. Box 274, Livingstone.

RHODESIA (SOUTHERN) Van Rooyen Motor Cycle Works Ltd. 124, Gray St., Bulawayo, Southern Rhodesia.

Alick Stuart Ltd., P.O. Box 306, Bulawayo, Southern Rhodesia.

Kimpton's (Midlands) Ltd., P.O. Box 91, Gwelo.

Cammon Bros., P.O. Box 151, Umtali.

Johnstons Motor Supplies, 28, Pioneer St., Salisbury.

Umtali Cycle Co., P.O. Box 149, Umtali.

SALVADOR ... La Agencia Nacional Ltda., San Salvador.

SAMOA ... Morris Hedstrom Ltd., Apia.

SAUDI ARABIA ... Ebrahim Abdullah Jufali & Bros., P.O. Box 297, Jeddah.

SEYCHELLES ... Chevard & Co., P.O. Box 5, Male.

SOLOMON ISLANDS

Bennett & Wood Pty. Ltd., Corner Pitt and Bathurst Streets, Sydney, N.S.W. Australia.

Morris Hedstrom Ltd., Apia, Samoa.

SOUTH W. AFRICA Terry's Motors, P.O. Box 784, Windhoek.

SPAIN ... Commercial Yacobi, Jose Antonio 45, Madrid.

SPANISH GUINEA J. Gonzalez Suarez, (Apartado No.9), Nicholas Esteveañez 4, Las Palmas, Canary Islands.

SPANISH MOROCCO Marrache & Levy, (P.O. Box 132) Casa Riera 26/28, Tangier, Tangiers.

SUDAN ... Geo. Djerjian & Sons, P.O. Box 364, Khartoum.

SWEDEN ... A-B. E. Fleron, Malmo.

SWITZERLAND ... Fibag, Postfach Zurich 39, Zurich.

Van Leisen S.A., 34, Rue de la Synagogue, Geneva.

SYRIA and LEBANON M. Chafik Khiami & Co., Rue el Nasr 169, Damascus, Syria.

TAHITI ... H. Jean Hamon, Papeete.

TANGIERS ... Marrache & Levy, (P.O. Box 132), Casa Riera 26/28, Tangier.

THAILAND ... Triangle Co. Ltd., (P.O. Box 70), Asdang Rd., Bangkok.

TONGA ... G. H. Jones, P.O. Box 34, Nukualofa, Tonga Islands.

TRINIDAD ... Sports & Games Ltd., (P.O. Box 271), 19 Henry St., Port of Spain.

TRIPOLITANIA ... Felli Pagani Soc. Coll., Via G. Grciani 3, Filiali di Tripoli, Tripoli.

TUNISIA ... Etab. Jean Borg, 35, Rue de Marseille, Tunis.

TURKEY ... Turkish Automobile Trade Co., Beyoglu Istiklal Caddesi 239, (P.O. Box 2032), Istanbul.

UNION OF SOUTH AFRICA.

Cape Province ... Robb Motors (Pty) Ltd., 102 Strand St., Cape Town.

Barnes Garage Ltd., P.O. Box 438, East London.

The Union Cycle Works, P.O. Box 442, Kimberley.

Sahds, P.O. Box 149, Queenstown.

Mitchley Haigh Motors (Pty.) Ltd., P.O. Box 1160, Port Elizabeth.

Natal ... S. & W. Killerby, 469, Smith St., Durban.

Percy Briggs (Pty.) Ltd., P.O. Box 564, Durban.

Orange Free State E. Hoehne & Co., P.O. Box 619, Bloemfontein.

Transvaal ... Fisher & Simmons Ltd., 12, Albert Street, Johannesburg.

Shimwell Bros. (Pty.) Ltd., P.O. Box 2035, Johannesburg.

UNITED STATES OF AMERICA.

East Coast ... Rich Child Cycle Co. Inc., 639, Passaic Ave., Nutley 10, New Jersey.

West Coast ... Hap Alzina, 3074 Broadway, Oakland 11, California.

URUGUAY ... Lina & Cia. S.A., Casilla Correo 1027, Montevideo.

VENEZUELA ... Agencias B.S.A. de Venezuela C.A., Salvador de Leon a Socarras 52, Caracas.

Rafael E. Montero, Calle Soledad 73, Maracaibo, Zulia.

YEMEN ... Arabian Trading Co., Esplanade, Aden.



ENGINE AND FRAME MARKINGS 1949 to 1953.

Model.	Type.	Engine.	Frame.	Year.
B31	350c.c. O.H.V.	ZB31-101 upwards	ZB31-101 upwards	1949
B31 (spring)	350c.c. O.H.V.		ZB31S-101 upwards	
B32	350c.c. O.H.V. Compet'n	ZB32-101 upwards	ZB31-101 upwards	1949
B32	350c.c. O.H.V. Gold Star	ZB32GS-101 upwards	ZB31-101 upwards	1949
B32 (spring)	350c.c. O.H.V. Gold Star		ZB32S-101 upwards	
B33	500c.c. O.H.V.	ZB33-101 upwards	ZB31-101 upwards	1949
B33 (spring)	500c.c. O.H.V.		ZB31S-101 upwards	
B34	500c.c. O.H.V. Compet'n	ZB34-101 upwards	ZB31-101 upwards	1949
B34	500c.c. O.H.V. Gold Star	ZB34GS-101 upwards	ZB31-101 upwards	1949
B34 (spring)	500c.c. O.H.V. Gold Star		ZB32S-101 upwards	
B31	350c.c. O.H.V.	ZB31-5001 upwards	ZB31-9001 upwards	1950
B31 (spring)	350c.c. O.H.V.		ZB31S-5001 upwards	
B32	350c.c. O.H.V. Compet'n	ZB32-3001 upwards	ZB31-9001 upwards	1950
B32 (spring)	350c.c. O.H.V. Compet'n		ZB31S-5001 upwards	
B32	350c.c. O.H.V. Gold Star	ZB32GS-2001 upwards	ZB31-9001 upwards	1950
B32 (spring)	350c.c. O.H.V. Gold Star		ZB32S-2001 upwards	
B33	500c.c. O.H.V.	ZB33-4001 upwards	ZB31-9001 upwards	1950
B33 (spring)	500c.c. O.H.V.		ZB31S-5001 upwards	
B34	500c.c. O.H.V. Compet'n	ZB34-2001 upwards	ZB31-9001 upwards	1950
B34 (spring)	500c.c. O.H.V. Compet'n		ZB31S-5001 upwards	
B34	500c.c. O.H.V. Gold Star	ZB34GS-2001 upwards	ZB31-9001 upwards	1950
B34 (spring)	500c.c. O.H.V. Gold Star		ZB32S-2001 upwards	
B31	350c.c. O.H.V.	ZB31-15001 upwards	ZB31-14001 upwards	1951
B31 (spring)	350c.c. O.H.V.		ZB31S-10001 upwards	
B32	350c.c. O.H.V. Compet'n	ZB32-4001 upwards	ZB31-14001 upwards	1951
B32 (spring)	350c.c. O.H.V. Compet'n		ZB31S-10001 upwards	
B32	350c.c. O.H.V. Gold Star	ZB32GS-3001 upwards	ZB31-14001 upwards	1951
B32 (spring)	350c.c. O.H.V. Gold Star		ZB32S-3001 upwards	
B32 alloy head & barrel	350c.c. O.H.V. Compet'n	ZB32A-4001 upwards	As B32 rigid or spring fr.	1951
B33	500c.c. O.H.V.	ZB33-7001 upwards	ZB31-14001 upwards	1951
B33 (spring)	500c.c. O.H.V.		ZB31S-10001 upwards	
B34	500c.c. O.H.V. Compet'n	ZB34GS-3001 upwards	ZB31-14001 upwards	1951
B34 (spring)	500c.c. O.H.V. Compet'n		ZB31S-10001 upwards	
B34	500c.c. O.H.V. Gold Star	ZB34GS-3001 upwards	ZB31-14001 upwards	1951
B34 (spring)	500c.c. O.H.V. Gold Star		ZB32S-3001 upwards	
B34 alloy head & barrel	500c.c. O.H.V. Compet'n	ZB34A-3001 upwards	As B34 rigid or spring fr.	1951

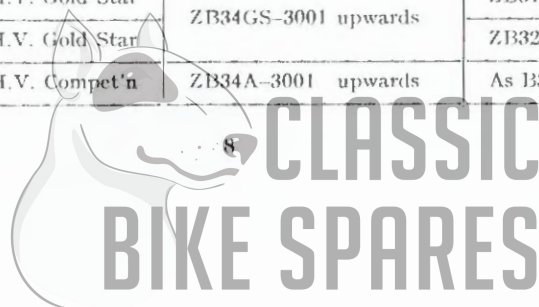

PISTONS CHART 1953.

Model	Compression Ratio.	PISTONS COMPLETE.			Compression Rings.	Scraper Rings.
		Standard.	1/2 mm. oversize.	1 mm. oversize.		
B31 ...	6.5 to 1	65-809	---	---	65-744	65-735
B31 ...	6.5 to 1	---	65-811	---	65-745	65-736
B31 ...	6.5 to 1	---	---	65-813	65-746	65-737
B32 ...	6.5 to 1	65-1679	---	---	65-744	65-735
B32 ...	6.5 to 1	---	65-1745	---	65-745	65-736
B32 ...	6.5 to 1	---	---	65-1746	65-746	65-737
B33 ...	6.5 to 1	65-1692	---	---	65-1250	65-1253
B33 ...	6.5 to 1	---	65-1694	---	65-1251	65-1254
B33 ...	6.5 to 1	---	---	65-1696	65-1252	65-1255
B33 ...	7.5 to 1	65-1660	---	---	65-1250	65-1253
B33 ...	7.5 to 1	---	65-1662	---	65-1251	65-1254
B33 ...	7.5 to 1	---	---	65-1664	65-1252	65-1255
B34 ...	6.8 to 1	65-1244	---	---	65-1250	65-1253
B34 ...	6.8 to 1	---	65-1260	---	65-1251	65-1254
B34 ...	6.8 to 1	---	---	65-1262	65-1252	65-1255
350c.c. Gold Star	6.5 to 1	65-1680	---	---	65-1621	65-490
350c.c. Gold Star	6.5 to 1	---	65-1682	---	65-1622	65-491
350c.c. Gold Star	6.5 to 1	---	---	65-1684	65-1623	65-492
350c.c. Gold Star	8 to 1	65-1615	---	---	65-1621	65-490
350c.c. Gold Star	8 to 1	---	65-1617	---	65-1622	65-491
350c.c. Gold Star	8 to 1	---	---	65-1619	65-1623	65-492
350c.c. Gold Star	8.5 to 1	65-1666	---	---	65-1621	65-490
350c.c. Gold Star	8.5 to 1	---	65-1668	---	65-1622	65-491
350c.c. Gold Star	8.5 to 1	---	---	65-1670	65-1623	65-492
350c.c. Gold Star	9 to 1	65-1673	---	---	65-1621	65-490
350c.c. Gold Star	9 to 1	---	65-1675	---	65-1622	65-491
350c.c. Gold Star	9 to 1	---	---	65-1677	65-1623	65-492
350c.c. Gold Star	12.25 to 1	65-1686	---	---	65-1621	65-490
350c.c. Gold Star	12.25 to 1	---	65-1688	---	65-1622	65-491
350c.c. Gold Star	12.25 to 1	---	---	65-1690	65-1623	65-492
500c.c. Gold Star	6.8 to 1	65-1464	---	---	65-1453	65-1253
500c.c. Gold Star	6.8 to 1	---	65-1465	---	65-1261	65-1254
500c.c. Gold Star	6.8 to 1	---	---	65-1466	65-1455	65-1255
500c.c. Gold Star	7.5 to 1	65-1467	---	---	65-1453	65-1253
500c.c. Gold Star	7.5 to 1	---	65-1468	---	65-1454	65-1254
500c.c. Gold Star	7.5 to 1	---	---	65-1469	65-1455	65-1255
500c.c. Gold Star	9 to 1	65-1537	---	---	65-1453	24-1792
500c.c. Gold Star	9 to 1	---	65-1538	---	65-1454	24-1793
500c.c. Gold Star	9 to 1	---	---	65-1539	65-1455	24-1794

TRANSMISSION CHAINS (Front and Rear).

Model.	Frame.	Part No.	Front Transmission.	Rear Transmission.
B31 ...	Rigid	24-8931	1/2"x.305"x69 pitches	---
B32 ...	Rigid	24-8930	1/2"x.305"x68 pitches	---
B33-B34 ...	Rigid	24-8932	1/2"x.305"x70 pitches	---
B31-B33 ...	Rigid	65-9191	---	5/8"x 1/2"x93 pitches
B32-B34 ...	Rigid	15-8967	---	5/8"x 1/2"x91 pitches
B31 ...	Spring	24-8931	1/2"x.305"x69 pitches	---
B32 ...	Spring	24-8930	1/2"x.305"x68 pitches	---
B33-B34 ...	Spring	24-8932	1/2"x.305"x70 pitches	---
B31-B33 ...	Spring	15-817	---	5/8"x 1/2"x96 pitches
B32 ...	Spring	24-8713	---	5/8"x 1/2"x95 pitches
B34 ...	Spring	15-8967	---	5/8"x 1/2"x91 pitches
350c.c. ...	Scrambles	---	---	---
500c.c. ...	Gold Star	24-8716	1/2"x.305"x67 pitches	---
350c.c. ...	Clubmans	---	---	---
350c.c. ...	Gold Star	24-8930	1/2"x.305"x68 pitches	---
350c.c. ...	Clubmans	---	---	---
500c.c. ...	Gold Star	24-8931	1/2"x.305"x69 pitches	---
350c.c. ...	Scrambles	---	---	---
500c.c. ...	Gold Star	66-9162	---	5/8"x 1/2"x98 pitches
350c.c. ...	Clubmans	---	---	---
500c.c. ...	Gold Star	66-9160	---	5/8"x 1/2"x97 pitches

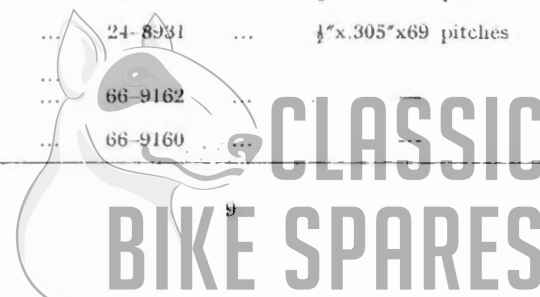

CLASSIC
BIKE SPARES

ENGINE
"B" Group

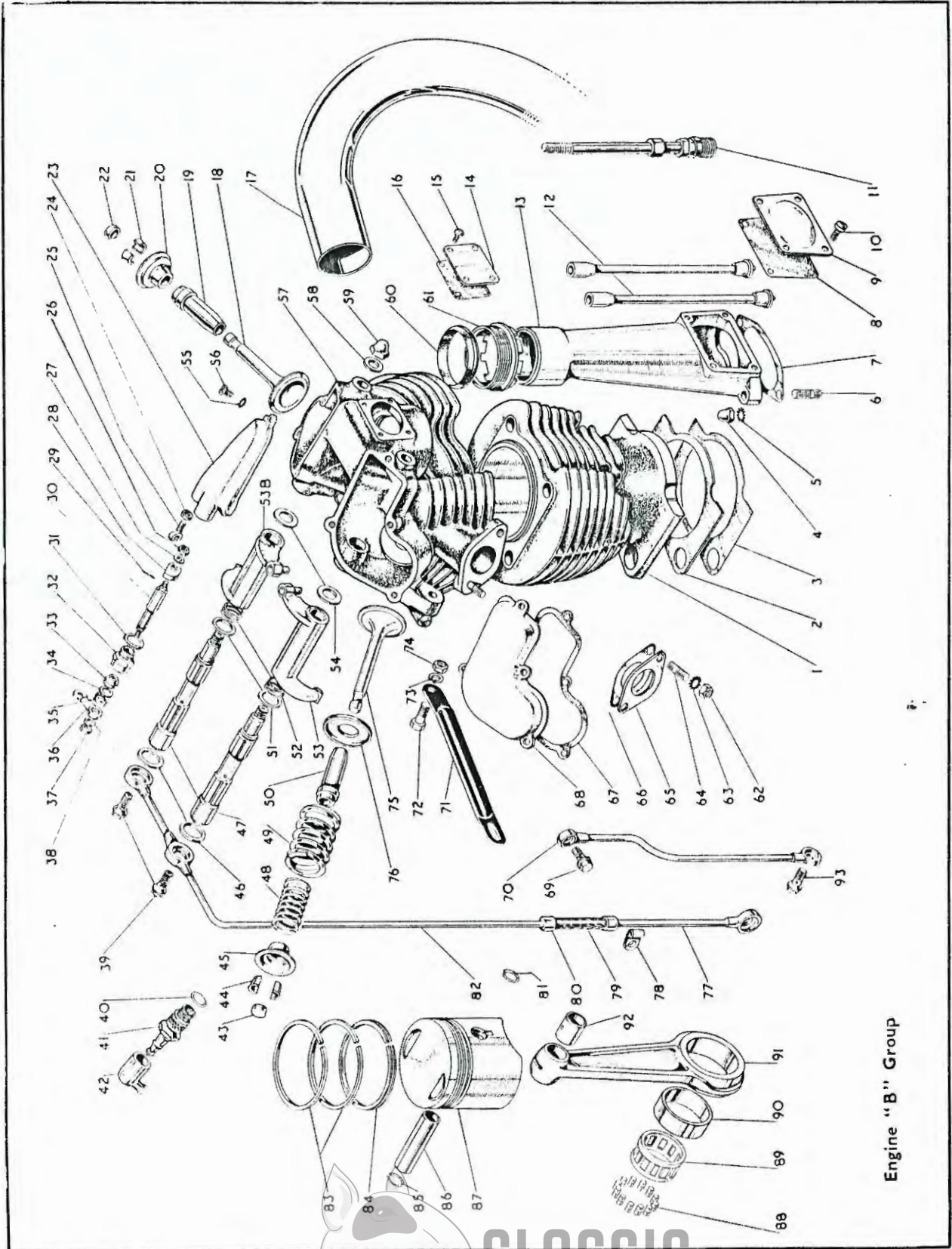

Engine "B" Group

Plate 1

ENGINE
"B" Group

Engine
"B" Group

Plate Ref. Number.	Models.	Part No.	Description.	Number per set.
1	B31 B32	65-1062	Cylinder barrel	1
	B33 B34	65-1229	Cylinder barrel	1
2	B33 B34	66-86	Cylinder base gasket	1
3	B31 B32 B33 B34	66-92	Cylinder base gasket	1
4	B31 B32 B33 B34	65-930	Push rod cover stud nut	2
5	B31 B32 B33 B34	29-541	Push rod cover stud nut washer	2
6	B31 B32 B33 B34	24-4227	Push rod cover tube stud	2
7	B31 B32 B33 B34	66-1379	Push rod cover tube washer	1
8	B31 B32 B33 B34	66-1937	Tappet recess cover washer	1
9	B31 B32 B33 B34	66-1936	Tappet recess cover	1
10	B31 B32 B33 B34	29-2158	Tappet recess cover screw	4
11	B31 B32 B33 B34	66-115	Cylinder holding down bolt	4
12	B31 B32 B33 B34	65-1084	Push rod	2
13	B31 B32 B33 B34	65-1080	Push rod cover tube	1
14	B31 B32 B33 B34	65-1142	Valve rocker inspection cover	1
15	B31 B32 B33 B34	2-2582	Valve rocker inspection cover screw	4
16	B31 B32 B33 B34	65-1143	Valve rocker inspection cover washer	1
17	Rigid Frame B32 B34	65-2687	Exhaust pipe	1
	Rigid Frame B31 B32 B33 B34	65-2840	Exhaust pipe	1
	Spring Frame	65-2687	Exhaust pipe	1
18	B31 B32	65-1110	Valve (exhaust)	1
	B33 B34	65-1240	Valve (exhaust)	1
19	B31 B32	65-1514	Valve guide (exhaust)	1
	B33 B34	65-1516	Valve guide (exhaust)	1
20	B31 B32 B33 B34	65-1149	Valve spring collar (exhaust)	1
21	B31 B32 B33 B34	15-1525	Valve split cotter (exhaust)	2 halves
22	B31 B32	31-103	Valve stem cap (exhaust)	1
23	B31 B32 B33 B34	65-1160	Cylinder head cover (exhaust)	1
24	B31 B32 B33 B34	2-443	Exhaust lifter cable holder nut	1
25	B31 B32 B33 B34	27-1163	Exhaust lifter cable holder	1
26	B31 B32 B33 B34	2-443	Exhaust lifter spindle nut	2
27	B31 B32 B33 B34	2-525	Exhaust lifter spindle washer	2
28	B31 B32 B33 B34	65-1137	Exhaust lifter	1
29	B31 B32 B33 B34	35-701	Exhaust lifter spindle split pin	1
30	B31 B32 B33 B34	65-1165	Exhaust lifter spindle	1
31	B31 B32 B33 B34	2-2894	Exhaust lifter bush washer (lubre)	1
32	B31 B32 B33 B34	65-387	Exhaust lifter bush	1
33	B31 B32 B33 B34	65-401	Exhaust lifter spindle washer (felt)	1
34	B31 B32 B33 B34	65-402	Exhaust lifter spindle washer	1
35	B31 B32 B33 B34	65-403	Exhaust lifter spindle spring	1
36	B31 B32 B33 B34	66-1431	Exhaust lifter lever	1
37	B31 B32 B33 B34	2-443	Exhaust lifter spindle nut	2
38	B31 B32 B33 B34	2-525	Exhaust lifter spindle washer	2
39	B31 B32 B33 B34	65-317	Rocker oil feed pipe banjo screw	2
	B31 B32 B33 B34	65-306	Rocker oil feed pipe banjo screw	2
40	B31 B32 B33 B34	66-102	Sparking plug washer	1
41	B31 B32 B33 B34	65-114	Sparking plug	1
42	B31 B32 B33 B34	65-213	Sparking plug waterproof cover	1
43	B31 B32	65-209	Valve stem cap (inlet)	1
44	B31 B32 B33 B34	29-410	Valve split cotter (inlet)	2 halves
45	B31 B32 B33 B34	65-1149	Valve spring collar (inlet)	1
46	B31 B32 B33 B34	31-8430	Rocker oil feed pipe union washer	2
47	B31 B32 B33 B34	65-1161	Valve rocker fulcrum pin	2
48	B31 B32 B33 B34	65-1146	Valve spring (inner)	2
49	B31 B32 B33 B34	65-1147	Valve spring (outer)	2
50	B31 B32	65-1513	Valve guide (inlet)	1
	B33 B34	65-1515	Valve guide (inlet)	1
51	B31 B32 B33 B34	65-1118	Valve rocker fulcrum pin washer	2
52	B31 B32 B33 B34	65-1117	Valve rocker fulcrum spring	2
53	B31 B32 B33 B34	65-1102	Valve rocker (inlet)	1
53B	B31 B32 B33 B34	65-1100	Valve rocker (exhaust)	1
54	B31 B32 B33 B34	27-1111	Valve rocker spindle thrust washer	2
55	B31 B32 B33 B34	29-541	Cylinder head cover washer	8
56	B31 B32 B33 B34	65-1166	Cylinder head cover screw	8
57	B31 B32	65-1156	Cylinder head	1
	B33 B34	65-1226	Cylinder head	1
58	B31 B32 B33 B34	36-481	Valve rocker spindle nut washer	2
59	B31 B32 B33 B34	65-311	Valve rocker spindle nut	2
60	B31 B32 B33 B34	66-1367	Push rod cover tube gland packing	1

*Fitted on and after Frame Number Z1331-19001.

CLASSIC
BIKE SPARES

Plate 1—continued.

ENGINE

"B" Group

Plate Ref. Number.	Model.	Part No.	Description.	Number per set.
61	B31 B32 B33 B34	65-1082	Push rod cover tube gland nut	1
62	B31 B32 B33 B34	2-49	Carburettor stud nut	2
63	B31 B32 B33 B34	36-382	Carburettor stud nut washer	2
64	B31 B32 B33 B34	24-5205	Carburettor stud	2
65	B31 B32	65-1163	Carburettor flange washer (Tufnol)	1
	B33 B34	65-1238	Carburettor flange washer (Tufnol)	1
66	B31 B32	65-1162	Carburettor flange washer (paper)	2
	B33 B34	65-1232	Carburettor flange washer (paper)	2
67	B31 B32 B33 B34	65-1164	Cylinder head cover washer (paper)	2
68	B31 B32 B33 B34	65-1159	Cylinder head cover (inlet)	1
69	B31 B32 B33 B34	26-1253	Oil return pipe banjo screw (top)	1
70	B31 B32 B33 B34	65-1215	Oil return pipe complete	1
71	B31 B32 B33 B34	65-1153	Engine steady stay	1
72	B31 B32 B33 B34	15-480	Engine steady stay bolt	1
73	B31 B32 B33 B34	24-8784	Engine steady stay washer	1
74	B31 B32 B33 B34	2-49	Engine steady stay bolt nut	1
75	B31 B32	65-1111	Valve (inlet)	1
	B33 B34	65-1239	Valve (inlet)	1
76	B31 B32 B33 B34	65-1519	Valve spring seat	2
77	B32 B34	65-1547	Rocker oil feed pipe complete with rubber connection	1
	B32 B34	65-1364	Rocker oil feed pipe complete (1949/50)	1
78	B31 B32 B33 B34	65-1366	Rocker oil feed pipe clip	1
79	B32 B34	66-8338	Rocker oil feed pipe rubber connection	1
80	B32 B34	66-8339	Rocker feed pipe connection ferrule	2
81	B31 B32 B33 B34	66-954	Gudgeon pin retaining circlip	2
82	B31 B33	65-1544	Rocker oil feed pipe complete (all metal)	1
	B31 B33	65-1119	Rocker oil feed pipe complete (1949/50)	1
83	B31 B33	65-744	Compression ring (Standard)	2
	B33 B34	65-1250	Compression ring (Standard)	2
84	B31 B32	65-735	Piston scraper ring	1
	B33 B34	65-1253	Piston scraper ring	1
85	B31 B32 B33 B34	66-954	Gudgeon pin retaining circlip	2
86	B31 B32	65-440	Gudgeon pin	1
	B33 B34	66-953	Gudgeon pin	1
87	B31 B32	65-758	Piston complete with rings, gudgeon pin and retaining circlips	1
	B33 B34	65-1244	Piston complete with rings, gudgeon pin and retaining circlips	1
88	B31 B32 B33 B34	24-375	Crankpin roller	24
89	B31 B32 B33 B34	66-506	Roller cage	1
90	B31 B32 B33 B34	66-490	Connecting rod big-end bush	1
91	B31 B32 B33 B34	66-482	Connecting rod complete	1
92	B31 B32 B33 B34	66-492	Connecting rod small end bush	1
93	B31 B32 B33 B34	26-1253	Oil return pipe banjo screw (bottom)	1

Plate 2

ENGINE

"B" Group

Plate Ref. Number.	Models.	Part No.	Description.	Number per set.
1	B31 B32 B33 B34	1/2" diam.	Oil valve spring ball	1
2	B31 B32 B33 B34	66-1684	Oil valve spring	1
3	B31 B32 B33 B34	66-1683	Oil valve retaining screw washer (fibre)	1
4	B31 B32 B33 B34	65-2188	Oil valve spring retaining screw	1
5	B31 B32 B33 B34	65-2157	Timing cover screw	9
6	B31 B32 B33 B34	65-2143	Timing cover	1
7	B31 B32 B33 B34	66-1920	Timing cover washer	1
8	B31 B32 B33 B34	66-698	Engine shaft oil feed pipe	1
9	B31 B32 B33 B34	29-905	Engine shaft timing pinion nut	1
10	B31 B32 B33 B34	66-1923	Timing cover oil feed washer (rubber)	2
11	B31 B32 B33 B34	66-2007	Cam pinion spindle bolt	2
12	B31 B32 B33 B34	66-2008	Timing gear plate with bearing	1
13	B31 B32 B33 B34	65-441	Cam pinion bush (exhaust)	2
14	B31 B32 B33 B34	65-2420	Cam pinion complete (exhaust)	1
15	B31 B32 B33 B34	65-2426	Cam pinion spindle (exhaust)	1
16	B31 B32 B33 B34	65-692	Engine shaft timing pinion	1

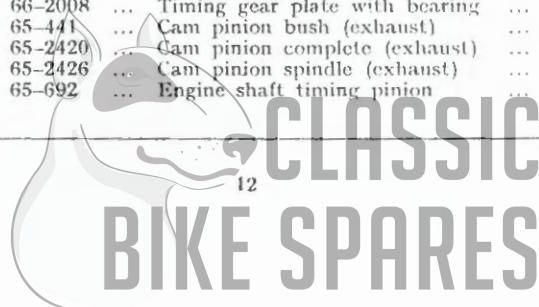

ENGINE
"B" Group

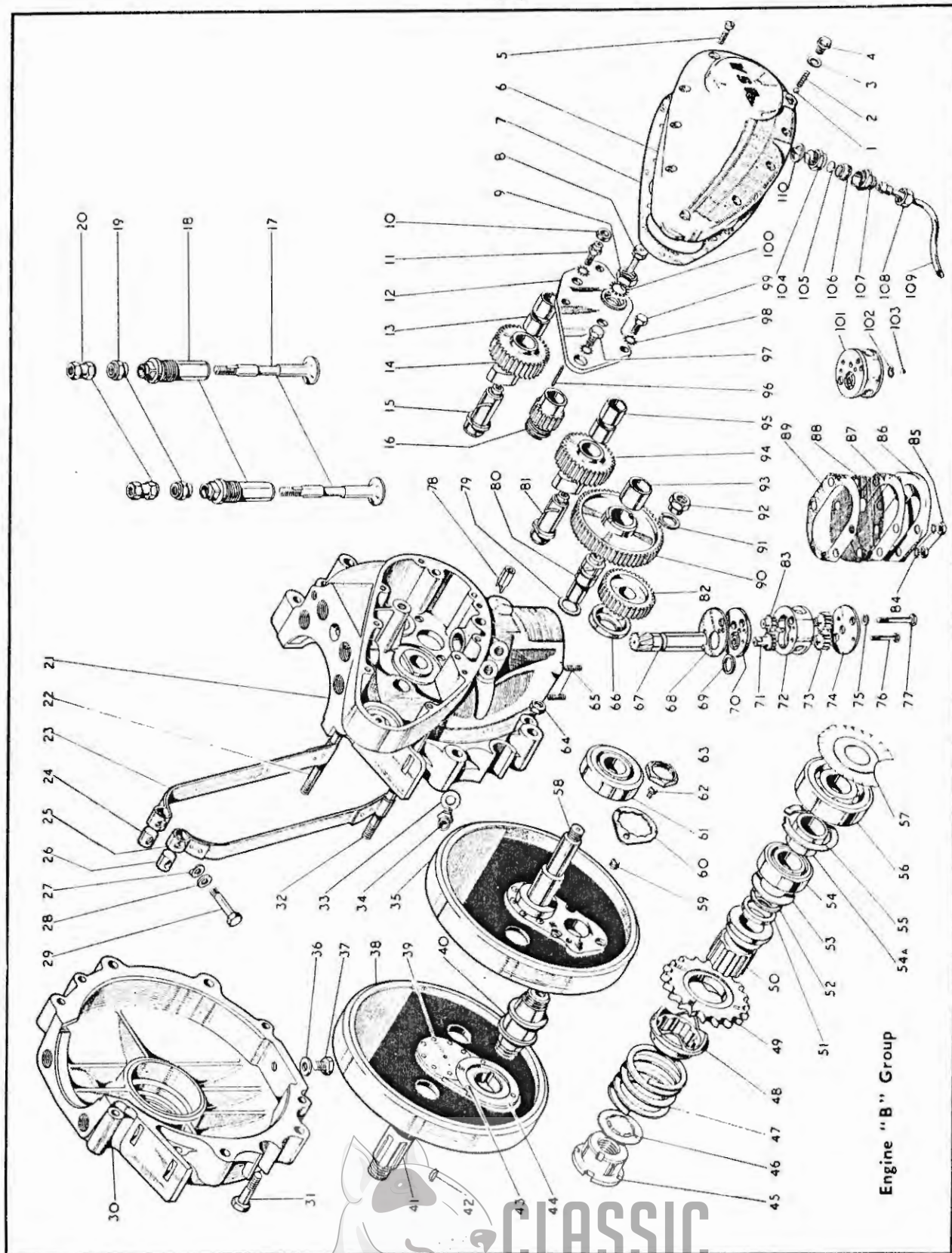

ENGINE

"B" Group

Plate Ref. Number	Models.	Part No.	Description.	Number per set.
17	B31 B32 B33 B34	66-1493	Tappet (inlet and exhaust)	2
18	B31 B32 B33 B34	66-1494	Tappet guide (inlet and exhaust)	2
19	B31 B32 B33 B34	15-6524	Tappet locknut	2
20	B31 B32 B33 B34	66-1511	Tappet head (inlet and exhaust)	2
21	B31 B32 B33 B34	66-1616	Crankcase with fixed fittings (gearside)	1
22	B31 B32 B33 B34	31-212	Crankcase stud (top) (rear)	1
23	B31 B32 B33 B34	66-2321	Magdyno strap complete (short)	1
24	B31 B32 B33 B34	65-2353	Magdyno strap eye plug (tapped)	1
25	B31 B32 B33 B34	66-2320	Magdyno strap complete (long)	1
26	B31 B32 B33 B34	65-2352	Magdyno strap eye plug (plain)	1
27	B31 B32 B33 B34	29-4662	Magdyno strap eye plug saddle washer	1
28	B31 B32 B33 B34	2-923	Magdyno strap clip bolt washer	1
29	B31 B32 B33 B34	27-5156	Magdyno strap clip bolt	1
30	B31 B32 B33 B34	66-1642	Crankcase with fixed fittings (drive side)	1
31	B31 B32 B33 B34	15-1355	Crankcase connecting bolt	3
32	B31 B32 B33 B34	24-949	Crankcase stud (rear)	1
33	B31 B32 B33 B34	66-1683	Crankcase oil pipe adaptor washer	2
34	B31 B32 B33 B34	65-2252	Crankcase oil pipe adaptor	2
35	B31 B32 B33 B34	65-1125	Flywheel with engine shaft (gearside)	1
	B33 B34	65-1235	Flywheel with engine shaft (gearside)	1
36	B31 B32 B33 B34	2-4553	Crankcase drain plug washer (fibre)	1
37	B31 B32 B33 B34	28-243	Crankcase drain plug	1
38	B31 B32	65-1123	Flywheel with engine shaft (drive side)	1
	B33 B34	65-1233	Flywheel with engine shaft (drive side)	1
39	B31 B32 B33 B34	27-1239	Engine shaft rivet	14
40	B31 B32 B33 B34	66-545	Crankpin	1
41	B31 B32 B33 B34	65-1128	Engine shaft (drive side)	1
42	B31 B32 B33 B34	2-36	Crankpin key	1
43	B31 B32 B33 B34	66-630	Thrust washer rivet	6
44	B31 B32 B33 B34	66-629	Thrust washer	2
45	B31 B32 B33 B34	65-2520	Cush drive bearing nut	1
46	B31 B32 B33 B34	65-2521	Cush drive bearing lockwasher	1
47	B31 B32 B33 B34	66-1706	Cush drive spring	1
48	B31 B32 B33 B34	15-1555	Cush drive sleeve	1
	B32 B34	65-2431	Cush drive sleeve (for use with 65-2430 sprocket)	1
49	B31	15-1567	Engine sprocket (17T)	1
	B32	15-1568	Engine sprocket (16T)	1
	B32	65-2430	Engine sprocket (15T)	1
	B33	15-1565	Engine sprocket (19T)	1
	B34	15-1564	Engine sprocket (20T)	1
50	B31 B32 B33 B34	65-2523	Cush drive bearing	1
51	B31 B32 B33 B34	65-2528	Cush drive distance piece (.320"-.325")	—
	B31 B32 B33 B34	65-2529	Cush drive distance piece (.288"-.293")	—
	B31 B32 B33 B34	65-2530	Cush drive distance piece (.256"-.261")	—
52	B31 B32 B33 B34	66-1707	Cush drive bearing alignment washer (.032")	—
	B31 B32 B33 B34	66-1708	Cush drive bearing alignment washer (.064")	—
53	B31 B32 B33 B34	66-661	Engine shaft shim (drive side)	1
54	B31 B32 B33 B34	65-2045	Ball bearing (drive side)	1
54A	B31 B32 B33 B34	66-660	Engine shaft distance collar	1
55	B31 B32 B33 B34	65-2240	Main bearing spring ring	1
56	B31 B32 B33 B34	24-724	Roller bearing (drive side)	1
57	B31 B32 B33 B34	24-2113	Oil flinger	1
58	B31 B32 B33 B34	65-1129	Engine shaft (gearside)	1
59	B31 B32 B33 B34	65-479	Crankpin oil hole grub screw	1
60	B31 B32 B33 B34	31-300	Crankpin nut locking washer	2
61	B31 B32 B33 B34	24-722	Roller bearing (gearside)	1
62	B31 B32 B33 B34	2-77	Crankpin nut locking washer screw	2
63	B31 B32 B33 B34	31-298	Crankpin nut	2
64	B31 B32 B33 B34	2-49	Crankcase connecting bolt nut	5
65	B31 B32 B33 B34	31-222	Crankcase scavenge cover stud	4
66	B31 B32 B33 B34	65-2316	Magdyno driving pinion oil seal	1
67	B31 B32 B33 B34	66-2620	Oil pump driving spindle	1
68	B31 B32 B33 B34	65-2618	Oil pump and crankcase joint washer	1
69	B31 B32 B33 B34	65-2606	Oil pump top plate washer	1
70	B31 B32 B33 B34	65-2598	Oil pump top plate	1
71	B31 B32 B33 B34	65-2601	Oil pump feed gear (driver)	1
72	B31 B32 B33 B34	65-2596	Oil pump body	1

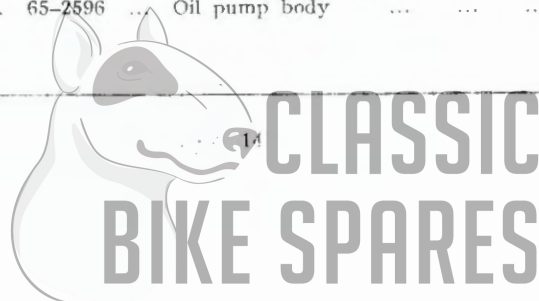

CLASSIC
BIKE SPARES

Plate 2—continued

ENGINE

"B" Group

Plate Ref. Number	Models.	Part No.	Description.	Number per set.
73	B31 B32 B33 B34	65-2599	Oil pump scavenge gear	2
74	B31 B32 B33 B34	65-2625	Oil pump bottom plate	1
75	B31 B32 B33 B34	24-978	Oil pump bolt washer (spring)	2
76	B31 B32 B33 B34	15-848	Oil pump bolt	2
77	B31 B32 B33 B34	65-2604	Oil pump fixing bolt	2
78	B31 B32 B33 B34	65-2580	Oil pump driving spindle retaining pin	1
79	B31 B32 B33 B34	36-3528	Idle pinion thrust washer	1
80	B31 B32 B33 B34	65-2335	Idle pinion spindle	1
81	B31 B32 B33 B34	65-2425	Cam pinion spindle (inlet)	1
82	B31 B32 B33 B34	65-2334	Magdyno driving pinion	1
83	B31 B32 B33 B34	65-2600	Oil pump feed gear (driven)	1
84	B31 B32 B33 B34	29-541	Crankcase scavenge cover stud washer	4
85	B31 B32 B33 B34	2-51	Crankcase scavenge cover stud nut	4
86	B31 B32 B33 B34	65-2811	Crankcase scavenge cover	1
87	B31 B32 B33 B34	65-2612	Crankcase scavenge cover washer	1
88	B31 B32 B33 B34	65-2623	Crankcase scavenge gauze	1
89	B31 B32 B33 B34	65-2612	Crankcase scavenge cover washer	1
90	B31 B32 B33 B34	66-2250	Magdyno drive idler pinion complete	1
91	B31 B32 B33 B34	2-2903	Magdyno driving pinion washer (spring)	1
92	B31 B32 B33 B34	24-195	Magdyno driving pinion nut	1
93	B31 B32 B33 B34	65-2336	Idle pinion bush	1
94	B31 B32 B33 B34	65-2420	Cam pinion complete (inlet)	1
95	B31 B32 B33 B34	65-441	Cam pinion bush (inlet)	2
96	B31 B32 B33 B34	65-693	Engine shaft timing pinion key	1
97	B31 B32 B33 B34	1-5069	Timing gear plate bolt	1
98	B31 B32 B33 B34	36-382	Timing gear plate washer (shakeproof)	6
99	B31 B32 B33 B34	21-2902	Timing gear plate bolt	3
100	B31 B32 B33 B34	65-695	Timing pinion locking washer	1
101	B31 B32 B33 B34	65-2619	Oil pump complete	1
102	B31 B32 B33 B34	65-2622	Oil pump ball retaining circlip	1
103	B31 B32 B33 B34	7/32" dia.	Oil pump ball	1
104	B31 B32 B33 B34	65-2168	Timing cover air release adaptor	1
105	B31 B32 B33 B34	15-82	Air release disc	1
106	B31 B32 B33 B34	65-2171	Air release adaptor screw	1
107	B31 B32 B33 B34	65-2165	Timing cover air release body	1
108	B31 B32 B33 B34	66-8332	Breather extension pipe nut	1
109	B31 B32 B33 B34	65-2166	Timing cover breather extension pipe	1
110	B31 B32 B33 B34	31-8430	Air release adaptor washer (fibre)	1

Engine
Gold Star

Plate 3

ENGINE.

Gold Star (Clubman's) 350c.c. and 500c.c.

Plate Ref. Number.	Models.	Part No.	Description.	Number per set.
1	Gold Star Clubmans 500 c.c.	65-1503	Cylinder barrel complete with liner	1
	Gold Star Clubmans 350 c.c.	65-1601	Cylinder barrel complete with liner	1
2	Gold Star Clubmans 500 c.c.	65-1501	Cylinder head complete	1
	Gold Star Clubmans 350 c.c.	65-1604	Cylinder head	1
3	Gold Star Clubmans	65-1587	Rocker box joint washer (Tower)	1
4	Gold Star Clubmans	65-1591	Cylinder head and rocker box stud (long)	3
5	Gold Star Clubmans	65-1084	Push rod complete	2
6	Gold Star Clubmans 500 c.c.	65-2822	Exhaust pipe complete (for use with megaphone)	1
	Gold Star Clubmans 500 c.c.	65-2812	Exhaust pipe complete (for use with silencer)	1
	Gold Star Clubmans 350 c.c.	65-2798	Exhaust pipe only	1
7	Gold Star Clubmans	65-1592	Cylinder head and rocker box stud (short)	6

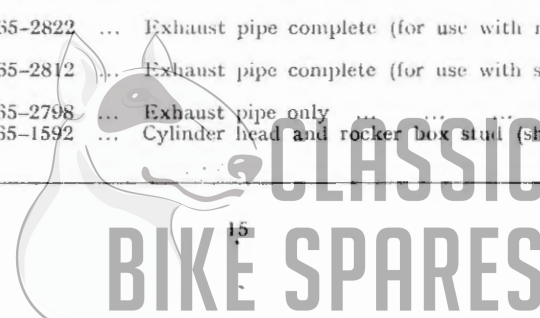

ENGINE
(Clubman's) 350c.c. and 500c.c.

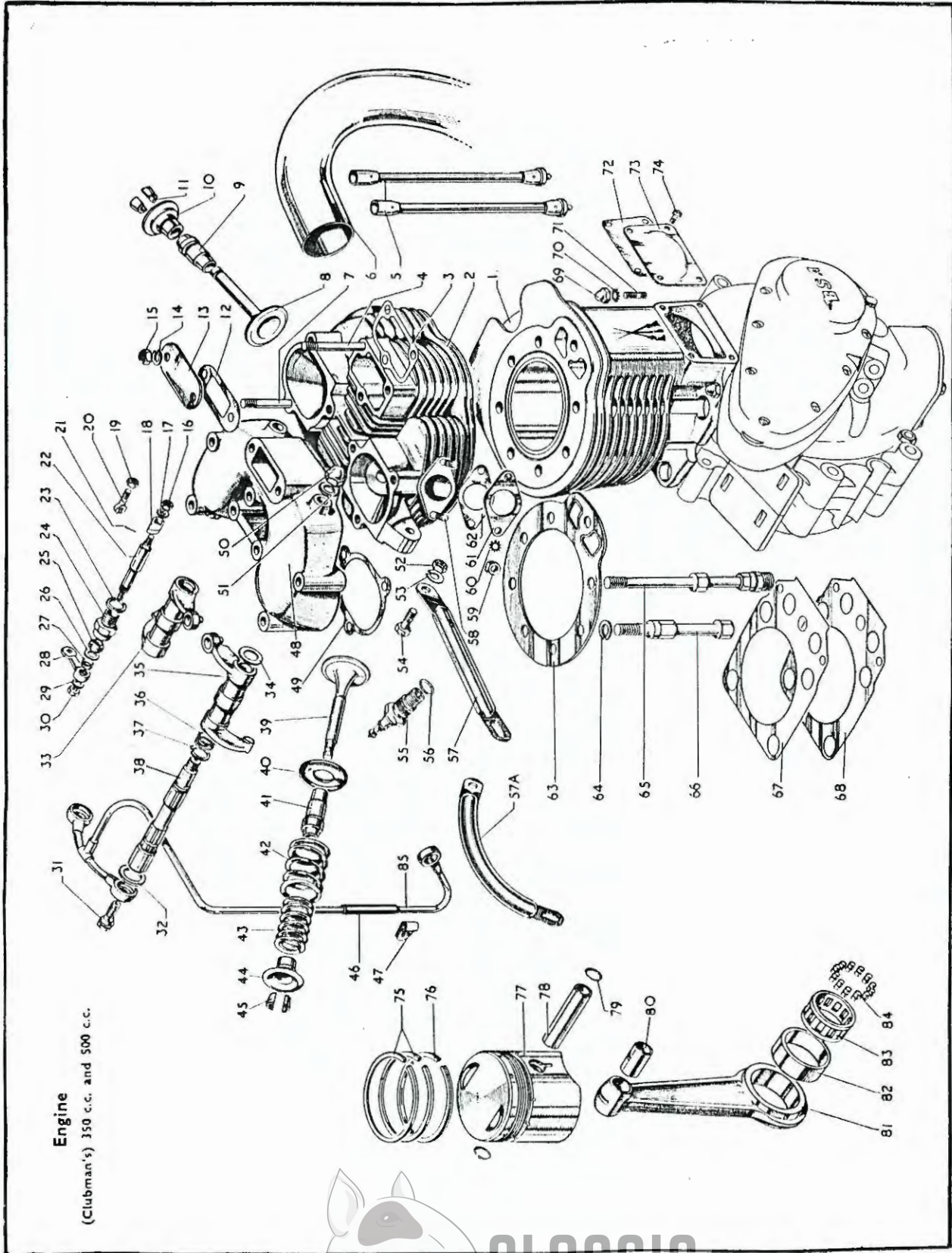

Plate 3—continued

ENGINE.

Gold Star (Clubman's) 350c.c. and 500c.c.

Plate Ref. Number.	Models.	Part No.	Description.	Number per set.
8	Gold Star Clubmans 500 c.c.	65-1646	Exhaust valve...	1
	Gold Star Clubmans 350 c.c.	65-1644	Exhaust valve...	1
9	Gold Star Clubmans 500 c.c.	65-1598	Valve guide (exhaust)	1
	Gold Star Clubmans 350 c.c.	65-1512	Valve guide (exhaust)	1
10	Gold Star Clubmans 500 c.c.	65-1629	Valve spring collar (exhaust)	1
	Gold Star Clubmans 350 c.c.	65-1627	Valve spring collar (exhaust)	1
11	Gold Star Clubmans 500 c.c.	65-1625	Valve spring split cotter (exhaust) (halves)	2
	Gold Star Clubmans 350 c.c.	65-1626	Valve spring split cotter (exhaust) (halves)	2
12	Gold Star Clubmans	65-1590	Rocker box inspection cover joint washer	1
13	Gold Star Clubmans	65-1589	Rocker box inspection cover	1
14	Gold Star Clubmans	24-8784	Rocker box stud nut washer	9
15	Gold Star Clubmans	2-49	Rocker box stud nut	9
16	Gold Star Clubmans	2-443	Exhaust lifter spindle nut	1
17	Gold Star Clubmans	2-525	Exhaust lifter washer	1
18	Gold Star Clubmans	65-1137	Exhaust lifter	1
19	Gold Star Clubmans	2-443	Exhaust lifter cable holder nut	1
20	Gold Star Clubmans	27-1163	Exhaust lifter cable holder	1
21	Gold Star Clubmans	35-701	Exhaust lifter split pin	1
22	Gold Star Clubmans	65-1165	Exhaust lifter spindle	1
23	Gold Star Clubmans	2-2894	Exhaust lifter spindle washer (fibre)	1
24	Gold Star Clubmans	65-387	Exhaust lifter bush	1
25	Gold Star Clubmans	65-401	Exhaust lifter spindle washer (felt)	1
26	Gold Star Clubmans	65-402	Exhaust lifter spindle washer	1
27	Gold Star Clubmans	65-403	Exhaust lifter spindle spring	1
28	Gold Star Clubmans	66-1431	Exhaust lifter lever	1
29	Gold Star Clubmans	2-525	Exhaust lifter washer	1
30	Gold Star Clubmans	2-443	Exhaust lifter spindle nut	1
31	Gold Star Clubmans	65-317	Rocker oil feed banjo screw	2
32	Gold Star Clubmans	31-8430	Rocker oil feed pipe banjo washer (fibre)	1
33	Gold Star Clubmans	65-1318	Valve rocker (exhaust)	1
34	Gold Star Clubmans	27-1111	Valve rocker fulcrum pin thrust washer	2
35	Gold Star Clubmans	65-1316	Valve rocker (inlet)	1
36	Gold Star Clubmans	65-1117	Valve rocker fulcrum pin spring	2
37	Gold Star Clubmans	65-1118	Valve rocker fulcrum pin washer	2
38	Gold Star Clubmans	65-1320	Valve rocker fulcrum pin	2
39	Gold Star Clubmans 500 c.c.	65-1632	Valve (inlet)	1
	Gold Star Clubmans 350 c.c.	65-1611	Valve (inlet)	1
40	Gold Star Clubmans	65-1519	Valve spring seat	2
41	Gold Star Clubmans 500 c.c.	65-1597	Valve guide (inlet)	1
	Gold Star Clubmans 350 c.c.	65-1511	Valve guide (inlet)	1
42	Gold Star Clubmans	65-1249	Valve spring (outer)	2
43	Gold Star Clubmans	65-1259	Valve spring (inner)	2
44	Gold Star Clubmans 500 c.c.	65-1627	Valve spring collar (inlet)	1
	Gold Star Clubmans 350 c.c.	65-1628	Valve spring collar (inlet)	1
45	Gold Star Clubmans 500 c.c.	65-1626	Valve spring split cotter (inlet) (halves)	2
	Gold Star Clubmans 350 c.c.	65-1624	Valve spring split cotter (inlet) (halves)	2
46	Gold Star Clubmans	66-8338	Rocker oil feed pipe connection (rubber)	1
47	Gold Star Clubmans	65-1366	Rocker spindle oil feed pipe clip	1
48	Gold Star Clubmans	65-1506	Rocker box	1
49	Gold Star Clubmans	65-1588	Rocker box joint washer	2
50	Gold Star Clubmans	65-311	Valve rocker fulcrum pin nut	2
51	Gold Star Clubmans	36-481	Valve rocker fulcrum pin washer	2
52	Gold Star Clubmans	2-49	Engine steady stay bolt nut	1
53	Gold Star Clubmans	24-8784	Engine steady stay bolt washer	1
54	Gold Star Clubmans	15-480	Engine steady stay bolt	1



Plate 3—continued

ENGINE

Gold Star (Clubman's) 350c.c. and 500c.c.

Plate Ref. Number.	Models.	Part No.	Description.	Number per set.
55	Gold Star Clubmans 500 c.c.	65-1339	Sparkling plug	1
	Gold Star Clubmans 350 c.c.	65-1341	Sparkling plug	1
56	Gold Star Clubmans	66-102	Sparkling plug washer	1
57	Gold Star Clubmans	65-1153	Engine steady stay	1
57A	Gold Star Clubmans 500 c.c.	65-1433	Engine steady stay (for use with twin top feed T.T. carburetter)	1
58	Gold Star Clubmans	29-565	Carburetter stud	2
59	Gold Star Clubmans	2-49	Carburetter stud nut	2
60	Gold Star Clubmans	36-382	Carburetter stud nut washer	2
61	Gold Star Clubmans 500 c.c.	65-1418	Carburetter flange washer (Tufnol)	2
	Gold Star Clubmans 350 c.c.	67-933	Carburetter flange washer (Tufnol)	1
62	Gold Star Clubmans 500 c.c.	65-1417	Carburetter flange washer (paper)	2
	Gold Star Clubmans 350 c.c.	65-1162	Carburetter flange washer (paper)	2
63	Gold Star Clubmans 500 c.c.	65-1580	Cylinder head gasket...	1
	Gold Star Clubmans 350 c.c.	65-1606	Cylinder head gasket...	1
64	Gold Star Clubmans 500 c.c.	3-110	Cylinder head bolt washer	4
	Gold Star Clubmans 350 c.c.	2-2903	Cylinder head bolt washer	4
65	Gold Star Clubmans 500 c.c.	65-1403	Cylinder and head holding down bolt	4
	Gold Star Clubmans 350 c.c.	65-1609	Cylinder holding down bolt	4
66	Gold Star Clubmans 500 c.c.	65-1413	Cylinder head bolt (medium)	4
	Gold Star Clubmans 350 c.c.	66-134	Cylinder head and barrel bolt	4
67	Gold Star Clubmans	65-1650	Cylinder base shim (.010")	—
	Gold Star Clubmans	65-1651	Cylinder base shim (.020")	—
	Gold Star Clubmans	65-1652	Cylinder base shim (.030")	—
	Gold Star Clubmans	65-1653	Cylinder base shim (.064")	—
68	Gold Star Clubmans	65-1582	Cylinder base washer	1
69	Gold Star Clubmans	65-930	Cylinder barrel stud nut	2
70	Gold Star Clubmans	29-541	Cylinder barrel stud nut washer	2
71	Gold Star Clubmans	24-4227	Cylinder barrel stud	2
72	Gold Star Clubmans	66-1937	Push rod tappet recess cover joint washer	1
73	Gold Star Clubmans	66-1936	Push rod tappet recess cover	1
74	Gold Star Clubmans	29-2158	Push rod tappet recess cover screw	4
75	Gold Star Clubmans 500 c.c.	65-1453	Compression ring	2
	Gold Star Clubmans 350 c.c.	65-1621	Compression ring	2
76	Gold Star Clubmans 500 c.c.	65-1253	Scraper ring	1
	Gold Star Clubmans 350 c.c.	65-490	Scraper ring	1
77	Gold Star Clubmans 350 c.c.	65-1615	Piston complete with gudgeon pin, rings and circlips (Standard) (c.r. 7.5 to 1)	1
	Gold Star Clubmans 500 c.c.	65-1467	Piston complete with gudgeon pin, rings and circlips (Standard) (c.r. 7.5 to 1)	1
78	Gold Star Clubmans 500 c.c.	66-953	Gudgeon pin	1
	Gold Star Clubmans 350 c.c.	65-440	Gudgeon pin	1
79	Gold Star Clubmans	66-954	Gudgeon pin retaining ring	2
80	Gold Star Clubmans	66-492	Gudgeon pin bush	1



Plate 3—continued

ENGINE

Gold Star (Clubman's) 350c.c. and 500c.c.

Plate Ref. Number.	Models.	Part No.	Description.	Number per set.
81	Gold Star Clubmans			
...	500 c.c.	65-1321	Connecting rod complete with bushes	1
...	Gold Star Clubmans			
...	350 c.c.	65-1613	Connecting rod complete with bushes	1
82	Gold Star Clubmans	66-490	Connecting rod big-end bush	1
83	Gold Star Clubmans	66-506	Crankpin roller cage	1
84	Gold Star Clubmans	24-375	Crankpin roller	24
85	Gold Star Clubmans	65-1554	Rocker oil seal pipe with rubber connection	1

Plate 4

ENGINE

Gold Star (Clubman's) 350c.c. and 500c.c.

Plate Ref. Number	Models.	Part No.	Description.	Number per set.
1	Gold Star Clubmans	65-2188	Oil valve spring retaining screw	1
2	Gold Star Clubmans	66-1683	Oil valve spring retaining screw washer (fibre)	1
3	Gold Star Clubmans	66-1684	Oil valve spring	1
4	Gold Star Clubmans	1" diam.	Oil valve spring ball	1
5	Gold Star Clubmans	65-2157	Timing cover screw	9
6	Gold Star Clubmans			
...	350 c.c.	65-1435	Timing cover complete	1
...	Gold Star Clubmans			
...	500 c.c.	65-2143	Timing cover complete	1
7	Gold Star Clubmans	65-2166	Timing cover breather extension pipe	1
8	Gold Star Clubmans	15-8434	Timing cover breather extension pipe nut	1
9	Gold Star Clubmans	65-2165	Air release body	1
10	Gold Star Clubmans	65-2171	Air release adaptor screw	1
11	Gold Star Clubmans	15-82	Air release disc	1
12	Gold Star Clubmans	65-2168	Timing cover air release adaptor complete	1
13	Gold Star Clubmans	31-8430	Air release adaptor washer (fibre)	1
14	Gold Star Clubmans	66-2007	Cam pinion spindle bolt	2
15	Gold Star Clubmans	66-1923	Oil feed washer (rubber)	2
16	Gold Star Clubmans	36-382	Cam pinion spindle bolt washer (shakeproof)	2
17	Gold Star Clubmans	66-698	Engine shaft oil feed pipe	1
18	Gold Star Clubmans	29-905	Engine shaft timing pinion nut	1
19	Gold Star Clubmans	65-695	Engine shaft timing pinion locking washer	1
20	Gold Star Clubmans	66-2008	Timing gear plate complete	1
21	Gold Star Clubmans	21-2902	Timing gear plate bolt	3
22	Gold Star Clubmans	36-382	Timing gear plate bolt washer (shakeproof)	3
23	Gold Star Clubmans	1-5069	Timing gear plate bolt	1
24	Gold Star Clubmans	36-382	Timing gear plate bolt washer (shakeproof)	1
25	Gold Star Clubmans	66-2250	Magdyno drive idler pinion	1
26	Gold Star Clubmans	24-195	Magdyno driving pinion nut	1
27	Gold Star Clubmans	2-2903	Magdyno driving pinion washer (spring)	1
28	Gold Star Clubmans	65-2334	Magdyno driving pinion	1
29	Gold Star Clubmans	65-2316	Magdyno driving pinion oil seal	1
30	Gold Star Clubmans	7/32"	Oil pump valve body ball	1
31	Gold Star Clubmans	65-2622	Oil pump valve body ball circlip	1
32	Gold Star Clubmans	65-2619	Oil pump complete	1
33	Gold Star Clubmans	65-2604	Oil pump fixing bolt	2
34	Gold Star Clubmans	15-848	Oil pump bolt	2
35	Gold Star Clubmans	24-978	Oil pump fixing bolt washer	2
36	Gold Star Clubmans	65-2625	Oil pump bottom plate	1
37	Gold Star Clubmans	65-2599	Oil pump scavenge gear	1
38	Gold Star Clubmans	65-2596	Oil pump body	1
39	Gold Star Clubmans	65-2600	Oil pump feed gear (driven)	1
40	Gold Star Clubmans	65-2601	Oil pump feed gear (driver)	1
41	Gold Star Clubmans	65-2606	Oil pump top plate washer	1

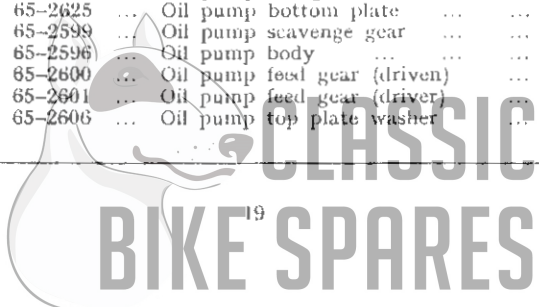

ENGINE
Gold Star (Clubman's) 350c.c. and 500c.c.

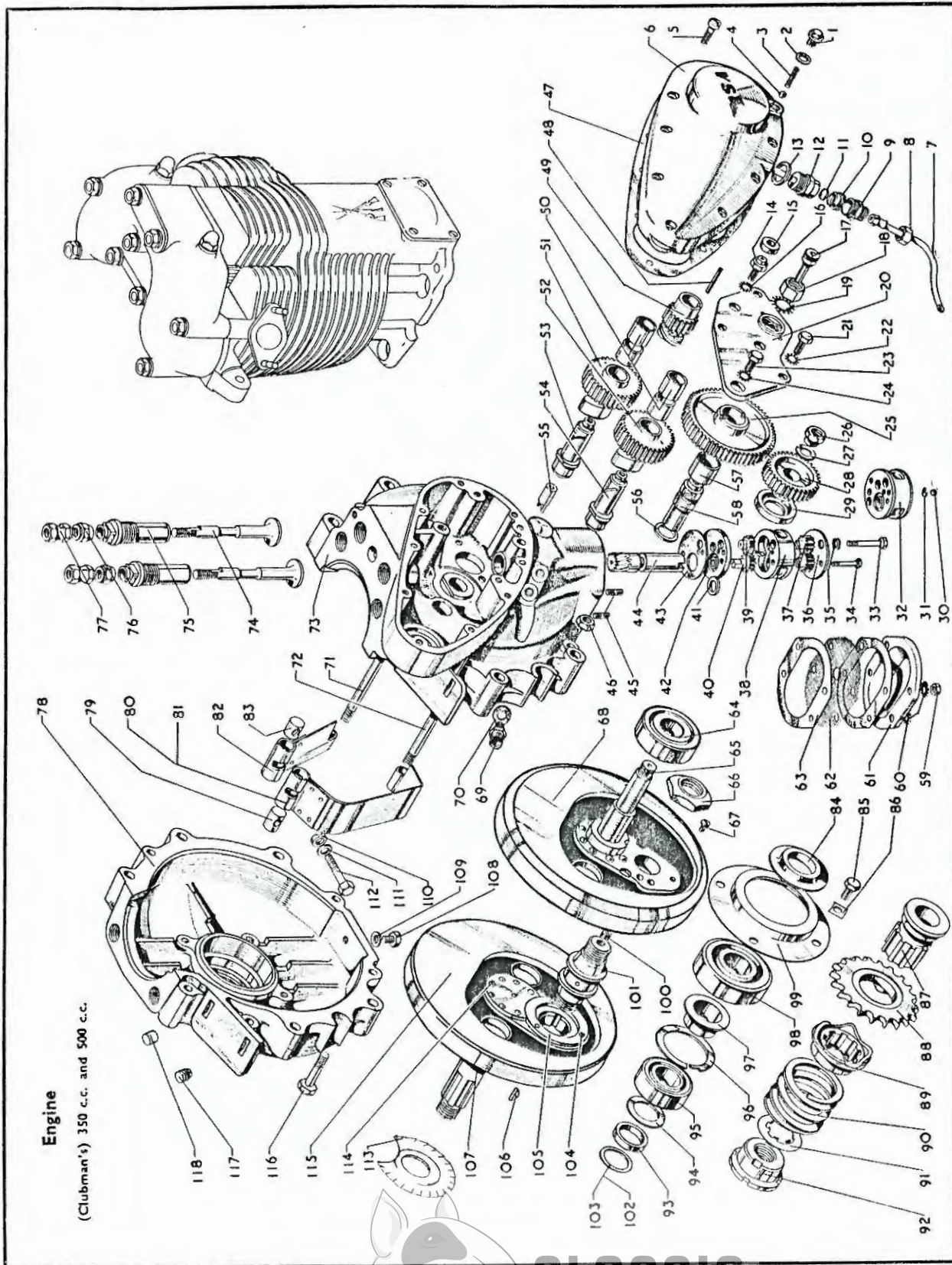

Engine

(Clubman's) 350 c.c. and 500 c.c.

Plate 4 - continued

ENGINE

Gold Star (Clubman's) 350c.c. and 500c.c.

Plate Ref. Number.	Models.	Part No.	Description.	Number per set.
42	... Gold Star Clubmans ...	65-2598	Oil pump top plate ...	1
43	... Gold Star Clubmans ...	65-2618	Oil pump and crankcase joint washer ...	1
44	... Gold Star Clubmans ...	66-2620	Oil pump driving spindle ...	1
45	... Gold Star Clubmans ...	31-222	Crankcase scavenge cover stud ...	4
46	... Gold Star Clubmans ...	2-49	Crankcase connecting bolt nut ...	5
47	... Gold Star Clubmans ...	66-1920	Timing cover washer ...	1
48	... Gold Star Clubmans ...	65-693	Engine shaft timing pinion key ...	1
49	... Gold Star Clubmans ...	65-692	Engine shaft timing pinion ...	1
50	... Gold Star Clubmans ...	65-441	Cam pinion bush ...	4
51	... Gold Star Clubmans 350 c.c. ...	65-2446	Exhaust cam pinion complete ...	1
	... Gold Star Clubmans 500 c.c. ...	65-1348	Exhaust cam pinion complete (when megaphone is fitted) ...	1
	... Gold Star Clubmans 500 c.c. ...	65-2436	Exhaust cam pinion complete ...	1
52	... Gold Star Clubmans 350 c.c. ...	65-2444	Inlet cam pinion complete ...	1
	... Gold Star Clubmans 500 c.c. ...	65-1346	Inlet cam pinion complete (when megaphone is fitted) ...	1
	... Gold Star Clubmans 500 c.c. ...	65-2438	Inlet cam pinion complete ...	1
53	... Gold Star Clubmans ...	65-2426	Cam pinion spindle (exhaust) ...	1
54	... Gold Star Clubmans ...	65-2425	Cam pinion spindle (inlet) ...	1
55	... Gold Star Clubmans ...	65-2580	Oil pump driving spindle retaining pin ...	1
56	... Gold Star Clubmans ...	36-3528	Magdyno drive idler pinion thrust washer ...	1
57	... Gold Star Clubmans ...	65-2336	Magdyno drive idler pinion bush ...	1
58	... Gold Star Clubmans ...	65-2335	Magdyno drive idler pinion spindle ...	1
59	... Gold Star Clubmans ...	2-51	Crankcase scavenge cover stud nut ...	4
60	... Gold Star Clubmans ...	29-541	Crankcase scavenge cover washer (shakeproof) ...	4
61	... Gold Star Clubmans ...	65-2611	Crankcase scavenge cover ...	1
62	... Gold Star Clubmans ...	65-2623	Oil pump filter ...	1
63	... Gold Star Clubmans ...	65-2612	Crankcase scavenge cover washer (oil proof) ...	2
64	... Gold Star Clubmans ...	24-722	Roller bearing (gearside) ...	1
65	... Gold Star Clubmans ...	65-1129	Engine shaft (gearside) ...	1
66	... Gold Star Clubmans ...	65-1327	Crankpin nut ...	2
67	... Gold Star Clubmans ...	2-77	Crankpin locking screw ...	2
68	... Gold Star Clubmans 350 c.c. ...	65-1325	Flywheel with engine shaft assembly (gearside) ...	1
	... Gold Star Clubmans 500 c.c. ...	65-1358	Flywheel with engine shaft assembly (gearside) ...	1
69	... Gold Star Clubmans ...	65-2252	Oil pipe crankcase pipe adaptor ...	1
70	... Gold Star Clubmans ...	66-1683	Oil pipe crankcase pipe adaptor washer (fibre) ...	2
71	... Gold Star Clubmans ...	31-212	Crankcase stud (top) (rear) ...	1
72	... Gold Star Clubmans ...	24-949	Crankcase stud (rear) ...	1
73	... Gold Star Clubmans 350 c.c. ...	66-1650	Crankcase with fixed fittings (gearside) ...	1
	... Gold Star Clubmans 500 c.c. ...	66-1648	Crankcase with fixed fittings (gearside) ...	1
74	... Gold Star Clubmans ...	65-1526	Inlet and exhaust tappet ...	2
75	... Gold Star Clubmans ...	66-1494	Tappet guide (inlet and exhaust) ...	2
76	... Gold Star Clubmans ...	65-1332	Inlet and exhaust tappet locknut ...	2
77	... Gold Star Clubmans ...	66-1511	Inlet and exhaust tappet head ...	2
78	... Gold Star Clubmans 350 c.c. ...	66-1652	Crankcase with fixed fittings (drive side) ...	1
	... Gold Star Clubmans 500 c.c. ...	66-1654	Crankcase with fixed fittings (drive side) ...	1
79	... Gold Star Clubmans 500 c.c. ...	65-2352	Strap eye plug (plain) ...	1
	... Gold Star Clubmans 350 c.c. ...	65-2352	Eye plug (plain) ...	1
80	... Gold Star Clubmans ...	65-1427	Magdyno strap (long) ...	1
81	... Gold Star Clubmans 500 c.c. ...	65-1423	Magneto strap (long) ...	1
82	... Gold Star Clubmans 500 c.c. ...	65-1425	Magdyno and magneto strap (short) ...	1
83	... Gold Star Clubmans ...	65-2353	Eye plug (tapped) ...	1
	... Gold Star Clubmans 500 c.c. ...	65-2353	Strap eye plug (tapped) ...	1
84	... Gold Star Clubmans 350 c.c. ...	66-660	Engine shaft distance collar (inner) (drive side) ...	1

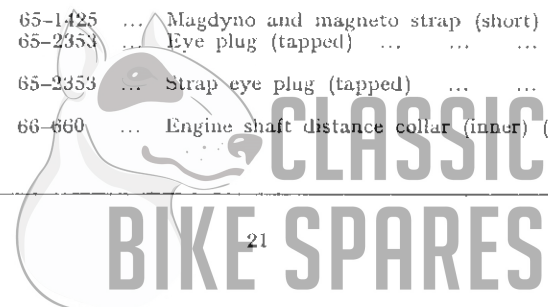

ENGINE

Gold Star (Clubman's) 350c.c. and 500c.c.

Plate Ref. Number.	Models.	Part No.	Description.	Number per set.
	Gold Star Clubmans 500 c.c.	65-1398	Engine shaft distance collar (inner) (drive side)	1
85	Gold Star Clubmans 500 c.c.	31-426	Bearing retaining plate bolt	4
86	Gold Star Clubmans 500 c.c.	65-1438	Bearing retaining plate lockwasher	4
87	Gold Star Clubmans	65-2523	Cush drive bearing	1
88	Gold Star Clubmans 500 c.c.	15-1564	Engine sprocket (20T)	1
	Gold Star Clubmans 500 c.c.	15-1567	Engine sprocket (17T)	1
	Gold Star Clubmans 350 c.c.	15-1566	Engine sprocket (18T)	1
89	Gold Star Clubmans	15-1555	Cush drive sleeve	1
90	Gold Star Clubmans	66-1706	Cush drive spring	1
91	Gold Star Clubmans	65-2521	Cush drive bearing locking washer	1
92	Gold Star Clubmans	65-2520	Cush drive bearing nut	1
93	Gold Star Clubmans	65-2528	Cush drive distance piece	1
	Gold Star Clubmans	65-2529	Cush drive distance piece	1
	Gold Star Clubmans	65-2530	Cush drive distance piece	1
94	Gold Star Clubmans	66-661	Engine shaft shim (drive side)	1
95	Gold Star Clubmans	65-2045	Ball bearing (drive side)	1
96	Gold Star Clubmans	65-2240	Main bearing spring ring	1
97	Gold Star Clubmans 500 c.c.	65-1396	Engine shaft distance collar (outer)	1
98	Gold Star Clubmans 350 c.c.	24-724	Roller bearing (drive side)	1
	Gold Star Clubmans 500 c.c.	65-1388	Roller bearing (drive side)	1
99	Gold Star Clubmans 500 c.c.	65-1397	Bearing retaining plate	1
100	Gold Star Clubmans	65-479	Crankpin plug screw	1
101	Gold Star Clubmans	66-262	Crankpin	1
102	Gold Star Clubmans	66-1708	Cush drive bearing alignment washer (.064")	1
103	Gold Star Clubmans	66-1707	Cush drive bearing alignment washer (.032")	1
104	Gold Star Clubmans	66-630	Connecting rod thrust washer rivet	6
105	Gold Star Clubmans	66-629	Connecting rod thrust washer	2
106	Gold Star Clubmans	2-36	Crankpin key	1
107	Gold Star Clubmans 350 c.c.	65-1128	Engine shaft (drive side)	1
	Gold Star Clubmans 500 c.c.	65-1412	Engine shaft (drive side)	1
108	Gold Star Clubmans	28-243	Crankcase drain plug	1
109	Gold Star Clubmans	2-4553	Crankcase drain plug washer (fibre)	1
110	Gold Star Clubmans	29-4662	Saddle washer (magneto or magdyno strap)	1
111	Gold Star Clubmans	2-923	Strap clip bolt washer (plain)	1
112	Gold Star Clubmans	29-4661	Strap clip bolt	1
113	Gold Star Clubmans 350 c.c.	65-1330	Oil flinger	1
114	Gold Star Clubmans	27-1239	Engine shaft rivet	14
115	Gold Star Clubmans 350 c.c.	65-1323	Flywheel with engine shaft assembled (drive side)	1
	Gold Star Clubmans 500 c.c.	65-1406	Flywheel with engine shaft assembled (drive side)	1
116	Gold Star Clubmans	15-1355	Crankcase connecting bolt	3
117	Gold Star Clubmans 500 c.c.	66-1717	Magneto dowel (B.T.H.)	4
118	Gold Star Clubmans 500 c.c.	66-2313	Magneto dowel (Lucas)	4

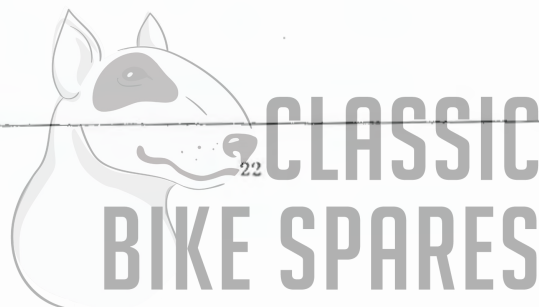

Plate 5

GEARBOX

"B" Group and Gold Star (Clubman's) 350c.c. and 500c.c.

Plate Ref. Number.	Models.	Part No.	Description.	Number per set.
1	B31 B32 B33 B34 and Gold Star Clubmans	29-3250	Operating pedal spindle rubber	1
2	Gold Star Clubmans	67-3171	Gear change operating lever	1
3	B31 B32 B33 B34 and Gold Star Clubmans	65-3361	Footchange operating pedal clamp bolt	1
4	B31 B32 B33 B34 and Gold Star Clubmans	2-525	Footchange operating pedal clamp bolt washer	1
5	B31 B32 B33 B34 and Gold Star Clubmans	15-4240	Operating shaft clip ring	1
6	B31 B32 B33 B34 and Gold Star Clubmans	28-2080	Gearbox outer cover grease nipple	1
7	B31 B32 B33 B34 and Gold Star Clubmans	66-3065	Gearbox outer and inner cover screw	3
8	B32 B34 and Gold Star Clubmans	65-3397	Kickstarter crank rubber	1
9	B32 B34 and Gold Star Clubmans	65-3427	Kickstarter crank pedal	1
10	B32 B34 and Gold Star Clubmans	66-4707	Kickstarter pedal bolt washer	1
11	B31 B32 B33 B34 and Gold Star Clubmans	29-5156	Kickstarter pedal bolt	1
12	B31 B32 B33 B34 and Gold Star Clubmans	35-702	Clutch control lever split pin	1
13	B31 B32 B33 B34 and Gold Star Clubmans	15-1485	Clutch control lever nut	1
14	B31 B32 B33 B34 and Gold Star Clubmans	3-720	Clutch push rod lever adjusting screw nut	1
15	B31 B32 B33 B34 and Gold Star Clubmans	65-3403	Clutch push rod lever adjusting screw	1
16	B31 B32 B33 B34 and Gold Star Clubmans	2-525	Clutch control lever nut washer	1
17	B31 B32 B33 B34 and Gold Star Clubmans	65-3360	Clutch push rod lever	1
18	B31 B32 B33 B34 and Gold Star Clubmans	65-3383	Clutch control lever	1
19	B31 B32 B33 B34 and Gold Star Clubmans	2-2395	Pawl pivot locknut	2
20	B31 B32 B33 B34 and Gold Star Clubmans	2-2395	Pawl pivot locknut	1
21	B31 B32 B33 B34 and Gold Star Clubmans	15-4143	Pawl pivot nut	2
22	B31 B32 B33 B34 and Gold Star Clubmans	15-4143	Pawl pivot nut	1
23	B31 B32 B33 B34 and Gold Star Clubmans	2-443	Pawl pivot locknut	1
24	B31 B32 B33 B34 and Gold Star Clubmans	65-3455	Pawl pivot nut (thin)	1
25	B31 B32 B33 B34 and Gold Star Clubmans	15-4142	Pawl (bottom)	1
26	B31 B32 B33 B34 and Gold Star Clubmans	15-4141	Pawl (top)	1
27	B31 B32 B33 B34 and Gold Star Clubmans	15-4161	Pawl return spring	1
28	B31 B32 B33 B34 and Gold Star Clubmans	15-4249	Pawl carrier arm (top), complete with washers	1
29	B31 B32 B33 B34 and Gold Star Clubmans	15-4237	Pawl carrier arm (bottom)	1
30	B31 B32 B33 B34 and Gold Star Clubmans	15-4138	Pawl pivot	2
31	B31 B32 B33 B34 and Gold Star Clubmans	65-3454	Pawl pivot for thin nut	1
32	B31 B32 B33 B34 and Gold Star Clubmans	2-2211	Operating plate and pawl arm stop screw	2
33	B31 B32 B33 B34 and Gold Star Clubmans	15-4139	Pawl carrier arm main spring	1
34	B31 B32 B33 B34 and Gold Star Clubmans	15-4229	Operating shaft	1
35	B31 B32 B33 B34 and Gold Star Clubmans	15-4228	Operating plate and pawl arm stop	1
36	B31 B32 B33 B34 and Gold Star Clubmans	36-382	Operating plate and pawl arm stop washer	2
37	B31 B32 B33 B34 and Gold Star Clubmans	2-49	Operating plate and pawl arm stop screw nut	2
38	B31 B32 B33 B34 and Gold Star Clubmans	15-4231	Operating plate	1
39	B31 B32 B33 B34 and Gold Star Clubmans	2-440	Operating shaft nut	1

Gearbox

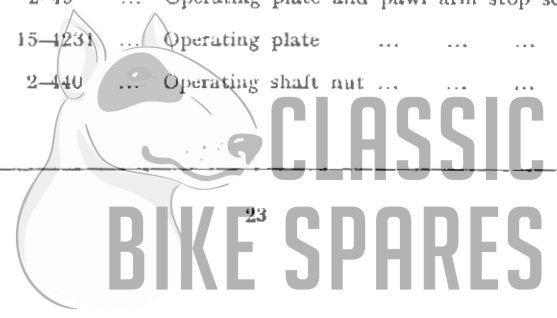

GEARBOX

"B" Group and Gold Star (Clubman's) 350c.c. and 500c.c.

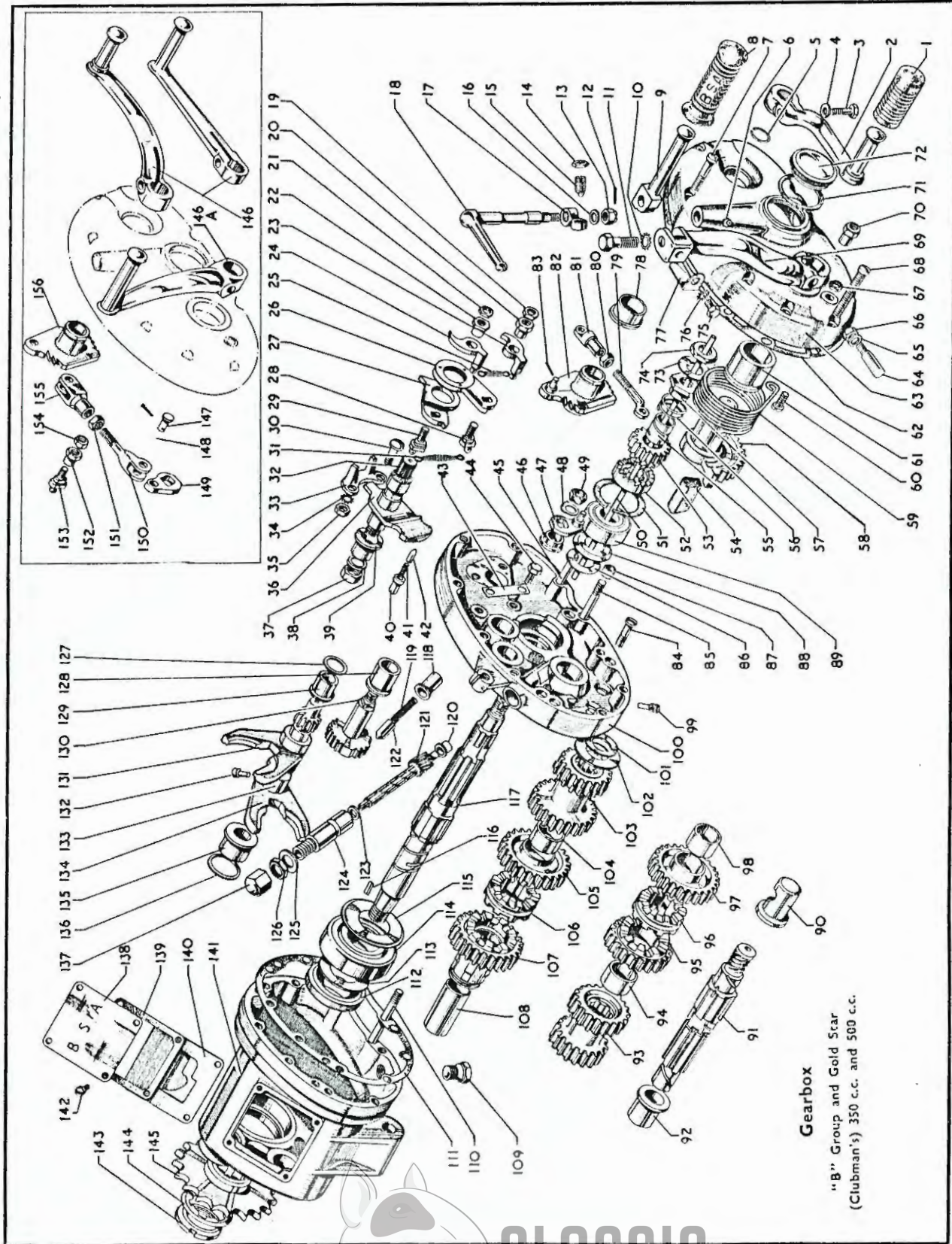

Gearbox
"B" Group and Gold Star
(Clubman's) 350 c.c. and 500 c.c.

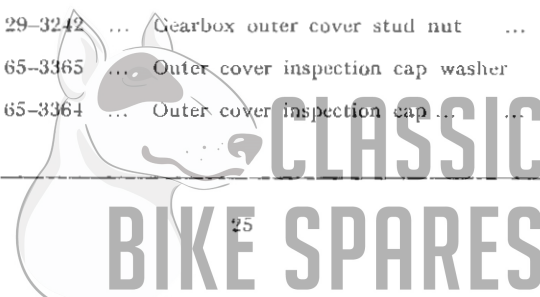

Plate 5—continued

GEARBOX

"B" Group and Gold Star (Clubman's) 350c.c. and 500c.c.

Plate Ref. Number.	Models.	Part No.	Description.	Number per set.
38	B31 B32 B33 B34 and Gold Star Clubmans	15-39	Operating shaft washer	1
39	B31 B32 B33 B34 and Gold Star Clubmans	15-4226	Pedal shaft bush	1
40	B31 B32 B33 B34 and Gold Star Clubmans	15-4223	Indexing plunger sleeve	1
41	B31 B32 B33 B34 and Gold Star Clubmans	15-4225	Indexing plunger spring	1
42	B31 B32 B33 B34 and Gold Star Clubmans	15-4224	Operating plate indexing plunger	1
43	B31 B32 B33 B34 and Gold Star Clubmans	15-4246	Inner cover and case locking strip	1
44	B31 B32 B33 B34 and Gold Star Clubmans	21-2888	Gearbox inner cover bolt	2
45	B31 B32 B33 B34 and Gold Star Clubmans	66-1910	Gearbox outer cover stud	1
46	B31 B32 B33 B34 and Gold Star Clubmans	15-4233	Gear control quadrant spacing collar	1
47	B31 B32 B33 B34 and Gold Star Clubmans	65-3450	Gear operating lever complete	1
48	B31 B32 B33 B34 and Gold Star Clubmans	15-4232	Gear operating lever locking washer	1
49	B31 B32 B33 B34 and Gold Star Clubmans	2-1813	Gear operating lever nut	1
50	B31 B32 B33 B34 and Gold Star Clubmans	65-3940	Clutch push rod	1
51	B31 B32 B33 B34 and Gold Star Clubmans	66-3067	Clutch push rod	1
52	B31 B32 B33 B34 and Gold Star Clubmans	67-3028	Gearbox inner cover ball journal spring ring	1
53	B31 B32 B33 B34 and Gold Star Clubmans	66-3079	Kickstarter ratchet	1
54	B31 B32 B33 B34 and Gold Star Clubmans	66-3080	Kickstarter ratchet pinion	1
55	B31 B32 B33 B34 and Gold Star Clubmans	66-3259	Kickstarter return stop rubber	1
56	B31 B32 B33 B34 and Gold Star Clubmans	66-3081	Kickstarter ratchet pinion sleeve	1
57	B31 B32 B33 B34 and Gold Star Clubmans	24-4256	Kickstarter ratchet spring	1
58	B31 B32 B33 B34 and Gold Star Clubmans	24-4282	Kickstarter ratchet pinion sleeve nut	1
59	B31 B32 B33 B34 and Gold Star Clubmans	15-4121	Kickstarter quadrant...	1
60	B31 B32 B33 B34 and Gold Star Clubmans	66-3058	Kickstarter crank spring	1
61	B31 B32 B33 B34 and Gold Star Clubmans	2-3718	Kickstarter crank spring anchor pin	1
62	B31 B32 B33 B34 and Gold Star Clubmans	24-4258	Kickstarter quadrant bush	1
63	B31 B32 B33 B34 and Gold Star Clubmans	66-3131	Outer cover joint washer	1
64	B31 B32 B33 B34 and Gold Star Clubmans	66-3126	Outer cover	1
65	B31 B32 B33 B34 and Gold Star Clubmans	2-2579	Kickstarter crank cotter pin	1
66	B31 B32 B33 B34 and Gold Star Clubmans	15-5155	Kickstarter crank cotter pin washer	1
67	B31 B32 B33 B34 and Gold Star Clubmans	2-2578	Kickstarter crank cotter pin nut	1
68	B31 B32 B33 B34 and Gold Star Clubmans	2-443	Kickstarter crank spring anchor pin nut	1
69	B31 B32 B33 B34 and Gold Star Clubmans	65-3062	Gearbox cover and case screw	4
70	B31 B32 B33 B34 and Gold Star Clubmans	65-3426	Kickstarter crank (folding pedal)	1
71	B31 B32 B33 B34 and Gold Star Clubmans	65-3460	Kickstarter crank (folding pedal)	1
72	B31 B32 B33 B34 and Gold Star Clubmans	29-3242	Gearbox outer cover stud nut	4
		65-3365	Outer cover inspection cap washer	1
		65-3364	Outer cover inspection cap	1



GEARBOX

"B" Group and Gold Star (Clubman's) 350c.c. and 500c.c.

Plate Ref. Number.	Models.	Part No.	Description.	Number per set.
73	B31 B32 B33 B34 and ... Gold Star Clubmans ...	24-4278	Kickstarter ratchet pinion locking washer	1
74	B31 B32 B33 B34 and ... Gold Star Clubmans ...	24-4255	Kickstarter ratchet pinion sleeve locknut	1
75	B32 B34 and ... Gold Star Clubmans ...	2-220	Kickstarter crank spring bolt	1
76	B32 B34 and ... Gold Star Clubmans ...	29-541	Kickstarter crank spring bolt washer	1
77	B32 B34 and ... Gold Star Clubmans ...	65-3428	Kickstarter crank pedal spring	1
78	B31 B32 B33 B34 and ... Gold Star Clubmans ...	15-4227	Ratchet lever sleeve bush	1
79	B31 B32 B33 B34 and ... Gold Star Clubmans ...	65-3453	Gear control link adjuster	1
80	B31 B32 B33 B34 and ... Gold Star Clubmans ...	24-563	Gear control link adjuster locknut	1
81	... Gold Star Clubmans ...	65-3452	Gear control link yoke	1
82	... Gold Star Clubmans ...	65-3448	Ratchet lever complete	1
83	... Gold Star Clubmans ...	66-6257	Gear control link split pin	1
84	B31 B32 B33 B34 and ... Gold Star Clubmans ...	65-2157	Inner cover and case screw...	3
85	B31 B32 B33 B34 and ... Gold Star Clubmans ...	65-3073	Gearbox outer cover stud	1
86	B31 B32 B33 B34 and ... Gold Star Clubmans ...	24-4237	Gearbox distance washer	1
87	B31 B32 B33 B34 and ... Gold Star Clubmans ...	66-3074	Gearbox dowel	2
88	B31 B32 B33 B34 and ... Gold Star Clubmans ...	24-4236	Gearbox retaining washer (small)	1
89	B31 B32 B33 B34 and ... Gold Star Clubmans ...	24-4217	Gearbox inner cover ball journal	1
90	B31 B32 B33 B34 and ... Gold Star Clubmans ...	66-3133	Gearbox layshaft bush (long)	1
	B32 B34 ... Gold Star Clubmans ...	65-3498	Layshaft	1
91	B31 B33 ... Gold Star Clubmans ...	66-3132	Layshaft	1
92	B31 B32 B33 B34 and ... Gold Star Clubmans ...	24-4223	Gearbox layshaft bush (short)	1
	B31 B32 B33 B34 ... Gold Star Clubmans ...	24-4221	Layshaft gear (17T and 20T)	1
93	B31 B32 B33 B34 and ... Gold Star Clubmans ...	66-3220	Layshaft gear (19T and 20T)	1
94	B31 B32 B33 B34 and ... Gold Star Clubmans ...	66-3214	Layshaft gear bush	1
	B31 B32 B33 B34 ... Gold Star Clubmans ...	66-3215	Layshaft gear (25T) with bush	1
95	B31 B32 B33 B34 and ... Gold Star Clubmans ...	66-3266	Layshaft gear (22T) with bush	1
96	B31 B32 B33 B34 and ... Gold Star Clubmans ...	24-4393	Gearbox dog clutch	1
	B31 B32 B33 B34 ... Gold Star Clubmans ...	66-3209	Layshaft gear (29T) with bush	1
97	B31 B32 B33 B34 and ... Gold Star Clubmans ...	65-3441	Layshaft gear (26T) with bush	1
98	B31 B32 B33 B34 and ... Gold Star Clubmans ...	66-3211	Layshaft gear bush	1
99	B31 B32 B33 B34 and ... Gold Star Clubmans ...	65-3400	Speedometer bush retaining pin	1
100	B31 B32 B33 B34 and ... Gold Star Clubmans ...	66-3128	Inner cover complete with fixed fittings	1
	B31 B32 B33 B34 ... Gold Star Clubmans ...	66-3071	Mainshaft packing washer (.005")	—
101	B31 B32 B33 B34 and ... Gold Star Clubmans ...	66-3072	Mainshaft packing washer (.010")	—
102	B31 B32 B33 B34 and ... Gold Star Clubmans ...	24-4235	Gearbox oil flinger washer	1
	B31 B32 B33 B34 ... Gold Star Clubmans ...	24-4231	Mainshaft gear (20T and 16T)	1
103	B31 B32 B33 B34 and ... Gold Star Clubmans ...	65-3436	Mainshaft gear (23T and 19T)	1
104	B31 B32 B33 B34 and ... Gold Star Clubmans ...	66-3214	Mainshaft gear bush	1
105	B31 B32 B33 B34 and ... Gold Star Clubmans ...	66-3212	Mainshaft gear (25T) with bush	1
106	B31 B32 B33 B34 and ... Gold Star Clubmans ...	24-4393	Gearbox dog clutch	1
	B31 B32 B33 B34 ... Gold Star Clubmans ...	15-4165	Pinion sleeve	1
107	B31 B32 B33 B34 and ... Gold Star Clubmans ...	66-3219	Pinion sleeve with bush	1
108	B31 B32 B33 B34 and ... Gold Star Clubmans ...	15-4120	Pinion sleeve bush	1
109	B31 B32 B33 B34 and ... Gold Star Clubmans ...	28-43	Gearbox drain plug	1

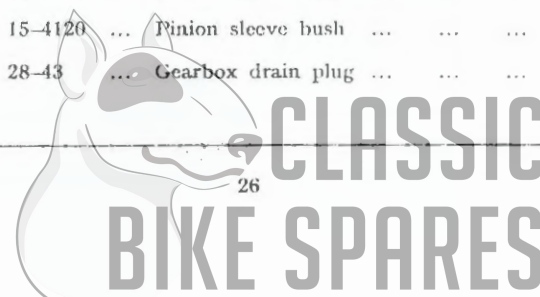
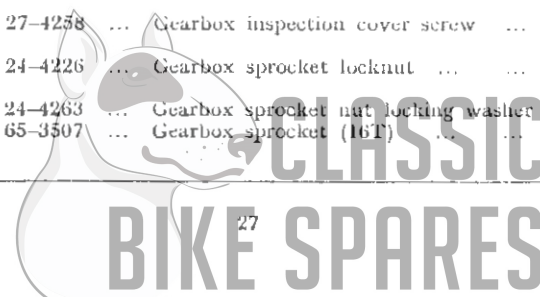

Plate 5—continued

GEARBOX

"B" Group and Gold Star (Clubman's) 350c.c. and 500c.c.

Plate Ref. Number.	Models.	Part No.	Description.	Number per set.
110	B31 B32 B33 B34 and Gold Star Clubmans	29-3304	Gearbox outer cover stud (long)	2
111	B31 B32 B33 B34 and Gold Star Clubmans	66-3069	Inner joint washer	1
112	B31 B32 B33 B34 and Gold Star Clubmans	65-3508	Gearbox sprocket oil seal	1
113	B31 B32 B33 B34 and Gold Star Clubmans	65-3509	Gearbox sprocket oil seal washer	1
114	B31 B32 B33 B34 and Gold Star Clubmans	24-4065	Gearbox ballrace journal	1
115	B31 B32 B33 B34 and Gold Star Clubmans	24-4225	Gearbox oil retaining washer	1
116	B31 B32 B33 B34 and Gold Star Clubmans	2-433	Gearbox key (mainshaft)	1
117	B31 B32 B33 B34 and Gold Star Clubmans	15-4260	Gearbox mainshaft	1
118	B31 B32 B33 B34 and Gold Star Clubmans	24-4251	Gear control plunger cup	1
119	B31 B32 B33 B34 and Gold Star Clubmans	24-68	Gear control plunger spring	1
120	B32 B34 and Gold Star Clubmans	65-3377	Speedo driven gear bush (small)	1
	B32 B34 and Gold Star Clubmans	65-3402	Speedo driven gear	1
121	B31 B33 and Gold Star Clubmans	65-3367	Speedo driven gear	1
122	B31 B32 B33 B34 and Gold Star Clubmans	15-4035	Gear control plunger	1
123	B31 B32 B33 B34 and Gold Star Clubmans	65-3375	Speedo driven gear thrust washer	1
124	B31 B32 B33 B34 and Gold Star Clubmans	65-3390	Speedo driven gear bush	1
125	B31 B32 B33 B34 and Gold Star Clubmans	65-3392	Speedo driven gear bush washer	1
126	B31 B32 B33 B34 and Gold Star Clubmans	65-3391	Speedo driven gear bush nut	1
127	B31 B32 B33 B34 and Gold Star Clubmans	66-3087	Gear control shaft bush packing washer (small)	—
128	B31 B32 B33 B34 and Gold Star Clubmans	24-4248	Gear control quadrant bush	1
129	B31 B32 B33 B34 and Gold Star Clubmans	24-4245	Gear control shaft bush (inner cover)	1
130	B31 B32 B33 B34 and Gold Star Clubmans	24-4247	Gear control quadrant	1
131	B31 B32 B33 B34 and Gold Star Clubmans	66-3290	Gear operating fork	1
132	B31 B32 B33 B34 and Gold Star Clubmans	66-3291	Gear control shaft peg	2
133	B31 B32 B33 B34 and Gold Star Clubmans	66-3083	Gear control shaft	1
134	B31 B32 B33 B34 and Gold Star Clubmans	66-3290	Gear operating fork	1
135	B31 B32 B33 B34 and Gold Star Clubmans	66-3084	Gear control shaft bush	1
136	B31 B32 B33 B34 and Gold Star Clubmans	66-3086	Gear control shaft bush packing washer	—
137	B31 B32 B33 B34 and Gold Star Clubmans	65-3399	Speedo gear bush sealing nut	1
138	B31 B32 B33 B34 and Gold Star Clubmans	66-3070	Gearbox inspection cover	1
139	B31 B32 B33 B34 and Gold Star Clubmans	15-4110	Gearbox inspection cover washer	2
140	B31 B32 B33 B34 and Gold Star Clubmans	24-4288	Gearbox oil baifle	1
141	B31 B32 B33 B34 and Gold Star Clubmans	66-3141	Gearbox shell only	1
142	B31 B32 B33 B34 and Gold Star Clubmans	27-4258	Gearbox inspection cover screw	4
143	B31 B32 B33 B34 and Gold Star Clubmans	24-4226	Gearbox sprocket locknut	1
144	B32 B34 and Gold Star Clubmans	24-4263	Gearbox sprocket nut locking washer	1
	B32 B34 and Gold Star Clubmans	65-3507	Gearbox sprocket (16T)	1



CLASSIC
BIKE SPARES

Plate 5—continued

GEARBOX

"B" Group and Gold Star (Clubman's) 350c.c. and 500c.c.

Plate Ref. Number.	Models.	Part No.	Description.	Number per set.
145	B31 B33 and Gold Star Clubmans B31 B32 B33 B34 and Gold Star Clubmans	65-3506	Gearbox sprocket (19T)	1
	B31 B33	66-3140	Gearbox shell complete with fixed fittings	1
	B32 B34	65-3417	Gearchange operating pedal...	1
146	B32 B34	65-3380	Gearchange operating pedal...	1
146A	B31 B32 B33 B34	65-3381	Kickstart pedal	1
147	B31 B32 B33 B34	15-4221	Gear control link pin	2
148	B31 B32 B33 B34	35-705	Gear control link pin split pin	1
149	B31 B32 B33 B34	15-4239	Gear operating lever	1
150	B31 B32 B33 B34	15-4255	Gear control link adjuster	1
151	B31 B32 B33 B34	24-563	Gear control link adjuster nut	1
152	B31 B32 B33 B34	15-4143	Pawl pivot nut	2
153	B31 B32 B33 B34	15-4138	Pawl pivot	2
154	B31 B32 B33 B34	2-2395	Pawl pivot locknut	2
155	B31 B32 B33 B34	15-4254	Gear control link yoke	1
156	B31 B32 B33 B34	15-4206	Ratchet lever complete	1

Plate 6

CLUTCH and FRONT CHAINCASE

"B" Group and Gold Star (Clubman's) 350c.c. and 500c.c.

Plate Ref. Number.	Models.	Part No.	Description.	Number per set.
1	Gold Star Clubmans B31 B33 B32 B34	65-7591	Front chaincase with fixed fittings	1
	B31 B33	65-7584	Front chaincase with fixed fittings	1
	B32 B34	65-7584	Front chaincase with fixed fittings	1
2	B31 B32 B33 B34 and Gold Star Clubmans B31 B32 B33 B34 and	66-7518	Oil level drain plug washer (fibre)	1
3	Gold Star Clubmans B31 B32 B33 B34 and	66-7517	Oil level plug	1
4	Gold Star Clubmans B31 B32 B33 B34 and	65-3365	Front chaincase inspection cap washer (leather)	1
5	Gold Star Clubmans B31 B32 B33 B34 and	65-3364	Front chaincase inspection cap	1
6	Gold Star Clubmans B31 B32 B33 B34 and	1-4606	Chaincase fixing screw	16
7	Gold Star Clubmans B31 B32 B33 B34 and	29-3319	Chaincase fixing screw washer	16
8	Gold Star Clubmans B31 B32 B33 B34 and	66-7514	Chaincase joint washer (cork)	1
9	Gold Star Clubmans B31 B32 B33 B34 and	2-2395	Clutch spring retaining stud nut	12
10	Gold Star Clubmans B31 B32 B33 B34 and	66-3800	Clutch spring	6
11	Gold Star Clubmans B31 B32 B33 B34 and	66-3781	Clutch spring cup	6
12	Gold Star Clubmans B31 B32 B33 B34 and	65-3828	Clutch actuating cap complete	1
13	Gold Star Clubmans B31 B32 B33 B34 and	66-3787	Mainshaft nut	1
14	Gold Star Clubmans B31 B32 B33 B34 and	65-3822	Mainshaft nut locking washer	1
15	Gold Star Clubmans B31 B32 B33 B34 and	65-3858	Clutch plate ferodo insert	96
	B31	66-3906	Clutch driving plate centre complete with studs	1
16	Gold Star Clubmans B31 B32 B33 B34 and	66-3903	Clutch driving plate centre complete with studs	1
	B31	65-3857	Clutch driving plate complete with inserts	3
17	Gold Star Clubmans B31 B32 B33 B34 and	65-3857	Clutch driving plate complete with inserts	4
	B31	29-3832	Clutch driven plate	1
	B31	65-3824	Clutch driven plate	2
18	B32 B33 B34 and Gold Star Clubmans B31 B32 B33 B34 and	65-3824	Clutch driven plate	4
19	Gold Star Clubmans	65-3911	Clutch ballrace inner ring	1



CLUTCH and FRONT CHAINCASE

"B" Group and Gold Star (Clubman's) 350c.c. and 500c.c.

Clutch and
Front
Chaincase

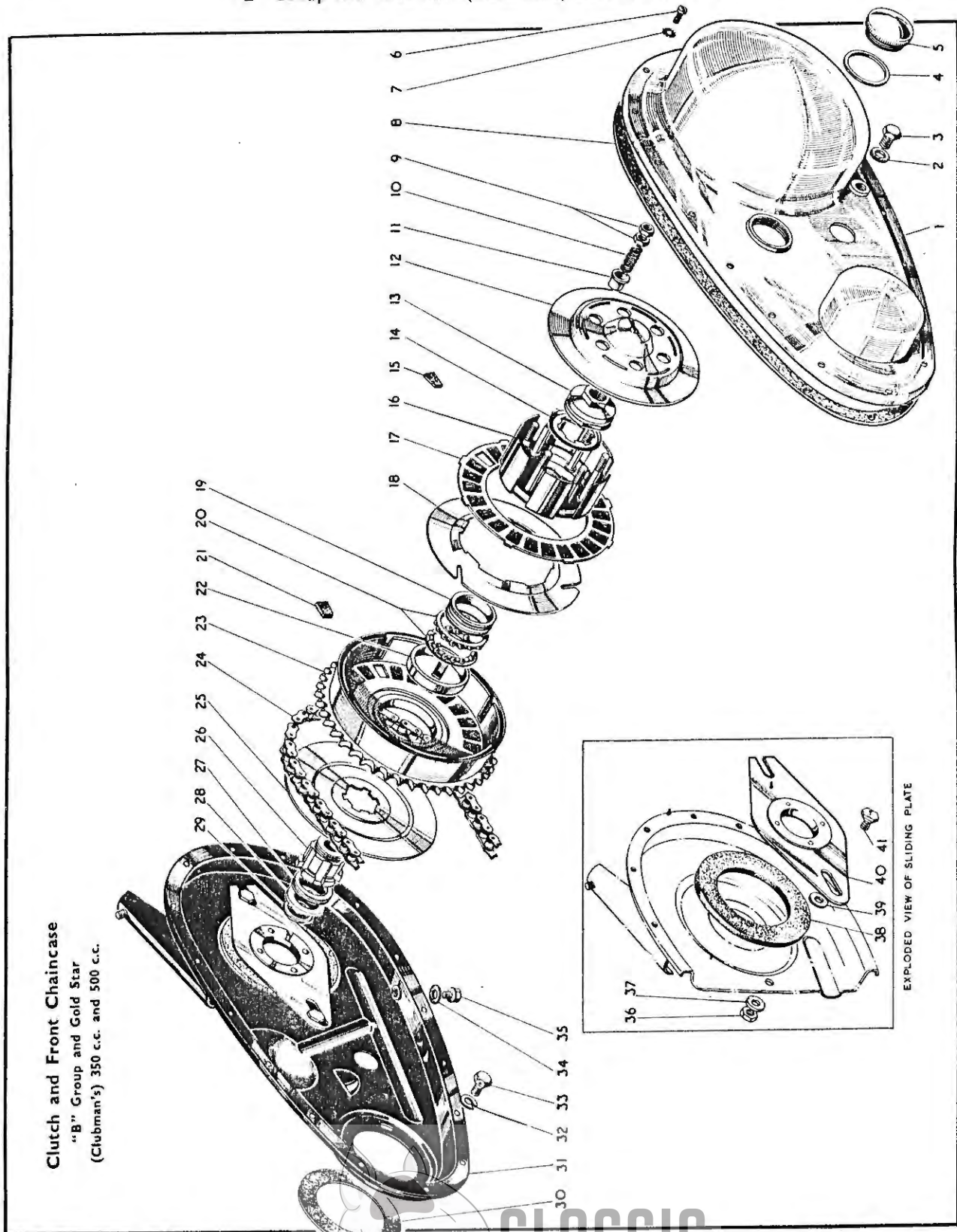

Plate 6—continued

CLUTCH and FRONT CHAINCASE

"B" Group and Gold Star (Clubman's) 350c.c. and 500c.c.

Plate Ref. Number.	Models.	Part No.	Description.	Number per set.
20	B31 B32 B33 B34 and Gold Star Clubmans	65-3910	Clutch ballrace retaining ring complete with balls	2
	B31	65-3811	Clutch chainwheel cork insert	24
21	B32 B33 B34 and Gold Star Clubmans	66-3891	Clutch chainwheel ferodo insert	24
22	B31 B32 B33 B34 and Gold Star Clubmans	65-3912	Clutch ballrace ring	1
	B31	65-3922	Clutch chainwheel complete	1
23	B32 B33 B34 and Gold Star Clubmans	66-3908	Clutch chainwheel complete	1
	B31	24-8931	Transmission chain (front)	1
24	B32 and 350 c.c. Gold Star Clubmans	24-8930	Transmission chain (front)	1
	B33 B34 and 500 c.c. Gold Star Clubmans	24-8932	Transmission chain (front)	1
25	B31 B32 B33 B34 and Gold Star Clubmans	65-3872	Clutch plate	1
26	B31 B32 B33 B34 and Gold Star Clubmans	65-3873	Clutch sleeve	1
27	B31 B32 B33 B34 and Gold Star Clubmans	65-3833	Clutch sleeve collar	1
28	B31 B32 B33 B34 and Gold Star Clubmans	66-3090	Gearbox and chaincase oil retaining washer	1
29	B31 B32 B33 B34 and Gold Star Clubmans	24-4232	Gearbox felt washer	1
30	B31 B32 B33 B34 and Gold Star Clubmans	66-7575	Chaincase and crankcase joint washer (Hallite)	1
	B31 B32 B33 B34	65-7578	Chaincase back with sliding case (spring frame)	1
31	B31 B32 B33 B34 and Gold Star Clubmans	65-7578	Chaincase back with sliding plate	1
	B31 B32 B33 B34	65-7587	Chaincase back with sliding plate (rigid frame)	1
32	B31 B32 B33 B34 and Gold Star Clubmans	24-8784	Chaincase securing bolt spring washer	3
33	B31 B32 B33 B34 and Gold Star Clubmans	65-7550	Chaincase securing bolt	3
34	B31 B32 B33 B34 and Gold Star Clubmans	66-7518	Oil level drain plug washer (fibre)	1
35	B31 B32 B33 B34 and Gold Star Clubmans	15-645	Oil level drain plug	1
36	B31 B32 B33 B34 and Gold Star Clubmans	2-443	Chaincase sliding plate bolt nut	2
37	B31 B32 B33 B34 and Gold Star Clubmans	2-1374	Chaincase sliding plate bolt washer	2
38	B31 B32 B33 B34 and Gold Star Clubmans	15-8814	Chaincase back felt washer	1
39	B31 B32 B33 B34 and Gold Star Clubmans	66-7518	Chaincase sliding plate bolt washer (fibre)	2
40	B31 B32 B33 B34 and Gold Star Clubmans	66-7520	Chaincase sliding plate complete	1
41	B31 B32 B33 B34 and Gold Star Clubmans	66-7523	Chaincase sliding plate bolt	2

Plate 7

FRAME and FITTINGS

"B" Group (Rigid and Spring Frame)

Plate Ref. Number.	Models.	Part No.	Description.	Number per set.
1	B31 B32 B33 B34	29-7551	Footrest rubber	2
2	B31 B32 B33 B34	65-4891	Footrest bracket (offside)	1
3	B31 B32 B33 B34	24-5914	Footrest washer (plain)	2
4	B31 B32 B33 B34	65-695	Footrest washer (shakeproof)	2
5	B31 B32 B33 B34	15-5753	Footrest nut	2
6	B31 B32 B33 B34 Rigid	2-46	Engine plate and chainstay nuts	19

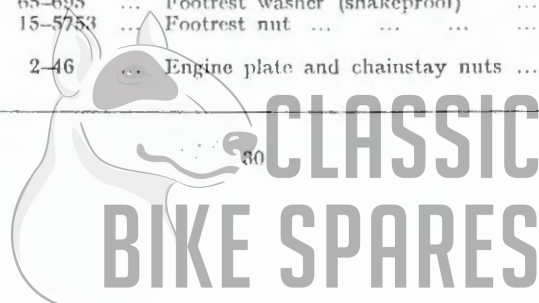
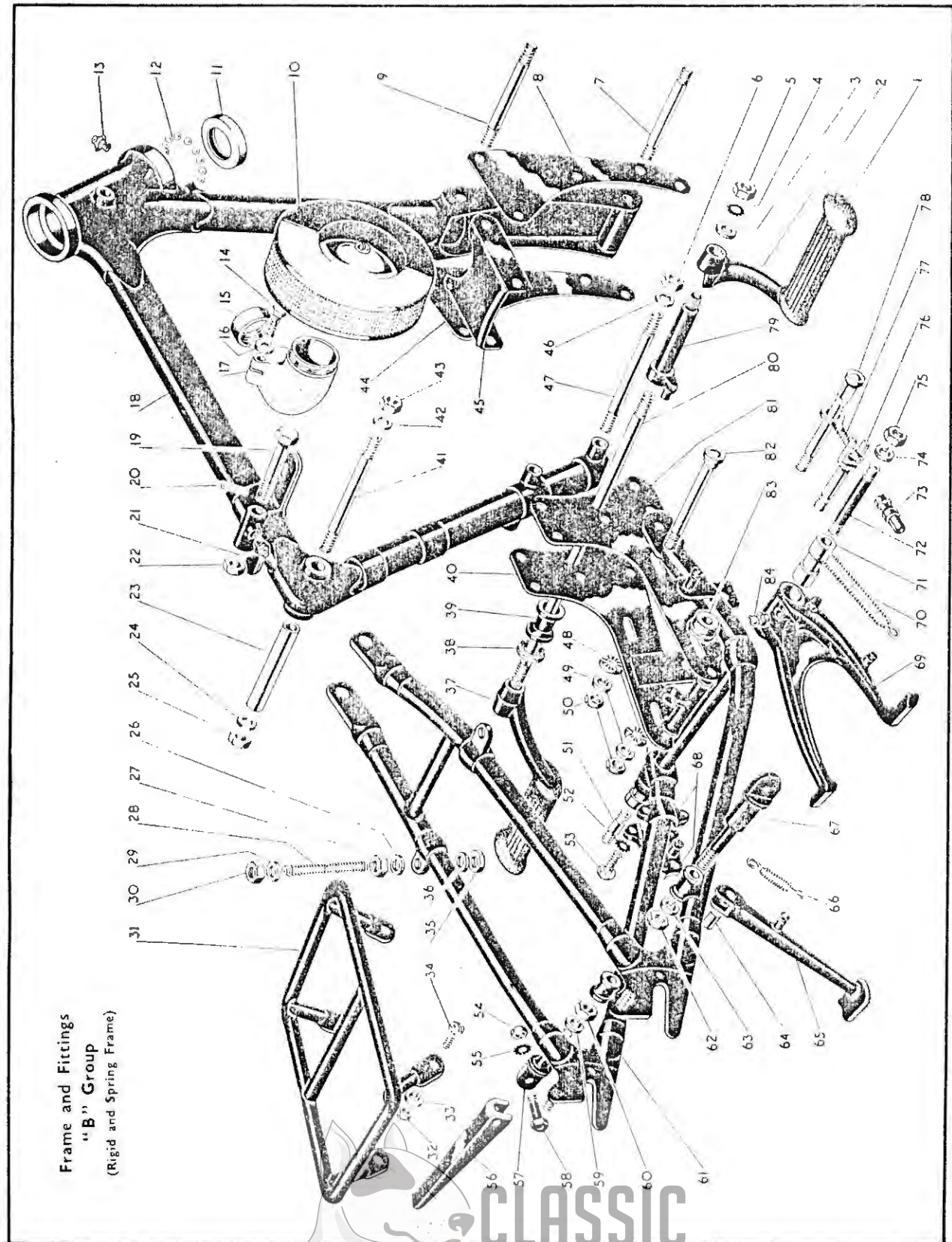

Plate 7.

FRAME and FITTINGS
"B" Group (Rigid and Spring Frame)



Frame and
Fittings
"B" Group

Frame and Fittings
"B" Group
(Rigid and Spring Frame)

CLASSIC
BIKE SPARES

FRAME and FITTINGS

“B” Group (Rigid and Spring Frame)

Plate Ref. Number.	Models.	Part No.	Description.	Number per set.
	B31 B32 B33 B34			
	Spring	2-46	Engine Plate and chainstay nuts	17
	B31 B33 Rigid	27-5684	Engine plate and front down tube stud	7
	B32 B34 Rigid	27-5684	Engine plate and front down tube stud	5
7	B31 B32 B33 B34			
	Spring	27-5684	Engine plate and front down tube stud	7
8	B31 B32 B33 B34	65-4429	Engine plate (front) (offside)	1
9	B31 B33	27-5683	Engine plate down tube and exhaust pipe stud	1
	B32 B34	27-5683	Engine plate and front down tube stud (when crankcase shield is fitted)	3
10	B31 B32 B33 B34	65-9196	Air cleaner	1
11	B31 B32 B33 B34	66-4149	Ball head cup	2
12	B31 B32 B33 B34	1/4" diam.	Ball head cup steel balls	40
13	B31 B32 B33 B34	28-2080	Grease nipple	1
14	B31 B32 B33 B34	2-14	Air cleaner elbow bolt	1
15	B33 B34	65-1237	Air cleaner adaptor	1
	B31 B32	65-1212	Air cleaner adaptor	1
16	B31 B32 B33 B34	29-541	Air cleaner elbow bolt washer	1
17	B31 B32 B33 B34	65-9198	Air cleaner elbow	1
18	B31 B32 B33 B34	65-4499	Frame front	1
19	B31 B32 B33 B34	33-4089	Saddle front connecting bolt	1
20	B31 B32 B33 B34			
	Rigid	35-698	Saddle front connecting bolt split pin	1
	B31 B32 B33 B34			
	Spring	15-1266	Saddle front connecting bolt split pin	1
21	B31 B32 B33 B34	28-2080	Saddle front connecting bolt grease nipple	1
22	B31 B32 B33 B34	66-2810	Saddle front connecting bolt nut	1
23	B31 B32 B33 B34	65-4488	Seat lug and backstay locating tube	1
24	B31 B32 B33 B34	15-431	Seat lug and backstay washer (nearside)	1
25	B31 B32 B33 B34	2-1925	Seat lug and backstay stud nut (nearside)	1
26	B31 B32 B33 B34			
	Rigid	2-923	Saddle rear fixing stud washer (centre)	2
	B31 B32 B33 B34			
	Spring	2-923	Saddle rear spring stud washer	4
27	B31 B32 B33 B34			
	Rigid	2-49	Saddle rear fixing stud nut (centre)	2
	B31 B32 B33 B34			
	Spring	2-49	Saddle rear fixing stud nut	4
28	B31 B32 B33 B34			
	Rigid	66-4647	Saddle rear fixing stud	2
	B31 B32 B33 B34			
	Spring	67-4040	Saddle rear fixing stud	2
29	B31 B32 B33 B34			
	Rigid	2-923	Saddle rear fixing stud washer (top)	2
30	B31 B32 B33 B34			
	Rigid	2-49	Saddle rear fixing stud nut (top)	2
31	B31 B32 B33 B34			
	Rigid	65-6897	Carrier	1
32	B31 B32 B33 B34	2-2395	Carrier fixing screw nut	4
33	B31 B32 B33 B34	2-1462	Carrier fixing screw washer	4
34	B31 B32 B33 B34	15-7161	Carrier fixing screw	4
35	B31 B32 B33 B34			
	Rigid	2-49	Saddle rear fixing stud nut (bottom)	2
36	B31 B32 B33 B34			
	Rigid	2-923	Saddle rear fixing stud washer (bottom)	2
37	B31 B32 B33 B34	65-4890	Footrest bracket (nearside)	1
38	B31 B32 B33 B34	66-4902	Footrest washer (cork)	2
39	B31 B32 B33 B34	66-4903	Chaincase distance sleeve	2
40	B31 B32 B33 B34	65-4519	Gearbox engine plate (nearside)	1
41	B31 B32 B33 B34	66-4175	Backstay and seat lug stud	1
42	B31 B32 B33 B34	15-431	Seat lug and backstay washer (offside)	1
43	B31 B32 B33 B34	2-1925	Seat lug and backstay stud nut (nearside)	1
44	B31 B32 B33 B34	65-4429	Engine plate front (nearside)	1
45	B31 B32 B33 B34	65-4431	Engine plate cover (front)	1
46	B31 B32 B33 B34	2-522	Engine plate, chainstay and seat tube washer	19
47	B31 B32 B33 B34	66-4163	Engine plate, chainstay and seat tube stud	1
48	B31 B32 B33 B34	65-4189	Gearbox connecting bolt washer (serrated)	2
49	B31 B32 B33 B34	2-522	Gearbox connecting bolt washer (spring)	2
50	B31 B32 B33 B34	2-46	Gearbox connecting bolt nut	2
51	B31 B32 B33 B34			
	Rigid	67-4032	Rear brake pedal and anchor strap stud	2

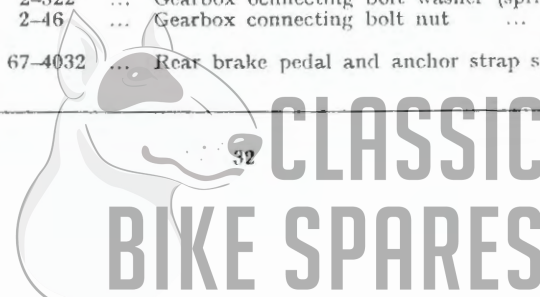

Plate 7—continued

FRAME and FITTINGS

“B” Group (Rigid and Spring Frame)

Plate Ref. Number.	Models.	Part No.	Description.	Number per set.
52	B31 B32 B33 B34 Spring	67-4032	Rear brake pedal anchor stud	1
53	B31 B32 B33 B34	36 382	Prop stand clip bolt washer	2
54	B31 B32 B33 B34	28 2338	Prop stand clip bolt	2
55	B31 B32 B33 B34	24-6040	Pillion footrest swivel bolt nut	2
56	B31 B32 B33 B34	36-382	Pillion footrest swivel bolt washer	2
57	B31 B32 B33 B34	29-7561	Pillion footrest only	2
58	B31 B32 B33 B34	65-4895	Pillion footrest anchor bolt (nearside)	1
59	B31 B32 B33 B34 Rigid	29-7564	Pillion footrest swivel bolt	2
60	B31 B32 B33 B34 Rigid	2-522	Pillion footrest anchor bolt washer (nearside)	1
61	B31 B32 B33 B34 Spring	2-1813	Pillion footrest anchor bolt nut (nearside)	1
62	B31 B32 B33 B34 Rigid	2-46	Pillion footrest anchor bolt nut (nearside)	1
63	B31 B32 B33 B34	65-4511	Chainstay and backstay complete	1
64	B31 B32 B33 B34	2-46	Pillion footrest anchor bolt nut (offside)	1
65	B31 B32 B33 B34	2-522	Pillion footrest anchor bolt washer (offside)	1
66	B31 B32 B33 B34	65-4741	Prop stand pivot pin	1
67	B31 B32 B33 B34 Rigid	65-4735	Prop stand leg	1
68	B31 B32 B33 B34 Spring	65-4742	Prop stand spring	1
69	B31 B32 B33 B34	65-4894	Pillion footrest anchor bolt (offside)	1
70	B31 B32 B33 B34	65-4895	Pillion footrest anchor bolt (nearside)	1
71	B31 B32 B33 B34	65-4739	Prop stand lug	1
72	B31 B32 B33 B34	65-4755	Central stand	1
73	B31 B32 B33 B34	65-4727	Central stand spring	1
74	B31 B32 B33 B34	29 4840	Central stand engine plate (distance piece)	1
75	B31 B32 B33 B34	65-4728	Central stand stud	1
76	B31 B32 B33 B34	15-5664	Gearbox adjusting bolt nut	1
77	B31 B32 B33 B34	2-1967	Central stand stud spring washer	2
78	B31 B32 B33 B34	2-1925	Central stand stud nut	2
79	B31 B32 B33 B34	65-4516	Rear engine plate and chainstay bridge bolt	1
80	B31 B32 B33 B34	27-5710	Gearbox adjusting bolt	1
81	B31 B32 B33 B34	66-4168	Gearbox connecting bolt (rear)	1
82	B31 B32 B33 B34	65-4811	Footrest rod distance tube	2
83	B31 B32 B33 B34	66-4900	Footrest rod	1
84	B31 B32 B33 B34	65-4517	Gearbox engine plate (offside)	1
85	B31 B32 B33 B34	15-476	Gearbox connecting bolt (front)	1
86	B31 B32 B33 B34	66-4169	Gearbox connecting bolt collar	1
87	B31 B32 B33 B34	35-5016	Central stand grease nipple	1

Rear Suspension

Plate 8

REAR SUSPENSION

“B” Group and Gold Star (Clubman’s) 350c.c. and 500c.c.

Plate Ref. Number.	Models.	Part No.	Description.	Number per set.
1	B31 B32 B33 B34 and Gold Star Clubmans	3-1399	Plunger carrier column bolt or suspension bottom bracket bolt (nearside)	1
2	B31 B32 B33 B34 and Gold Star Clubmans	2-46	Plunger carrier column bolt nut	4
3	B31 B32 B33 B34 and Gold Star Clubmans	66-4707	Plunger carrier column bolt washer (shakeproof)	4
4	B31 B32 B33 B34 and Gold Star Clubmans	67-4129	Plunger carrier bottom clip and silencer support bolt distance piece	2
5	B31 B32 B33 B34 and Gold Star Clubmans	67-4128	Plunger carrier bottom clip and silencer support bolt	1
6	B31 B32 B33 B34 and Gold Star Clubmans	36-382	Plunger carrier bottom clip and silencer support bolt washer (shakeproof)	1

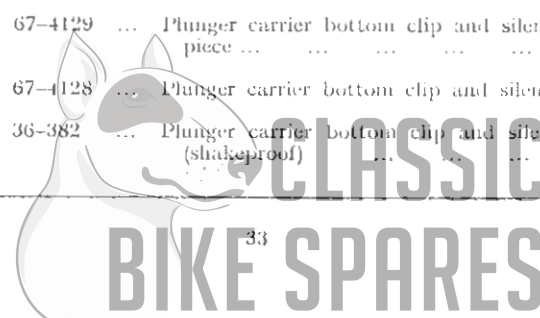

REAR SUSPENSION

"B" Group (Rigid and Spring Frame)

Plate Ref. Number.	Models.	Part No.	Description.	Number per set
7	B31 B32 B33 B34 and Gold Star Clubmans	2-49	Plunger carrier bottom clip and silencer support bolt nut	1
8	B31 B32 B33 B34 and Gold Star Clubmans	65-4741	Prop stand pivot pin	1
9	B31 B32 B33 B34 and Gold Star Clubmans	65-4735	Prop stand leg	1
10	B31 B32 B33 B34 and Gold Star Clubmans	65-4742	Prop stand spring	1
11	B31 B32 B33 B34 and Gold Star Clubmans	65-4743	Prop stand lug complete	1
12	B31 B32 B33 B34 and Gold Star Clubmans	36-382	Prop stand clip bolt washer (shakeproof)	2
13	B31 B32 B33 B34 and Gold Star Clubmans	28-2338	Prop stand clip bolt	2
14	B31 B32 B33 B34 and Gold Star Clubmans	65-7060	Rear brake pedal	1
15	B31 B32 B33 B34 and Gold Star Clubmans	65-7063	Rear brake pedal return spring	1
16	B31 B32 B33 B34 and Gold Star Clubmans	30-196	Rear brake pedal washer (plain)	1
17	B31 B32 B33 B34 and Gold Star Clubmans	2-522	Rear brake pedal washer (spring)	1
18	B31 B32 B33 B34 and Gold Star Clubmans	67-4032	Rear brake pedal stud	1
19	B31 B32 B33 B34 and Gold Star Clubmans	67-4040	Saddle rear fixing stud	2
20	B31 B32 B33 B34 and Gold Star Clubmans	2-923	Saddle rear fixing stud washer	2
21	B31 B32 B33 B34 and Gold Star Clubmans	2-49	Saddle rear fixing stud nut	2
22	B31 B32 B33 B34 and Gold Star Clubmans	2-923	Saddle rear fixing stud washer	2
23	B31 B32 B33 B34 and Gold Star Clubmans	2-49	Saddle rear fixing stud nut	2
24	B31 B32 B33 B34 and Gold Star Clubmans	67-6921	Carrier complete	1
25	B31 B32 B33 B34 and Gold Star Clubmans	2-2395	Carrier fixing screw nut	4
26	B31 B32 B33 B34 and Gold Star Clubmans	2-1462	Carrier fixing screw washer (spring)	4
27	B31 B32 B33 B34 and Gold Star Clubmans	15-7161	Carrier fixing screw	4
28	B31 B32 B33 B34 and Gold Star Clubmans	67-6761	Horn and saddle spring distance piece	1
29	B31 B32 B33 B34 and Gold Star Clubmans	31-68	Plunger carrier column bolt (top)	2
30	B31 B32 B33 B34 and Gold Star Clubmans	65-4185	Plunger carrier column bolt (top)	2
31	B31 B32 B33 B34 and Gold Star Clubmans	67-4130	Lifting handle	1
32	B31 B32 B33 B34 and Gold Star Clubmans	66-4707	Plunger carrier column bolt (top) washer (shakeproof)	4
33	B31 B32 B33 B34 and Gold Star Clubmans	2-46	Plunger carrier column bolt (top) nut	4
34	B31 B32 B33 B34 and Gold Star Clubmans	65-4526	Chainstay and backstay complete	1
35	B31 B32 B33 B34 and Gold Star Clubmans	2-46	Rear brake pedal stud nut	1
36	B31 B32 B33 B34 and Gold Star Clubmans	89-4258	Rebound spring bottom collar	2
37	B31 B32 B33 B34 and Gold Star Clubmans	89-4259	Rebound spring bottom	2
38	B31 B32 B33 B34 and Gold Star Clubmans	65-4147	Rebound spring bottom	2
39	B31 B32 B33 B34 and Gold Star Clubmans	67-4125	Rear spindle clamp lug (nearside)	1
40	B31 B32 B33 B34 and Gold Star Clubmans	67-4126	Rear spindle clamp lug (offside)	1
41	B31 B32 B33 B34 and Gold Star Clubmans	2-46	Clamp lug bolt nut	2
42	B31 B32 B33 B34 and Gold Star Clubmans	66-4707	Clamp lug bolt washer (shakeproof)	2
43	B31 B32 B33 B34 and Gold Star Clubmans	67-4127	Rebound spring top collar	2
44	B31 B32 B33 B34 and Gold Star Clubmans	67-4131	Plunger spring washer (bottom)	2
45	B31 B32 B33 B34 and Gold Star Clubmans	89-4049	Plunger spring top	2
46	B31 B32 B33 B34 and Gold Star Clubmans	89-4257	Plunger spring top collar	2
47	B31 B32 B33 B34 and Gold Star Clubmans	89-4249	Plunger spring inner shroud	2



REAR SUSPENSION

"B" Group and Gold Star (Clubman's) 350c.c. and 500c.c.

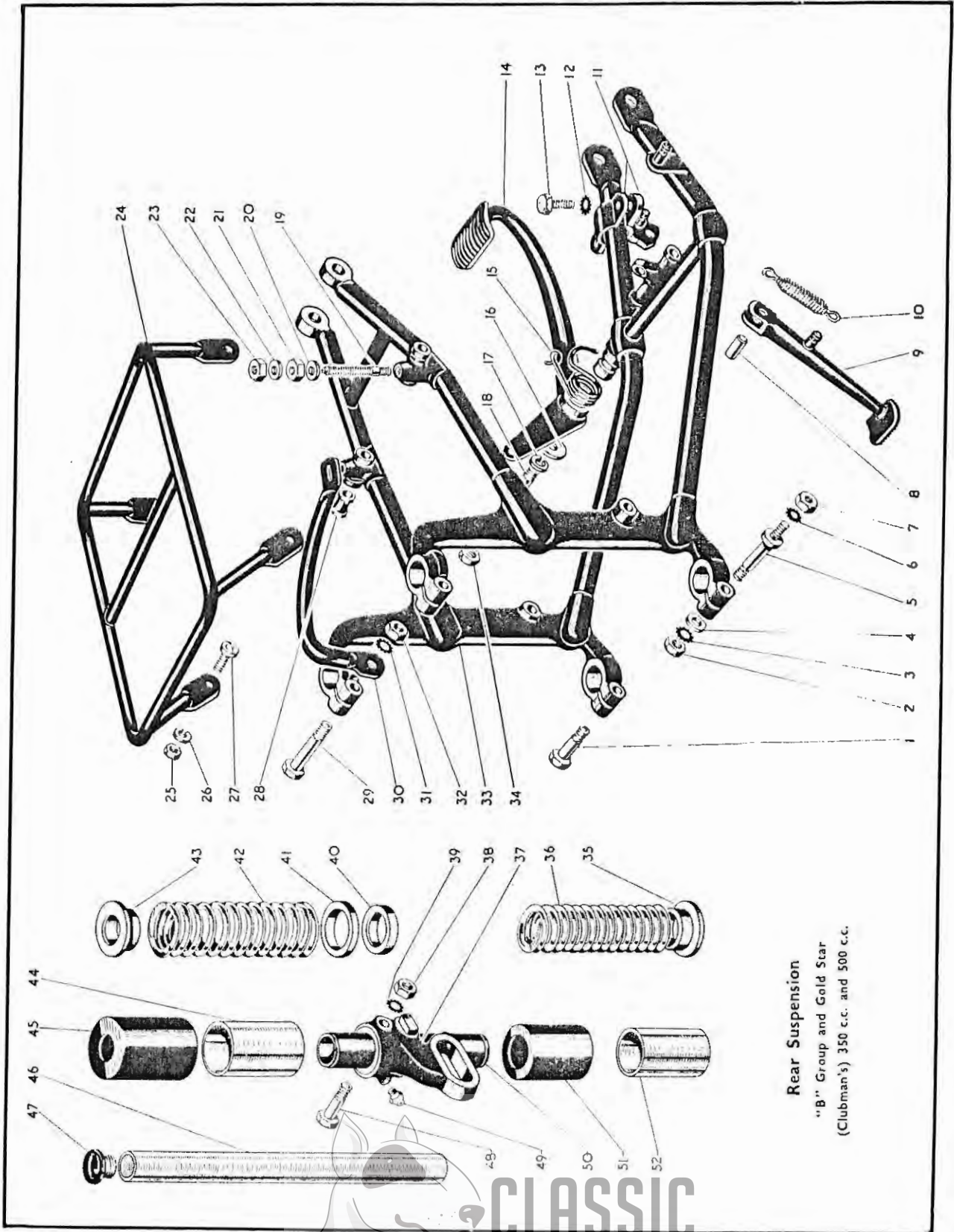

Rear Suspension
"B" Group and Gold Star
(Clubman's) 350 c.c. and 500 c.c.

Plate 8—continued

REAR SUSPENSION

“B” Group (Rigid and Spring Frame)

Plate Ref. Number.	Models.	Part No.	Description.	Number per set.
45	B31 B32 B33 B34 and Gold Star Clubmans	89-4248	Plunger spring outer shroud	2
46	B31 B32 B33 B34 and Gold Star Clubmans	89-4041	Plunger carrier column assembly	2
47	B31 B32 B33 B34 and Gold Star Clubmans	89-4045	Plunger column screwed plug	2
48	B31 B32 B33 B34 and Gold Star Clubmans	3-1399	Clamp lug bolt	2
49	B31 B32 B33 B34 and Gold Star Clubmans	28-2080	Clamp lug grease nipple	2
50	B31 B32 B33 B34 and Gold Star Clubmans	89-4046	Plunger tube with bushes	2
51	B31 B32 B33 B34 and Gold Star Clubmans	89-4240	Rebound spring shroud (outer)	2
52	B31 B32 B33 B34 and Gold Star Clubmans	89-4241	Rebound spring shroud (inner)	2

Plate 9 FRAME and FITTINGS (Footrests in rear position)

Gold Star (Clubman's) 350c.c. and 500c.c.

Plate Ref. Number.	Models.	Part No.	Description.	Number per set.
1	Gold Star Clubmans B32 B34 and	65-4547	Chainstay and backstay complete	1
2	Gold Star Clubmans	65-2850	Crankcase shield	1
3	Gold Star Clubmans	65-4912	Footrest bracket sleeve	2
4	Gold Star Clubmans	2-46	Folding footrest anchor bolt nut	1
5	Gold Star Clubmans	2-522	Folding footrest anchor bolt washer (spring)	1
6	Gold Star Clubmans	65-4916	Folding footrest bracket	1
7	Gold Star Clubmans	24-5914	Footrest bracket bolt washer	2
8	Gold Star Clubmans	3-1383	Footrest bracket bolt (offside)	1
9	Gold Star Clubmans	29-7564	Folding footrest swivel bolt	1
10	Gold Star Clubmans	65-4917	Folding footrest anchor bolt	1
11	Gold Star Clubmans	36-382	Folding footrest swivel bolt washer (shakeproof)	1
12	Gold Star Clubmans	29-7561	Folding footrest with stiffening piece	1
13	Gold Star Clubmans	29-7551	Footrest rubber	2
14	Gold Star Clubmans	24-6040	Folding footrest swivel bolt nut	1
15	Gold Star Clubmans	29-5315	Gearbox connecting bolt (front) nut	1
16	Gold Star Clubmans	2-522	Gearbox connecting bolt (front) washer (spring)	2
17	Gold Star Clubmans	65-4189	Gearbox connecting bolt (front) serrated washer	1
18	Gold Star Clubmans	15-5753	Chaincase and rear engine plate stud nut	2
19	Gold Star Clubmans	65-695	Chaincase and rear engine plate stud washer (shakeproof)	2
20	Gold Star Clubmans	66-4604	Chaincase and rear engine plate stud	1
21	Gold Star Clubmans	65-4517	Gearbox engine plate (offside)	1
21A	Gold Star Clubmans	65-4519	Gearbox engine plate (nearside)	1
22	Gold Star Clubmans	65-4541	Gearbox connecting bolt (front) serrated washer	1
23	Gold Star Clubmans	65-4540	Gearbox connecting bolt (front)	1
24	Gold Star Clubmans	24-5914	Engine plate washer	1
25	Gold Star Clubmans	65-7592	Chaincase and engine plate distance collar	1
26	Gold Star Clubmans	65-7593	Chaincase distance collar	1
27	Gold Star Clubmans	66-4903	Chaincase distance piece	1
28	Gold Star Clubmans	2-108	Footrest washer (steel)	1
29	Gold Star Clubmans	66-4902	Footrest washer (cork)	1
30	Gold Star Clubmans	65-4488	Locating tube (seat lug and backstay)	1
31	Gold Star Clubmans	67-9095	Backstay and seat lug stud (when dual seat fitted)	1
32	Gold Star Clubmans	15-431	Backstay and seat lug stud washer (plain)	2
33	Gold Star Clubmans	2-1925	Backstay and seat lug stud nut	2
34	Gold Star Clubmans	67-6761	Horn and saddle spring distance piece	1
35	Gold Star Clubmans	15-518	Rear brake pedal pinch bolt	1
36	Gold Star Clubmans	36-382	Rear brake pedal pinch bolt washer (shakeproof)	1
37	Gold Star Clubmans	65-4923	Footrest and rear brake pedal stop bolt (nearside)	1
38	Gold Star Clubmans	65-4911	Footrest bracket (nearside)	1
39	Gold Star Clubmans	65-7081	Rear brake pedal complete	1
40	Gold Star Clubmans	65-7078	Rear brake pedal return spring	1
41	Gold Star Clubmans	67-7027	Rear brake operating lever	1
42	Gold Star Clubmans	27-8119	Footrest bracket bolt nut	2
43	Gold Star Clubmans	65-695	Footrest bracket bolt washer (shakeproof)	2
44	Gold Star Clubmans	24-5914	Footrest bracket bolt washer	2



Plate 9.

FRAME and FITTINGS (Footrests in rear position)

Gold Star (Clubman's) 350c.c. and 500c.c.

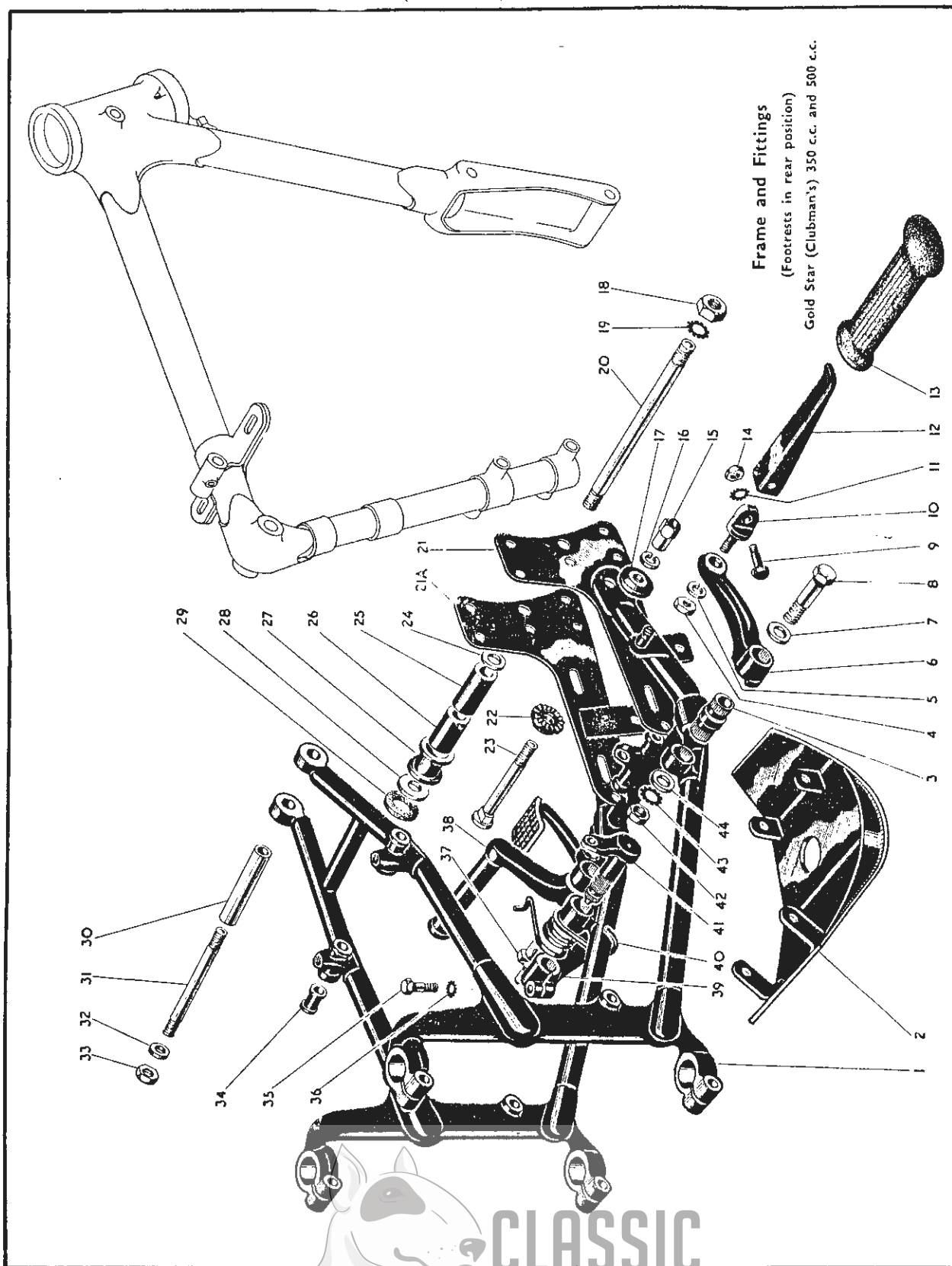

Frame and Fittings
(Footrests in rear position)
Gold Star (Clubman's) 350 c.c. and 500 c.c.

Frame and Fittings
Gold Star



Plate 10

FRONT FORK and FITTINGS

"B" Group and Gold Star (Clubman's) 350c.c. and 500c.c.

Plate Ref. Number.	Models.	Part No.	Description.	Number per set.
...	B31 B33	65-5400	Front fork assembled	1
...	B32 B34	65-5401	Front fork assembled	1
...	Gold Star Clubmans	65-5402	Front fork assembled	1
1	B31 B32 B33 B34 and	2-1309	Fork end drain plug	2
2	Gold Star Clubmans	2 292	Fork end drain plug washer (fibre)	2
...	B31 B32 B33 B34	65-5408	Front fork sliding tube (nearside)	1
3	Gold Star Clubmans	67-5057	Front fork sliding tube (nearside)	1
4	B31 B32 B33 B34 and	29-5334	Top bush shim (.005")	1
...	Gold Star Clubmans	29-5335	Top bush shim (.010")	1
...	B31 B32 B33 B34 and	29-5336	Top bush shim (.020")	1
...	Gold Star Clubmans	29-5337	Top bush shim (.030")	1
5	B32 B34 and	65-5424	Front fork top bearing	2
6	Gold Star Clubmans	29-5346	Front fork top bearing	2
7	B31 B32 B33 B34 and	29-5320	Front fork top bearing circlip	2
8	Gold Star Clubmans	29-5313	Front fork oil seal	2
9	B31 B32 B33 B34 and	29-5310/3	Front fork oil seal holder complete	2
10	Gold Star Clubmans	65-5390	Front fork spring	2
11	B31 B32 B33 B34 and	67-5042	Front fork outer sleeve (nearside)	1
12	Gold Star Clubmans	27-5135	Top yoke clip bolt	1
13	B31 B32 B33 B34 and	65-5333	Handlebar clip	1
14	Gold Star Clubmans	65-5421	Steering damper knob securing plate	1
15	B31 B32 B33 B34	15-5155	Handlebar clip bolt washer (plain)	4
...	Gold Star Clubmans	2-923	Handlebar clip bolt washer (plain)	2
...	Gold Star Clubmans	15-5155	Handlebar clip bolt washer (plain)	2
16	Gold Star Clubmans	2-6026	Handlebar clip and damper knob securing plate bolt	2
...	B31 B32 B33 B34 and	65-5334	Handlebar clip bolt	4
17	Gold Star Clubmans	67-5024	Steering damper adjusting sleeve cap	1
18	B31 B32 B33 B34 and	65-5295	Fork end bolt (nearside)	1
19	Gold Star Clubmans	2-2903	Fork end bolt washer (spring)	1
20	B31 B32 B33 B34 and	29-5283	Front fork shaft plug	2
21	Gold Star Clubmans	29-5347	Front fork bottom bearing	2
22	B31 B33	67-5014	Front fork shaft	1
...	B32 B34 and	89-5061	Front fork shaft	1
23	Gold Star Clubmans	66-5089	Front fork bottom yoke	1
24	B31 B32 B33 B34 and	65-5127	Steering head ballrace cone (bottom)	1
25	Gold Star Clubmans	66-4149	Ball head cup	2
26	B31 B32 B33 B34 and	65-5126	Steering head ballrace cone (top)	1
27	Gold Star Clubmans	66-5203	Steering head dust cap	1
28	B31 B32 B33 B34 and	29-5315	Top yoke clip bolt nut	1
29	Gold Star Clubmans	67-5023	Steering damper adjusting sleeve	1
...	B31 B32 B33 B34	65-5410	Front fork sliding tube (offside)	1
30	Gold Star Clubmans	65-5420	Front fork sliding tube (offside)	1
31	B31 B32 B33 B34 and	29-5310/3	Front fork oil seal holder complete	2

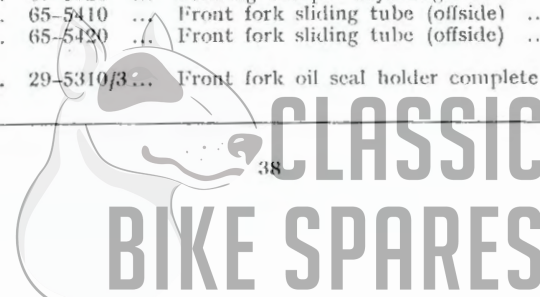
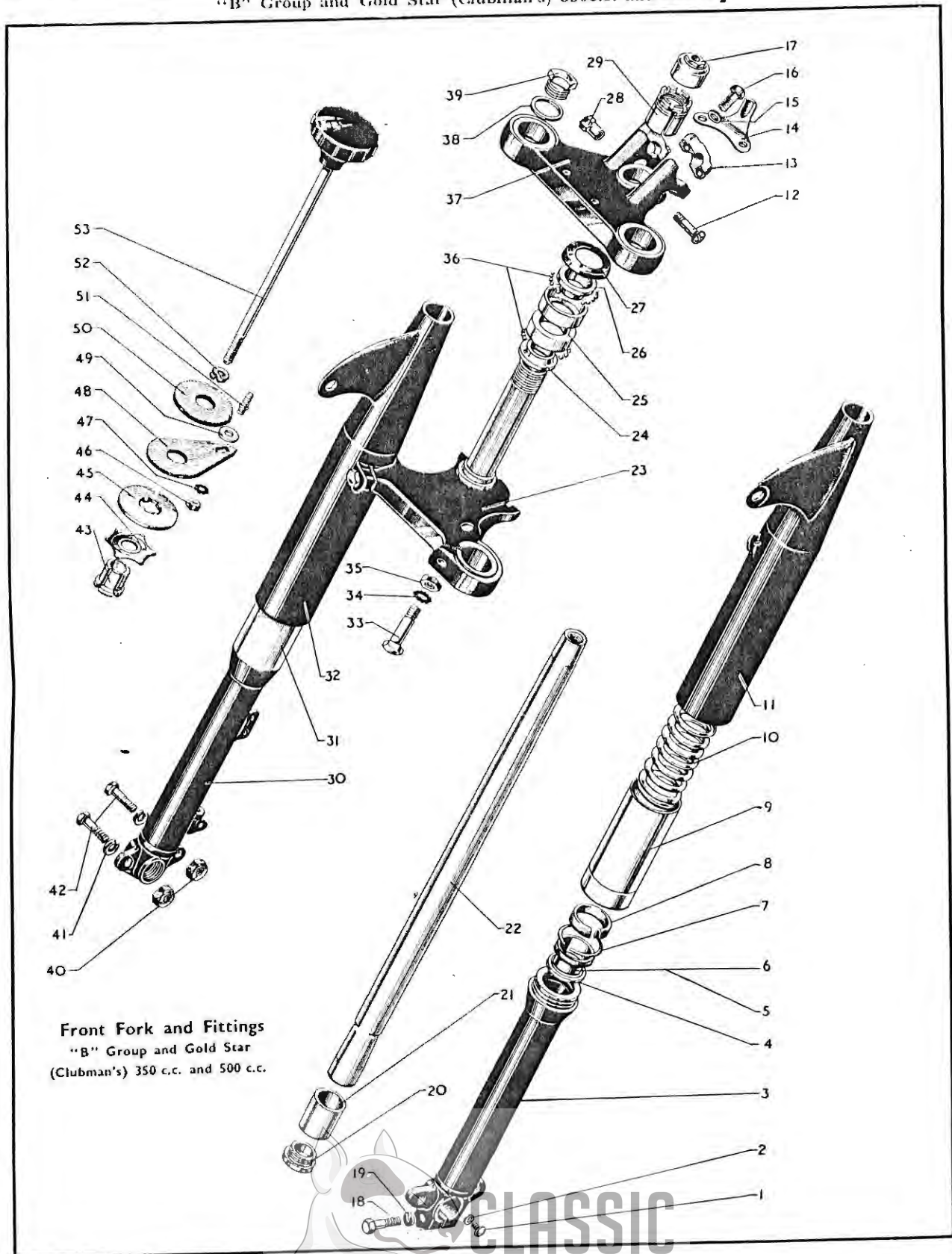

Plate 10.

FRONT FORK and FITTINGS

"B" Group and Gold Star (Clubman's) 350c.c. and 500c.c.†



Front For
and
Fittings

Front Fork and Fittings
"B" Group and Gold Star
(Clubman's) 350 c.c. and 500 c.c.

Plate 10—continued

FRONT FORK and FITTINGS

"B" Group and Gold Star (Clubman's) 350c.c. and 500c.c.

Plate Ref. Number.	Models.	Part No.	Description.	Number per set.
32	B31 B32 B33 B34 and Gold Star Clubmans	67-5044	Fork outer sleeve (offside)	1
33	B31 B32 B33 B34 and Gold Star Clubmans	29-5289	Bottom yoke bolt	2
34	B31 B32 B33 B34 and Gold Star Clubmans	36-382	Bottom yoke bolt washer (shakeproof)	2
35	B31 B32 B33 B34 and Gold Star Clubmans	24-5160	Bottom yoke bolt nut	2
36	B31 B32 B33 B34 and Gold Star Clubmans	1"	Steering head balls	40
37	B31 B32 B33 B34 and Gold Star Clubmans	66-5088	Front fork top yoke	1
38	B31 B32 B33 B34 and Gold Star Clubmans	65-5332	Fork tube nut washer (plain)	1
39	B31 B32 B33 B34 and Gold Star Clubmans	65-5331	Fork tube nut	1
40	B31 B32 B33 B34 and Gold Star Clubmans	2-1616	Fork end mudguard stay bolt nut	4
41	B31 B32 B33 B34 and Gold Star Clubmans	24-8784	Fork end mudguard stay bolt washer	4
42	B31 B32 B33 B34 and Gold Star Clubmans	15-7354	Fork end mudguard stay bolt	4
43	B31 B32 B33 B34 and Gold Star Clubmans	65-5328	Steering damper centre	1
44	B31 B32 B33 B34 and Gold Star Clubmans	25-5247	Steering damper star washer	1
45	B31 B32 B33 B34 and Gold Star Clubmans	25-5241	Steering damper bottom plate	1
46	B31 B32 B33 B34 and Gold Star Clubmans	2-49	Steering damper anchor plate stud nut	1
47	B31 B32 B33 B34 and Gold Star Clubmans	36-382	Steering damper anchor plate stud washer (shakeproof)	1
48	B31 B32 B33 B34 and Gold Star Clubmans	27-5152	Steering damper anchor plate	1
49	B31 B32 B33 B34 and Gold Star Clubmans	2-923	Steering damper anchor plate stud washer (plain)	1
50	B31 B32 B33 B34 and Gold Star Clubmans	65-5380	Steering damper friction washer	2
51	B31 B32 B33 B34 and Gold Star Clubmans	65-5327	Steering damper anchor plate stud	1
52	B31 B32 B33 B34 and Gold Star Clubmans	24-6035	Steering damper rod washer (spring)	1
53	B31 B32 B33 B34 and Gold Star Clubmans	67-5021	Steering damper adjusting rod	1

Plate 11

FRONT HUB and WHEEL FITTINGS

Gold Star (Clubman's) 350c.c. and 500c.c.

Plate Ref. Number.	Models.	Part No.	Description.	Number per set.
—	Gold Star Clubmans	65-5925	Front wheel complete (less brake and tyre)	1
1	Gold Star Clubmans	24-7014	Front wheel spoke (short)	20
2	Gold Star Clubmans	27-6810	Front wheel spoke nipple	40
3	Gold Star Clubmans	67-5566	Front hub spindle	1
4	Gold Star Clubmans	67-5561	Front hub bearing locking ring (nearside)	1
5	Gold Star Clubmans	35-701	Front hub bearing locking ring retaining pin	1
6	Gold Star Clubmans	67-5563	Front hub bearing oil retaining washer (nearside)	1
7	Gold Star Clubmans	65-5883	Front hub ball journal	1
8	Gold Star Clubmans	15-5290	Front hub grease nipple	1
9	Gold Star Clubmans	67-5547	Front hub shell complete (with spindle and bearings)	1
10	Gold Star Clubmans	65-5936	Front wheel rim (light alloy)	1
		65-5927	Front Wheel rim	1
11	Gold Star Clubmans	65-5926	Front wheel spoke (long)	20
12	Gold Star Clubmans	67-5565	Front hub spindle sleeve	1
13	Gold Star Clubmans	65-5883	Front hub ball journal	1
14	Gold Star Clubmans	67-5564	Front hub bearing oil retaining washer (offside)	1



FRONT HUB AND WHEEL FITTINGS

"B" Group and Gold Star (Clubman's) 350c.c. and 500c.c.

Front Hub and Wheel Fittings
Gold Star (Clubman's) 350 c.c. and 500 c.c.

Front Hub and Wheel Fittings
"B" Group

Front Hub
and Wheel
Fittings

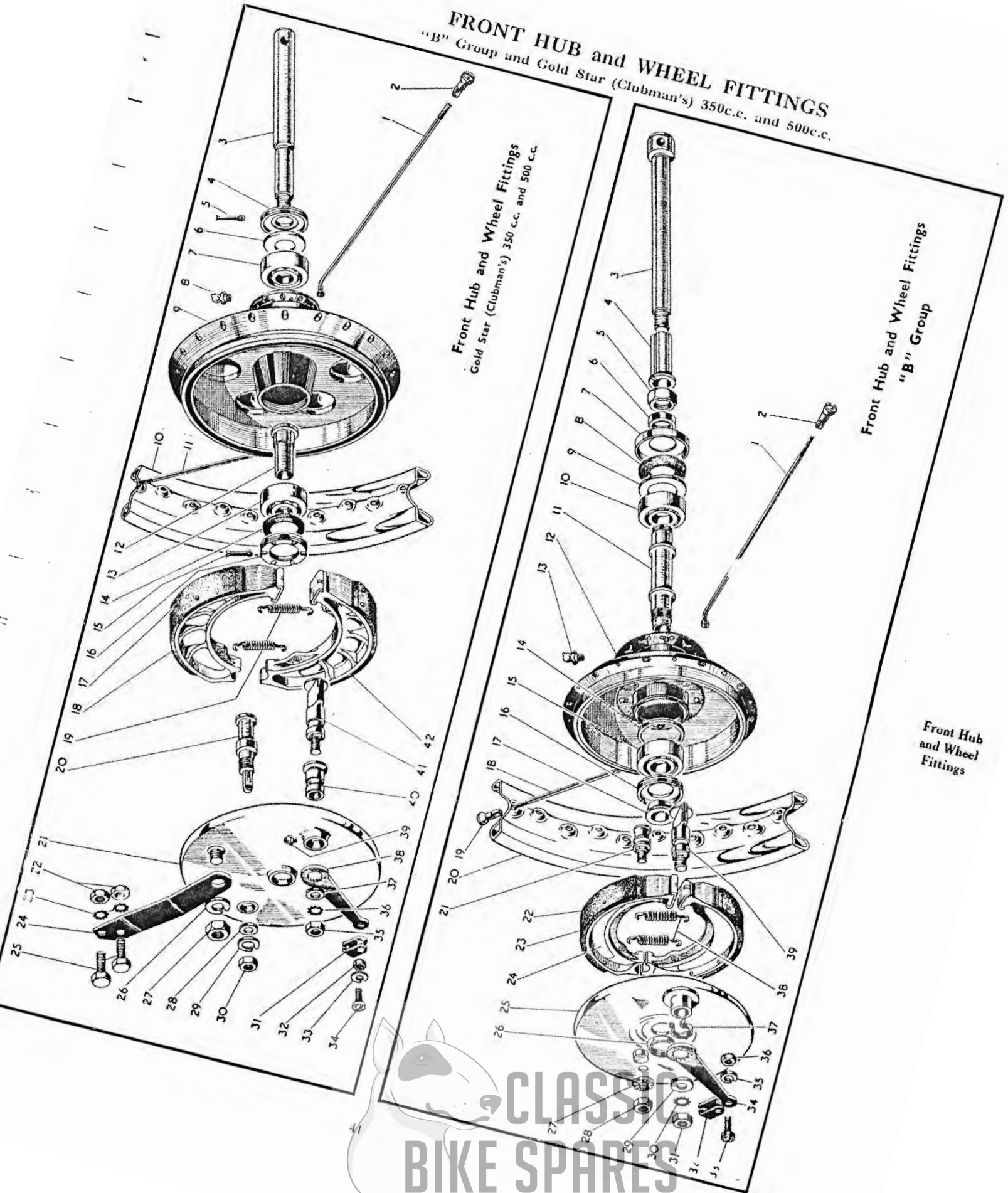

Plate 11—continued

FRONT HUB and WHEEL FITTINGS

Gold Star (Clubman's) 350c.c. and 500c.c.

Plate Ref. Number.	Models.	Part No.	Description.	Number per set.
15	Gold Star Clubmans	35-701	Front hub bearing locking ring retaining pin	1
16	Gold Star Clubmans	67-5562	Front hub bearing locking ring (offside)	1
17	Gold Star Clubmans	67-5575	Front brake shoe lining rivet	14
18	Gold Star Clubmans	67-5571	Front brake shoe lining	2
19	Gold Star Clubmans	65-5904	Front brake shoe spring	2
20	Gold Star Clubmans	67-5576	Front brake fulcrum and adjusting pin	1
21	Gold Star Clubmans	67-5555/21	Front brake cover plate with fixed fittings	1
22	Gold Star Clubmans	2-49	Front brake anchor strap nut	2
23	Gold Star Clubmans	36-382	Front brake anchor strap nut washer	2
24	Gold Star Clubmans	67-5578	Front brake anchor strap	1
25	Gold Star Clubmans	32-194	Front brake anchor strap bolt	2
26	Gold Star Clubmans	15-716	Front brake cover plate and anchor strap spring washer	1
27	Gold Star Clubmans	15-541	Front brake cover plate and anchor strap nut	1
28	Gold Star Clubmans	25-6014	Front brake fulcrum and adjusting pin washer (plain)	1
29	Gold Star Clubmans	35-37	Front brake fulcrum and adjusting pin spring washer	1
30	Gold Star Clubmans	2-2527	Front brake fulcrum and adjusting pin nut	1
31	Gold Star Clubmans	29-5871	Front brake lever toggle	1
32	Gold Star Clubmans	2-443	Front brake lever toggle nut	1
33	Gold Star Clubmans	2-1462	Front brake lever toggle washer	1
34	Gold Star Clubmans	2-510	Front brake lever toggle screw	1
35	Gold Star Clubmans	2-440	Front brake shoe cam nut	1
36	Gold Star Clubmans	66-4708	Front brake shoe cam washer (shakeproof)	1
37	Gold Star Clubmans	15-431	Front brake shoe cam washer (plain)	1
38	Gold Star Clubmans	65-5907	Front brake operating lever	1
39	Gold Star Clubmans	28-2080	Front brake fulcrum pin grease nipple	1
40	Gold Star Clubmans	67-5567	Front brake cam bearing	1
41	Gold Star Clubmans	67-5572	Front brake shoe cam complete	1
42	Gold Star Clubmans	67-5558	Front brake shoe with lining	1

Plate 11—continued

FRONT HUB and WHEEL FITTINGS

"B" Group

Plate Ref. Number.	Models.	Part No.	Description.	Number per set.
—	B31 B33	65-5870	Front wheel complete (less brake and tyre)	1
—	B32 B34	65-5915	Front wheel complete (less brake and tyre)	1
1	B31 B33	65-5872	Front wheel spoke (long)	20
—	B32 B34	65-5537	Front wheel spoke (long)	20
2	B31 B32 B33 B34	27-6810	Front wheel spoke nipple	20
3	B31 B32 B33 B34	65-5929	Front hub spindle	1
4	B31 B32 B33 B34	65-5892	Front hub spindle distance piece	1
5	B31 B32 B33 B34	65-5893	Front brake cover plate nut	1
6	B31 B32 B33 B34	65-5890	Front hub distance collar	1
7	B31 B32 B33 B34	65-5888	Front hub felt washer retaining cup	1
8	B31 B32 B33 B34	65-5886	Front hub washer (felt)	1
9	B31 B32 B33 B34	65-5887	Front hub felt washer retaining ring	1
10	B31 B32 B33 B34	65-5883	Front hub ball journal	1
11	B31 B32 B33 B34	65-5889	Front hub spindle sleeve	1
12	B31 B32 B33 B34	65-5876	Front hub shell complete (with bearings)	1
13	B31 B32 B33 B34	15-5290	Front hub grease nipple	1
14	B31 B32 B33 B34	65-5884	Front hub bearing thrust washer	1
15	B31 B32 B33 B34	65-5883	Front hub ball journal	1
16	B31 B32 B33 B34	65-5885	Front hub bearing retaining ring	1
17	B31 B32 B33 B34	65-5891	Front hub distance piece	1
18	B31 B33	65-5910	Front wheel spoke (short)	20
—	B32 B34	15-622	Front wheel spoke (short)	20
19	B31 B32 B33 B34	27-6810	Front wheel spoke nipple	20
20	B31 B33	67-5543	Front wheel rim	1
—	B32 B34	65-5916	Front wheel rim	1
21	B31 B32 B33 B34	65-5899	Front brake shoe fulcrum pin	1
22	B31 B32 B33 B34	36-6436	Front brake shoe lining rivet	14
23	B31 B32 B33 B34	65-5903	Front brake shoe lining	2
24	B31 B32 B33 B34	65-5901	Front brake shoe with lining	2
25	B31 B32 B33 B34	65-5895/7	Front brake cover plate complete	1
26	B31 B32 B33 B34	65-5893	Front brake cover plate nut	1
27	B31 B32 B33 B34	24-8045	Front brake fulcrum pin serrated washer	1
28	B31 B32 B33 B34	24-5860	Front brake fulcrum pin nut	1
29	B31 B32 B33 B34	15-431	Front brake shoe cam washer (plain)	1

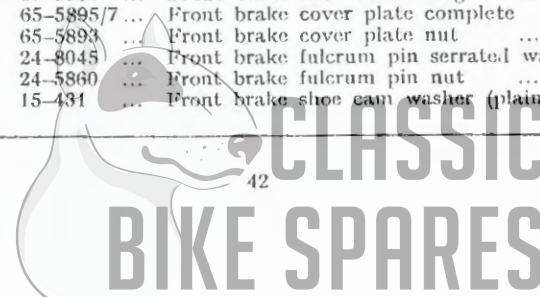

Plate 11—continued

FRONT HUB and WHEEL FITTINGS

"B" Group

Plate Ref. Number.	Models.	Part No.	Description.	Number per set.
30	B31 B32 B33 B34	66-4708	Front brake shoe cam washer (shakeproof)	1
31	B31 B32 B33 B34	2-440	Front brake shoe cam nut	1
32	B31 B32 B33 B34	29-5871	Front brake lever toggle	1
33	B31 B32 B33 B34	2-510	Front brake lever toggle screw	1
34	B31 B32 B33 B34	65-5907	Front brake operating lever	1
35	B31 B32 B33 B34	2-1462	Front brake lever toggle washer (spring)	1
36	B31 B32 B33 B34	2-443	Front brake lever toggle nut	1
37	B31 B32 B33 B34	65-5674	Front brake shoe cam bearing oil hole clip	1
38	B31 B32 B33 B34	65-5904	Front brake shoe spring	2
39	B31 B32 B33 B34	65-5905	Front brake shoe cam complete	1

Plate 12

REAR HUB and WHEEL FITTINGS

"B" Group (Spring Frame) and Gold Star (Clubman's) 350c.c. and 500c.c.

Plate Ref. Number.	Models.	Part No.	Description.	Number per set.
...	Gold Star Clubmans	65-6305	Rear wheel complete (less brake and tyre)	1
...	B31 B33 Rigid	65-6285	Rear wheel complete (less brake and tyre)	1
...	B32 B34 Rigid	65-6286	Rear wheel complete (less brake and tyre)	1
...	B31 B33 Spring	65-6300	Rear wheel complete (less brake and tyre)	1
...	B32 B34 Spring	65-6297	Rear wheel complete (less brake and tyre)	1
...	B31 B32 B33 B34			
1	Spring Frame	65-7071	Rear brake rod with toggle end	1
...	Gold Star Clubmans	65-7075	Rear brake rod with toggle end	1
...	B31 B32 B33 B34			
2	Spring Frame and			
...	Gold Star Clubmans	24-8045	Rear brake shoe fulcrum pin washer	1
...	B31 B32 B33 B34			
3	Spring Frame and			
...	Gold Star Clubmans	24-5860	Rear brake shoe fulcrum pin locknut	1
...	B31 B32 B33 B34			
4	Spring Frame and			
...	Gold Star Clubmans	2-2395	Rear brake rod spring nut	1
...	B31 B32 B33 B34			
5	Spring Frame and			
...	Gold Star Clubmans	67-6074	Rear hub bearing sleeve nut	1
...	B31 B32 B33 B34			
6	Spring Frame and			
...	Gold Star Clubmans	15-1312	Rear brake rod spring	1
...	B31 B32 B33 B34			
7	Spring Frame and			
...	Gold Star Clubmans	67-6073	Rear hub spindle nut complete	1
...	B31 B32 B33 B34			
8	Spring Frame and			
...	Gold Star Clubmans	65-6279	Rear brake operating lever	1
...	B31 B32 B33 B34			
9	Spring Frame and			
...	Gold Star Clubmans	65-6274	Rear brake screw swivel pin	1
...	B31 B32 B33 B34			
10	Spring Frame and			
...	Gold Star Clubmans	67-7031	Adjusting nut extension tube	1
...	B31 B32 B33 B34			
11	Spring Frame and			
...	Gold Star Clubmans	29-7368	Rear brake adjuster ferrule	1
...	B31 B32 B33 B34			
12	Spring Frame and			
...	Gold Star Clubmans	2-440	Rear brake operating lever nut	1
...	B31 B32 B33 B34			
13	Spring Frame and			
...	Gold Star Clubmans	66-4708	Rear brake operating lever washer (shakeproof)	1
...	B31 B32 B33 B34			
14	Spring Frame and			
...	Gold Star Clubmans	15-431	Rear brake operating lever washer (plain)	1
...	B31 B32 B33 B34			
15	Spring Frame and			
...	Gold Star Clubmans	67-6081	Rear brake anchor strap	1
...	B31 B32 B33 B34			
16	Spring Frame and			
...	Gold Star Clubmans	65-5674	Rear brake cam bearing oil clip	1

Rear Hu
and Whe
Fitting:



Plate 12—continued REAR HUB and WHEEL FITTINGS

"B" Group (Spring Frame) and Gold Star (Clubman's) 350c.c. and 500c.c.

Plate Ref. Number	Models.	Part No.	Description.	Number per set.
17	B31 B32 B33 B34 Spring Frame	67-6180	Rear wheel cover plate complete	1
	Gold Star Clubmans	67-6180	Rear wheel cover plate complete	1
18	B31 B32 B33 B34 Spring Frame and Gold Star Clubmans	65-5905	Rear brake shoe cam complete	1
19	B31 B32 B33 B34 Spring Frame and Gold Star Clubmans	65-5901	Rear brake shoe complete	2
20	B31 B32 B33 B34 Spring Frame and Gold Star Clubmans	65-5903	Rear brake shoe lining	2
21	B31 B33 Spring Frame	35-6436	Rear brake shoe lining rivet	14
	B32 B34	15-817	Rear transmission chain	1
22	Spring Frame and Gold Star Clubmans	24-8713	Rear transmission chain	1
23	B31 B32 B33 B34 Spring Frame and Gold Star Clubmans	89-3022	Brake drum and chainwheel ball bearing	1
24	B31 B32 B33 B34 Spring Frame and Gold Star Clubmans	67-6072	Ball bearing shim	1
25	B31 B32 B33 B34 Spring Frame and Gold Star Clubmans	67-6067	Ball bearing retaining ring	1
26	B31 B32 B33 B34 Spring Frame and Gold Star Clubmans	67-6101	Driving flange	1
27	B31 B32 B33 B34 Spring Frame and Gold Star Clubmans	67-6076	Rear hub bearing lockring	1
28	B31 B33 Spring Frame	65-5883	Rear hub bearing	1
29	B32 B34 Spring Frame	67-6005	Rear wheel rim	1
	Gold Star Clubmans	65-6298	Rear wheel rim	1
	Gold Star Clubmans	65-6306	Rear wheel rim	1
30	B31 B32 B33 B34 Spring Frame and Gold Star Clubmans	27-6813	Rear wheel spoke nipple	40
31	B31 B32 B33 B34 Spring Frame and Gold Star Clubmans	65-6303	Rear wheel spoke (short)	20
32	B31 B32 B33 B34 Spring Frame and Gold Star Clubmans	15-5290	Rear hub grease nipple	1
33	B31 B32 B33 B34 Spring Frame and Gold Star Clubmans	65-5883	Rear hub bearing	1
34	B31 B32 B33 B34 Spring Frame and Gold Star Clubmans	67-6077	Hub collar (right-hand)	1
35	B31 B32 B33 B34 Spring Frame and Gold Star Clubmans	67-6076	Rear hub bearing lockring	1
36	B31 B32 B33 B34 Spring Frame and Gold Star Clubmans	67-6075	Rear hub felt washer	1
37	B31 B32 B33 B34 Spring Frame and Gold Star Clubmans	67-6128	Hub shell cover assembled	1
38	B31 B32 B33 B34 Spring Frame and Gold Star Clubmans	67-6066	Hub distance piece	1
39	B31 B32 B33 B34 Spring Frame and Gold Star Clubmans	65-6302	Rear wheel spoke (long)	20

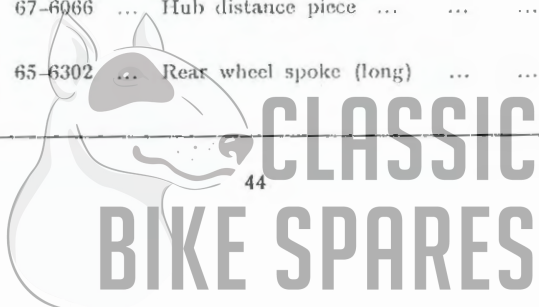

REAR HUB and WHEEL FITTINGS

"B" Group (Spring Frame) and Gold Star (Clubman's) 350c.c. and 500c.c.

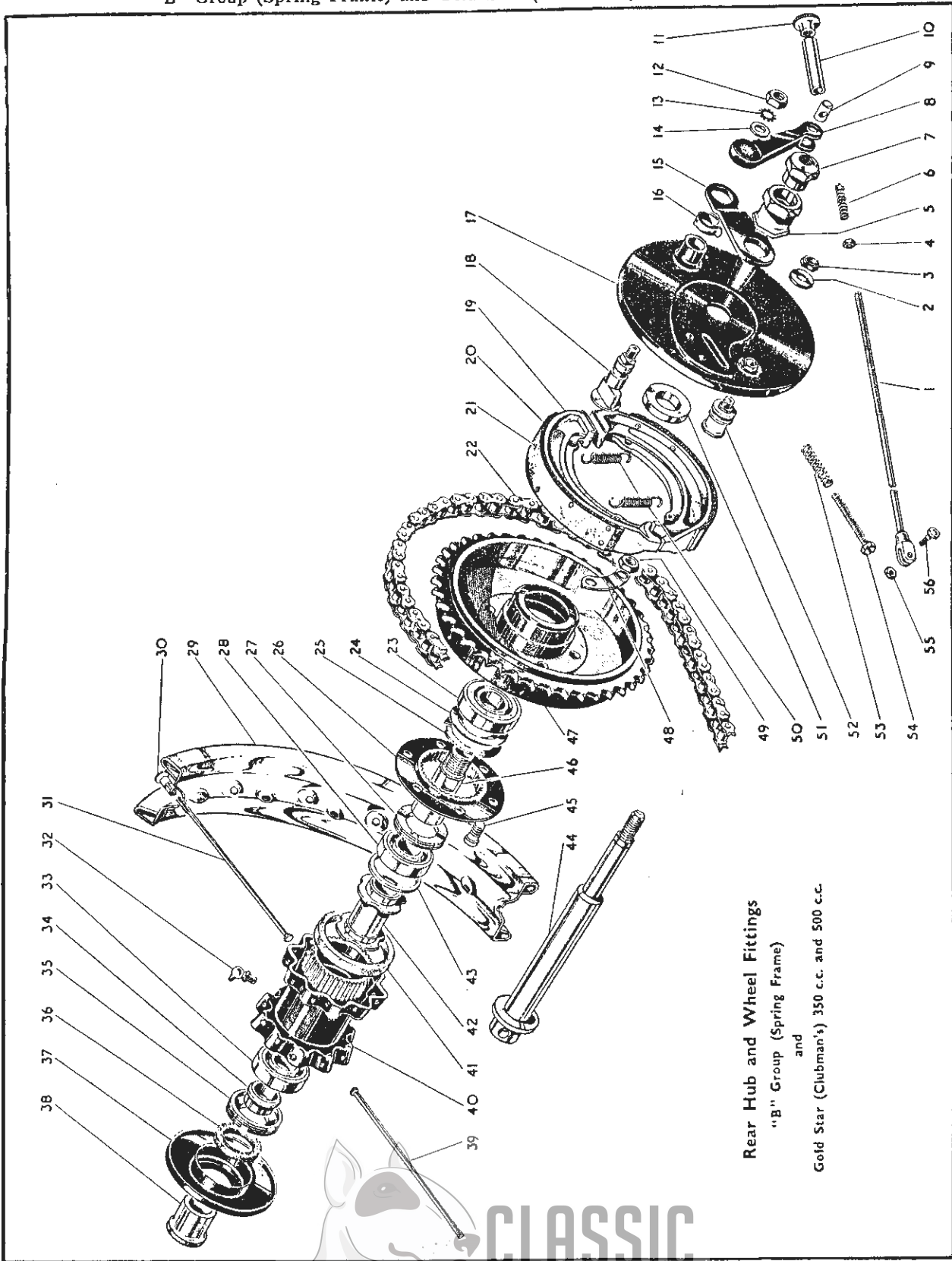

Rear Hub and Wheel Fittings
"B" Group (Spring Frame)
and
Gold Star (Clubman's) 350 c.c. and 500 c.c.

Plate 12—continued REAR HUB and WHEEL FITTINGS

“B” Group (Spring Frame) and Gold Star (Clubman's) 350c.c. and 500c.c.

Plate Ref. Number.	Models.	Part No.	Description.	Number per set.
40	B31 B32 B33 B34 Spring Frame and Gold Star Clubmans	67-6126	Rear hub shell complete with bearings	1
	B31 B32 B33 B34 Spring Frame and Gold Star Clubmans	67-6127	Rear hub shell less bearings	1
41	B31 B32 B33 B34 Spring Frame and Gold Star Clubmans	67-6051	Rear hub shell washer (rubber)	1
42	B31 B32 B33 B34 Spring Frame and Gold Star Clubmans	67-6061	Bearing distance tube and retainers	1
43	B31 B32 B33 B34 Spring Frame and Gold Star Clubmans	65-5884	Rear hub bearing thrust washer	1
44	B31 B32 B33 B34 Spring Frame and Gold Star Clubmans	67-6164	Rear hub spindle	1
45	B31 B32 B33 B34 Spring Frame and Gold Star Clubmans	67-6038	Brake drum securing bolt	6
46	B31 B32 B33 B34 Spring Frame and Gold Star Clubmans	67-6060	Rear hub bearing sleeve	1
47	B31 B32 B33 B34 Spring Frame and Gold Star Clubmans	65-6294	Rear brake drum and chainwheel	1
48	B31 B32 B33 B34 Spring Frame and Gold Star Clubmans	67-6039	Brake drum securing bolt locking strip	3
49	B31 B32 B33 B34 Spring Frame and Gold Star Clubmans	3-720	Brake drum securing bolt nut	6
50	B31 B32 B33 B34 Spring Frame and Gold Star Clubmans	65-5904	Rear brake shoe spring	2
51	B31 B32 B33 B34 Spring Frame and Gold Star Clubmans	67-6078	Hub collar (left-hand)	1
52	B31 B32 B33 B34 Spring Frame and Gold Star Clubmans	65-5899	Rear brake shoe fulcrum pin	1
53	B31 B32 B33 B34 Spring Frame and Gold Star Clubmans	15-1312	Rear wheel adjusting spring	2
54	B31 B32 B33 B34 Spring Frame and Gold Star Clubmans	66-4603	Rear wheel adjusting screw...	2
55	B31 B32 B33 B34 Spring Frame and Gold Star Clubmans	2-510	Rear brake rod fork screw	1
56	B31 B32 B33 B34 Spring Frame and Gold Star Clubmans	2-443	Rear brake rod fork screw nut	1

Plate 13

REAR HUB and WHEEL FITTINGS

“B” Group (Rigid Frame)

Plate Ref. Number.	Models.	Part No.	Description.	Number per set.
1	B31 B32 B33 B34	29-7365	Rear brake rod with toggle end	1
2	B31 B32 B33 B34	2-2395	Rear brake rod nut	1
3	B31 B32 B33 B34	15-1312	Rear brake rod spring	1
4	B31 B32 B33 B34	2-46	Rear brake anchor strap nut	3
5	B31 B32 B33 B34	65-6274	Rear brake rod swivel pin	1
6	B31 B32 B33 B34	29-7368	Rear brake adjuster ferrule	1

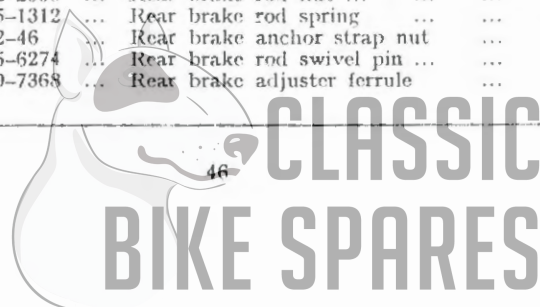
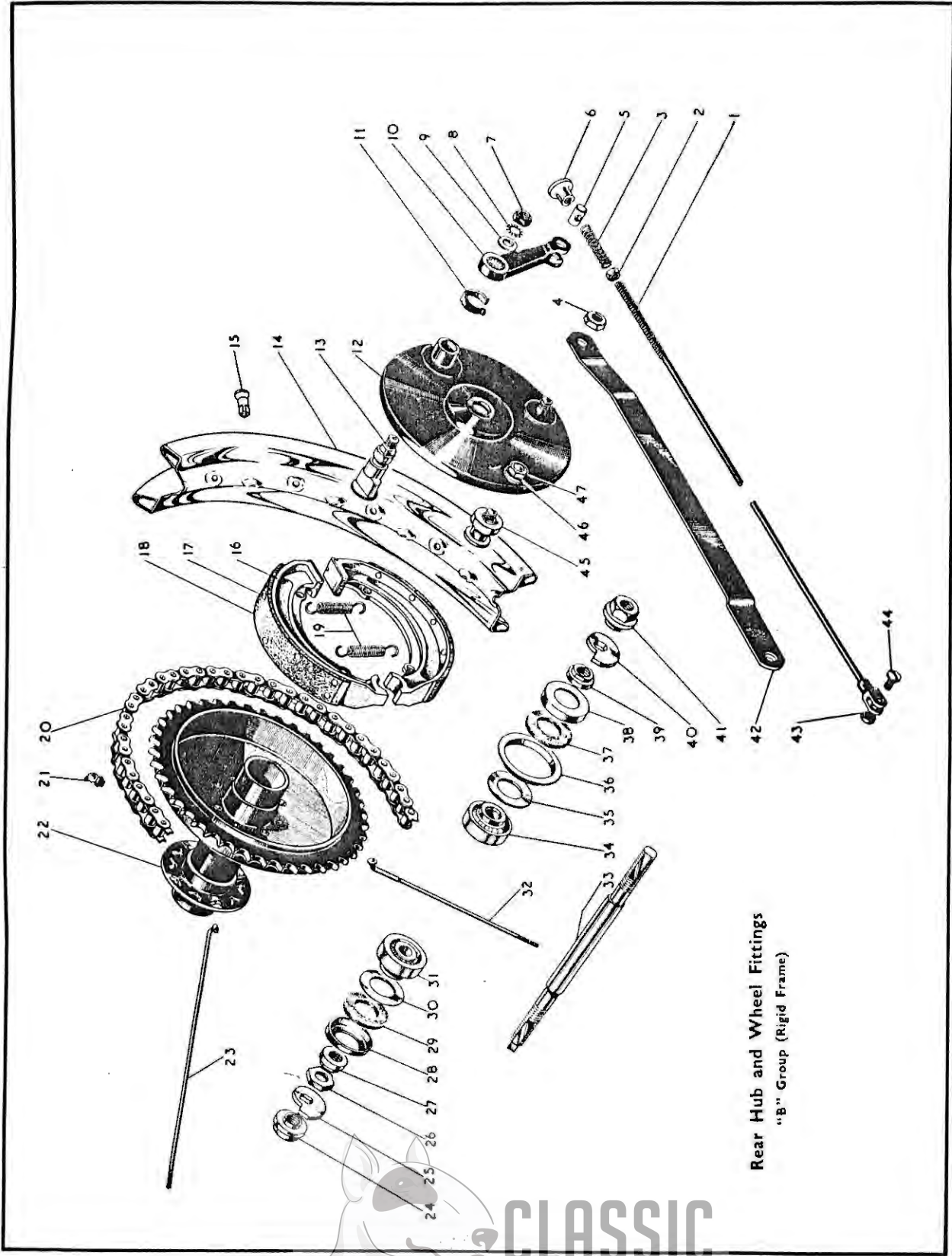

Plate 13.

REAR HUB and WHEEL FITTINGS

"B" Group (Rigid Frame)



Rear Hub and Wheel Fittings
"B" Group (Rigid Frame)

REAR HUB and WHEEL FITTINGS

"B" Group (Rigid Frame)

Plate Ref. Number.	Models.	Part No.	Description.	Number per set.
7	B31 B32 B33 B34	2-440	Rear brake operating lever nut	1
8	B31 B32 B33 B34	66-4708	Rear brake operating lever washer	1
9	B31 B32 B33 B34	15-431	Rear brake operating lever washer	1
10	B31 B32 B33 B34	65-6279	Rear brake operating lever	1
11	B31 B32 B33 B34	65-5674	Rear brake cam bearing oil hole clip	1
12	B31 B33	65-6276	Rear brake cover plate	1
	B32 B34	65-6276	Rear brake cover plate	1
13	B31 B32 B33 B34	65-5905	Rear brake shoe cam	1
14	B31 B33	65-6263	Rear wheel rim	1
	B32 B34	65-6263	Rear wheel rim	1
15	B31 B32 B33 B34	27-6810	Spoke nipple	40
16	B31 B32 B33 B34	65-5901	Brake shoe with lining	2
17	B31 B32 B33 B34	35-6436	Brake shoe rivet	14
18	B31 B32 B33 B34	65-5903	Brake shoe lining	2
19	B31 B32 B33 B34	65-5904	Brake shoe spring	2
20	B31 B33	65-9191	Transmission chain	1
	B32 B34	15-8967	Transmission chain	1
21	B31 B32 B33 B34	15-5290	Rear hub grease nipple	1
22	B31 B32 B33 B34	65-6289	Hub shell with bearings	1
23	B31 B32 B33 B34	24-7012	Wheel spoke (long)	20
24	B31 B32 B33 B34	65-6136	Hub spindle nut	1
25	B31 B32 B33 B34	27-6738	Rear hub adjusting plate	1
26	B31 B32 B33 B34	27-6716	Rear hub spindle locknut	1
27	B31 B32 B33 B34	65-5670	Rear hub adjusting sleeve	1
28	B31 B32 B33 B34	29-5710	Rear hub bearing retaining cup	1
29	B31 B32 B33 B34	24-7047	Rear hub washer (felt)	1
30	B31 B32 B33 B34	29-5715	Rear hub bearing retaining washer	1
31	B31 B32 B33 B34	24-7058	Rear hub bearing	1
32	B31 B32 B33 B34	65-6027	Wheel spoke (short)	20
33	B31 B32 B33 B34	65-6161	Rear hub spindle	1
34	B31 B32 B33 B34	24-7058	Rear hub bearing	1
35	B31 B32 B33 B34	29-5715	Rear hub bearing retaining washer	1
36	B31 B32 B33 B34	29-5905	Hub grease flinger washer	1
37	B31 B32 B33 B34	24-7047	Rear hub washer (felt)	1
38	B31 B32 B33 B34	29-5710	Rear hub bearing retaining cup	1
39	B31 B32 B33 B34	65-5670	Rear hub adjusting sleeve	1
40	B31 B32 B33 B34	27-6738	Rear hub adjusting plate	1
41	B31 B32 B33 B34	65-6136	Rear hub spindle nut	1
42	B31 B33	65-7062	Rear brake anchor strap	1
	B32 B34	65-7064	Rear brake anchor strap	1
43	B31 B32 B33 B34	2-443	Rear brake rod toggle end nut	1
44	B31 B32 B33 B34	2-510	Rear brake rod toggle end screw	1
45	B31 B32 B33 B34	65-5899	Rear brake shoe fulcrum pin	1
46	B31 B32 B33 B34	24-8045	Fulcrum pin washer	1
47	B31 B32 B33 B34	24-5860	Brake shoe fulcrum pin locknut	1

Plate 14

ACCESSORIES

"B" Group (Rigid Frame)

Plate Ref. Number.	Models.	Part No.	Description.	Number per set.
1	B32 B34 Rigid	15-7161	Front mudguard stay fixing bolt	4
	B31 B33 Rigid	15-7161	Front mudguard stay fixing bolt	2
2	B32 B34 Rigid	27-8560	Front mudguard stay fixing bolt washer	4
	B31 B33 Rigid	27-8560	Front mudguard stay fixing bolt washer	2
3	B32 B34 Rigid	2-2395	Front mudguard stay fixing bolt nut	4
	B31 B33 Rigid	2-2395	Front mudguard stay fixing bolt nut	2
4	B32 B34 Rigid	2-1462	Front mudguard stay fixing bolt washer (spring)	4
	B31 B33 Rigid	2-1462	Front mudguard stay fixing bolt washer (spring)	2
5	B31-2-3-4 Rigid	2-2395	Front mudguard support bridge fixing screw nut	2
6	B31-2-3-4 Rigid	2-1462	Front mudguard support bridge fixing screw washer (spring)	2
7	B31-2-3-4 Rigid	66-7518	Front mudguard support bridge fixing screw washer (fibre)	2
8	B31-2-3-4 Rigid	2-49	Support bridge bottom fixing bolt nut	4
9	B31-2-3-4 Rigid	36-382	Support bridge bottom fixing bolt washer (shakeproof)	4

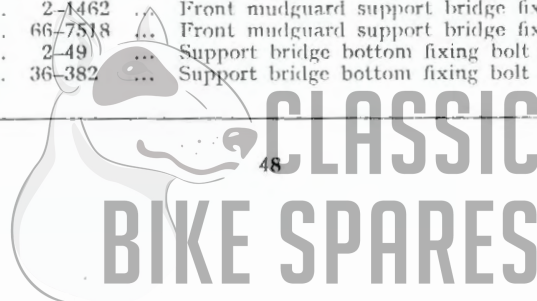
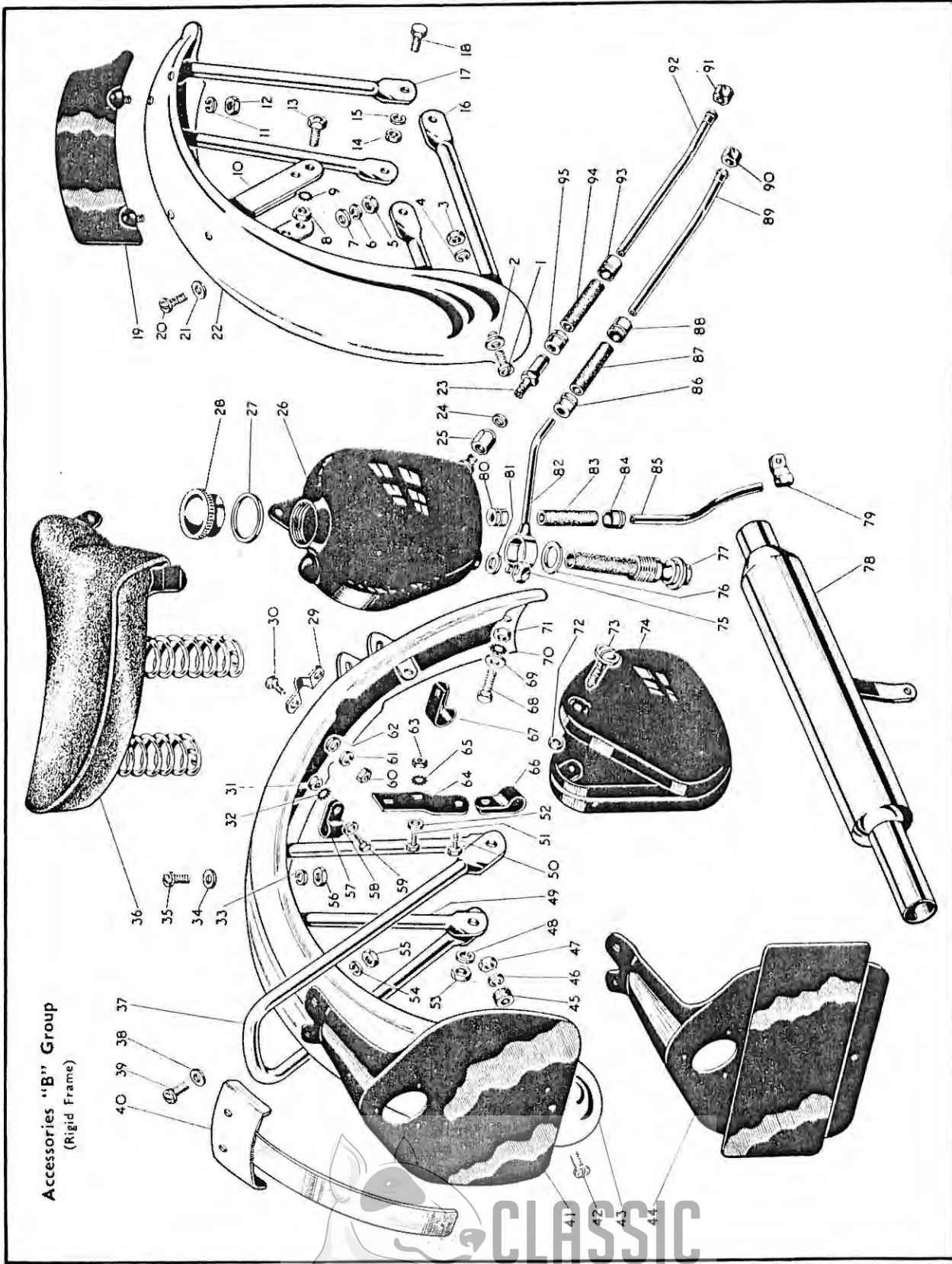

Plate 14.

ACCESSORIES

“B” Group (Rigid Frame)



Accessories
“B” Group

ACCESSORIES

"B" Group (Rigid Frame)

Plate Ref. Number.	Models.	Part No.	Description.	Number per set.
10	B32 B34 Rigid	65-6613	Front mudguard support bridge	1
11	B31-2-3-4 Rigid	2-1462	Front number plate fixing stud washer (spring)	2
12	B31-2-3-4 Rigid	2-2395	Front number plate fixing stud nut	2
13	B31-2-3-4 Rigid	28-2338	Support bridge bottom fixing bolt	4
14	B32 B34 Rigid	2-1616	Front mudguard stay fork end bolt nut	4
	B31 B33 Rigid	2-1616	Front mudguard stay fork end bolt nut	2
15	B32 B34 Rigid	24-8784	Front mudguard stay fork end bolt washer (spring)	4
	B31 B33 Rigid	24-8784	Front mudguard stay fork end bolt washer (spring)	2
16	B32 B34 Rigid	65-6614	Front mudguard bottom stay	1
17	B32 B34 Rigid	65-6612	Front mudguard stay (top)	1
18	B32 B34 Rigid	15-7354	Front mudguard stay fork end bolt	4
	B31 B33 Rigid	15-7354	Front mudguard stay fork end bolt	2
19	B31-2-3-4 Rigid	65-6576	Front number plate complete	1
20	B31-2-3-4 Rigid	15-7161	Front mudguard support bridge fixing screw	2
21	B31-2-3-4 Rigid	27-8560	Front mudguard support bridge fixing screw washer (plain)	2
22	B32 B34 Rigid	65-6611	Front mudguard with fixed fittings	1
23	B31-2-3-4 Rigid	65-8420	Oil return pipe connection	1
24	B31-2-3-4 Rigid	65-8421	Oil return pipe nut washer (fibre)	1
25	B31-2-3-4 Rigid	65-8424	Oil return pipe nut	1
*26	B31-2-3-4 Rigid	65-8479	Oil tank with fixed fittings	1
27	B31-2-3-4 Rigid	67-42	Oil tank filler cap washer	1
28	B31-2-3-4 Rigid	65-8500	Oil tank filler cap	1
29	B32 B34 Rigid	2-2276	Mudguard backstay bridge bracket	1
30	B32 B34 Rigid	2-2273	Mudguard backstay bridge bracket bolt	2
31	B32 B34 Rigid	2-2395	Toolbox clip bolt nut	3
32	B32 B34 Rigid	29-541	Toolbox clip bolt washer (shakeproof)	3
33	B32 B34 Rigid	2-1462	Rear mudguard stay bolt washer (spring)	2
34	B32 B34 Rigid	27-8560	Rear mudguard stay bolt washer (plain)	2
35	B32 B34 Rigid	15-7161	Rear mudguard stay bolt	2
36	B31-2-3-4 Rigid	65-9100	Saddle	1
37	B32 B34 Rigid	65-6852	Lifting handle complete	1
38	B32 B34 Rigid	27-8560	Lifting handle fixing screw washer	2
39	B32 B34 Rigid	15-7161	Lifting handle fixing screw	2
40	B32 B34 Rigid	65-6864	Rear mudguard strengthening plate complete	1
*41	B32 B34 Rigid	65-6827	Rear number plate complete	1
*	B31 B33 Rigid	65-6825	Rear number plate complete	1
	B31 B32 Rigid	29-6885	Rear number plate (1949/50)	1
42	B31-2-3-4 Rigid	1-5945	Rear number plate bottom fixing screw	1
43	B32 B34 Rigid	65-6858	Rear mudguard with fixed fittings	1
44	B32 B34 Rigid	65-6828	Rear number plate complete (South Australia)	1
	B31 B33 Rigid	65-6826	Rear number plate complete (South Australia)	1
45	B31-2-3-4 Rigid	15-7383	Rear number plate bottom fixing rubber	1
46	B31-2-3-4 Rigid	2-1462	Rear number plate bottom fixing screw washer (spring)	1
47	B31-2-3-4 Rigid	2-2395	Rear number plate bottom fixing screw nut	1
48	B31-2-3-4 Rigid	2-2903	Mudguard stay and lifting handle washer (spring)	2
49	B32 B34 Rigid	65-6851	Rear mudguard stay	1
50	B32 B34 Rigid	2-1354	Toolbox clip and bracket bolt	1
51	B32 B34 Rigid	2-204	Toolbox bracket bolt	2
52	B32 B34 Rigid	2-525	Toolbox bracket bolt washer	2
53	B31-2-3-4 Rigid	2-449	Mudguard stay and lifting handle nut	2
54	B32 B34 Rigid	2-1462	Lifting handle fixing screw washer (spring)	2
55	B32 B34 Rigid	2-2395	Lifting handle fixing screw nut	2
56	B32 B34 Rigid	2-2395	Rear mudguard stay bolt nut	2
57	B32 B34 Rigid	66-7353	Toolbox clip (mudguard stay)	1
58	B32 B34 Rigid	2-525	Toolbox clip bolt washer (plain)	3
59	B32 B34 Rigid	2-204	Toolbox clip bolt	2
60	B32 B34 Rigid	2-2395	Mudguard backstay bridge bracket bolt nut	2
61	B32 B34 Rigid	2-1462	Mudguard backstay bridge bracket bolt washer (spring)	2
62	B32 B34 Rigid	27-8560	Mudguard backstay bridge bracket bolt washer (plain)	2
63	B32 B34 Rigid	2-2395	Toolbox bracket bolt nut	2
64	B32 B34 Rigid	65-9085	Toolbox fixing bracket	1
65	B32 B34 Rigid	29-541	Toolbox bracket bolt washer (shakeproof)	2
66	B32 B34 Rigid	27-9001	Toolbox clip (backstay)	1
67	B32 B34 Rigid	27-9001	Toolbox clip (backstay)	1
68	B31-2-3-4 Rigid	27-6312	Rear mudguard chainstay bridge screw	1
69	B31-2-3-4 Rigid	2-2899	Rear mudguard chainstay bridge screw washer (plain)	1
70	B31-2-3-4 Rigid	36-382	Rear mudguard chainstay bridge screw washer (shakeproof)	1
71	B31-2-3-4 Rigid	2-49	Rear mudguard chainstay bridge screw nut	1
72	B31-2-3-3 Rigid	2-1027	Toolbox lid fixing screw nut	1
73	B31-2-3-4 Rigid	29-9132	Toolbox lid fixing screw complete	1
*74	B32 B34 Rigid	65-9250	Toolbox complete	1
75	B31-2-3-4 Rigid	2-84	Oil tank drain plug	1

*Fitted on and after Frame Number ZB31-19001.



Plate 14—continued

ACCESSORIES

"B" Group (Rigid Frame)

Plate Ref. Number.	Models.	Part No.	Description.	Number per set.
76	B31-2-3-4 Rigid	29-7971	Oil feed pipe banjo union washer	2
77	B31-2-3-4 Rigid	29-7962	Oil tank filter	1
*78	B32 B34 Rigid	65-2845	Silencer complete	1
79	B31-2-3-4 Rigid	66-8340	Oil tank breather pipe clip	1
80	B31-2-3-4 Rigid	65-8422	Oil tank breather pipe ferrule	1
81	B31-2-3-4 Rigid	2-100	Oil tank drain plug washer	1
*82	B31-2-3-4 Rigid	65-8461	Oil feed pipe complete (tank)	1
83	B31-2-3-4 Rigid	65-2060	Oil tank breather pipe connection	1
84	B31-2-3-4 Rigid	65-8422	Oil tank breather pipe ferrule	1
85	B31-2-3-4 Rigid	65-8499	Oil tank breather pipe extension	1
86	B31-2-3-4 Rigid	65-8422	Oil feed pipe ferrule	1
87	B31-2-3-4 Rigid	65-2060	Oil feed pipe connection	1
88	B31-2-3-4 Rigid	65-8422	Oil feed pipe ferrule	1
89	B31-2-3-4 Rigid	65-8465	Oil feed and scavenge pipe	1
90	B31-2-3-4 Rigid	66-8332	Oil pipe nipple nut	1
91	B31-2-3-4 Rigid	66-8332	Oil pipe nipple nut	1
92	B31-2-3-4 Rigid	65-8465	Oil return pipe	1
93	B31-2-3-4 Rigid	65-8422	Oil return pipe ferrule	1
94	B31-2-3-4 Rigid	65-2060	Oil return pipe extension	1
95	B31-2-3-4 Rigid	65-8422	Oil return pipe ferrule	1

Plate 15

ACCESSORIES

"B" Group (Rigid Frame)

Plate Ref. Number.	Models.	Part No.	Description.	Number per set.
1	B31 B33 Rigid	65-6608	Front mudguard stand complete	1
2	B31 B33 Rigid	15-447	Front stand mudguard fixing bolt nut	2
3	B31 B33 Rigid	2-1934	Front stand fixing bolt (fork end)	2
4	B31 B33 Rigid	24-8784	Front stand fixing bolt washer (spring) (fork end)	2
5	B31 B33 Rigid	2-1616	Front stand fixing bolt nut (fork end)	2
6	B31 B33 Rigid	65-6607	Front mudguard stay	1
7	B31 B33 Rigid	65-6606	Front mudguard support bridge	1
8	B31 B33 Rigid	65-6605	Front mudguard with fixed fittings	1
9	B31-2-3-4 Rigid	65-8317	Petrol tank badge screw	2
10	B31-2-3-4 Rigid	65-8157	Petrol tank badge (nearside)	1
	B31-2-3-4 Rigid	65-8158	Petrol tank badge (offside)	1
11	B31-2-3-4 Rigid	65-8326	Petrol tank fixing bolt (front)	1
12	B31-2-3-4 Rigid	29-7898	Petrol tank filler cap	1
13	B31-2-3-4 Rigid	2-449	Petrol tank fixing bolt nut (front)	1
14	B31-2-3-4 Rigid	66-4707	Petrol tank fixing bolt washer (shakeproof) (front)	1
15	B31-2-3-4 Rigid	65-8161	Petrol tank	1
16	B31-2-3-4 Rigid	27-8553	Petrol tap	1
17	B31-2-3-4 Rigid	65-8150	Petrol pipe complete	1
18	B31 B33 Rigid	2-1354	Front stand mudguard fixing bolt	2
19	B31 B33 Rigid	2-2273	Toolbox and mudguard fixing bolt	2
20	B31 B33 Rigid	2-525	Toolbox and mudguard fixing bolt washer (plain)	2
21	B31 B33 Rigid	65-6770	Rear mudguard backstay bridge bracket	1
22	B31 B33 Rigid	2-204	Rear mudguard backstay bridge bracket screw	2
23	B31 B33 Rigid	65-7715	Rear chainguard	1
24	B31-2-3-4 Rigid	2-525	Rear chainguard fixing nut washer	1
25	B31-2-3-4 Rigid	2-2395	Rear chainguard fixing nut	1
26	B31 B33 Rigid	2-1354	Rear mudguard vertical stay screw	2
27	B31 B33 Rigid	2-1374	Rear mudguard vertical stay screw washer	2
28	B31 B33 Rigid	2-2903	Rear mudguard vertical stay screw washer (spring)	2
29	B31 B33 Rigid	2-2395	Rear mudguard vertical stay screw nut	2
30	B31 B33 Rigid	65-6857	Rear mudguard with fixed fittings	1
31	B31 B33 Rigid	65-6839	Lifting handle and rear mudguard stay	1
32	B31 B33 Rigid	66-6740	Rear mudguard tail bolt complete	2
33	B31 B33 Rigid	15-7161	Rear number plate top fixing screw	2
34	B31 B33 Rigid	27-8560	Rear number plate top fixing screw washer (plain)	2
35	B31 B33 Rigid	2-1354	Lifting handle and rear mudguard stay screw	2
36	B31 B33 Rigid	2-1374	Lifting handle and rear mudguard stay screw washer	2
37	B31 B33 Rigid	2-2395	Lifting handle and rear mudguard stay screw nut	2
38	B31 B33 Rigid	65-6836	Rear mudguard tail	1
39	B31 B33 Rigid	2-204	Rear mudguard bottom stay bolt	2

*Fitted on and after Frame Number ZB31-19001.



ACCESSORIES
"B" Group (Rigid Frame)

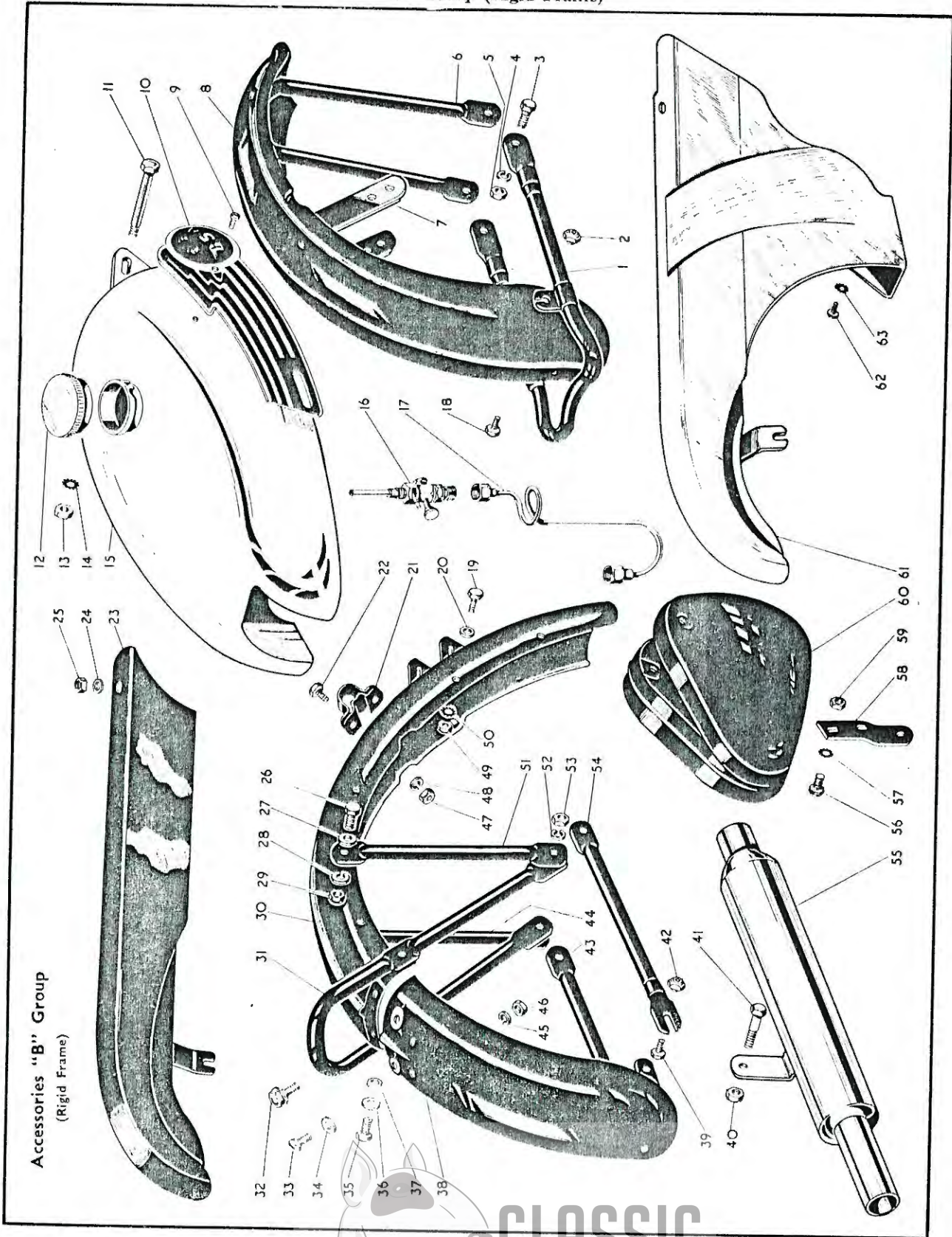

Plate 15—continued

ACCESSORIES

"B" Group (Rigid Frame)

Plate Ref. Number.	Models.	Part No.	Description.	Number per set.
40	B31-2-3-4 Rigid	2-449	Silencer fixing bracket bolt nut	1
41	B31-2-3-4 Rigid	3-1399	Silencer fixing bracket bolt	1
42	B31 B33 Rigid	15-447	Rear mudguard bottom stay bolt nut	2
43	B31 B33 Rigid	65-6842	Rear mudguard bottom stay complete (nearside)	1
44	B31 B33 Rigid	65-6838	Rear mudguard vertical stay (nearside)	1
45	B31 B33 Rigid	2-1462	Rear number plate top fixing screw washer (spring)	2
46	B31 B33 Rigid	2-2395	Rear number plate top fixing screw nut	2
47	B31 B33 Rigid	2-2395	Mudguard backstay bridge bracket screw nut	2
48	B31 B33 Rigid	2-1462	Mudguard backstay bridge bracket screw washer (spring)	2
49	B31 B33 Rigid	2-2395	Toolbox and mudguard fixing bolt nut	2
50	B31 B33 Rigid	29-541	Toolbox and mudguard fixing bolt washer (shakeproof)	2
51	B31 B33 Rigid	65-6837	Rear mudguard vertical stay (offside)	1
52	B31 B33 Rigid	2-2903	Rear mudguard stay fixing stud nut washer (spring)	2
53	B31 B33 Rigid	2-449	Rear mudguard stay fixing stud nut	2
54	B31 B33 Rigid	65-6840	Rear mudguard bottom stay complete (offside)	1
55	B31 B33 Rigid	65-2754	Silencer complete	1
56	B31 B33 Rigid	15-7161	Toolbox strap bolt	2
57	B31 B33 Rigid	29-541	Toolbox strap bolt washer (shakeproof)	2
58	B31 B33 Rigid	65-9085	Toolbox fixing strap	1
59	B31 B33 Rigid	2-2395	Toolbox strap bolt nut	2
60	B31 B33 Rigid	65-9080	Toolbox complete	1
61	B32 B34 Rigid	65-7718	Rear chainguard	1
62	B32 B34 Rigid	24-7065	Chainguard and anchor strap screw	1
63	B32 B34 Rigid	29-3319	Chainguard and anchor strap washer (shakeproof)	1

Plate 16

ACCESSORIES

"B" Group and Gold Star (Clubman's) 350c.c. and 500c.c.

Plate Ref. Number.	Models.	Part No.	Description.	Number per set.
1	B32 B34 and Gold Star Clubmans	65-7725	Rear chainguard with pump clips	1
2	B31 B33 Spring and Gold Star Clubmans	1-5069	Rear chainguard fixing bolt	1
3	B31 B33 Spring and Gold Star Clubmans	2-923	Rear chainguard fixing bolt washer (plain)	1
4	B31 B33 Spring and Gold Star Clubmans	36-382	Rear chainguard fixing bolt washer (shakeproof)	1
5	B31 B33 Spring and Gold Star Clubmans	2-2395	Rear chainguard fixing bolt nut	1
6	Gold Star Clubmans	67-9052	Inflator	1
7	Gold Star Clubmans	67-9087	Dual seat	1
8	Gold Star Clubmans	27-6037	Seat to mudguard fixing bolt	2
9	Gold Star Clubmans	2-923	Seat to mudguard fixing bolt washer	2
10	Gold Star Clubmans	36-382	Seat to mudguard fixing bolt washer	2
11	Gold Star Clubmans	2-49	Seat to mudguard fixing bolt nut	2
12	Gold Star Clubmans	65-9237	Rear support strap	1
13	Gold Star Clubmans	2-129	Support strap fixing bolt	5
14	Gold Star Clubmans	35-33	Support strap fixing bolt washer	8
15	Gold Star Clubmans	2-923	Rear support strap fixing bolt washer	9
16	B31 B33 Spring and Gold Star Clubmans	15-7161	Bottom chainguard fixing bolt	1
17	B31 B33 Spring and Gold Star Clubmans	2-1462	Bottom chainguard fixing bolt washer	1
18	B31 B33 Spring and Gold Star Clubmans	27-8560	Bottom chainguard fixing bolt washer	1
19	Gold Star Clubmans	65-6986	Chainguard steady bracket	1
20	Gold Star Clubmans	2-2395	Bottom chainguard fixing bolt nut	1
21	B31 B33 Spring and Gold Star Clubmans	2-525	Chainguard, chaincase fixing bolt washer	1
22	B31 B33 Spring and Gold Star Clubmans	2-1462	Chainguard, chaincase fixing bolt washer	1
23	Gold Star Clubmans	2-2395	Chainguard, chaincase fixing nut	1

Accessorie

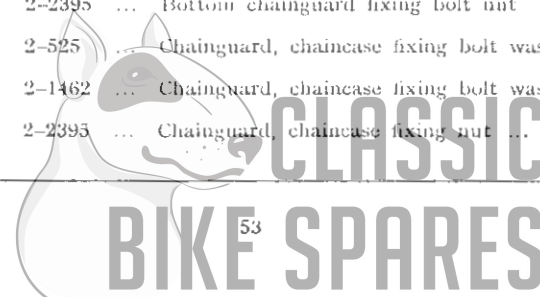

ACCESSORIES

"B" Group and Gold Star (Clubman's) 350 c.c. and 500 c.c.

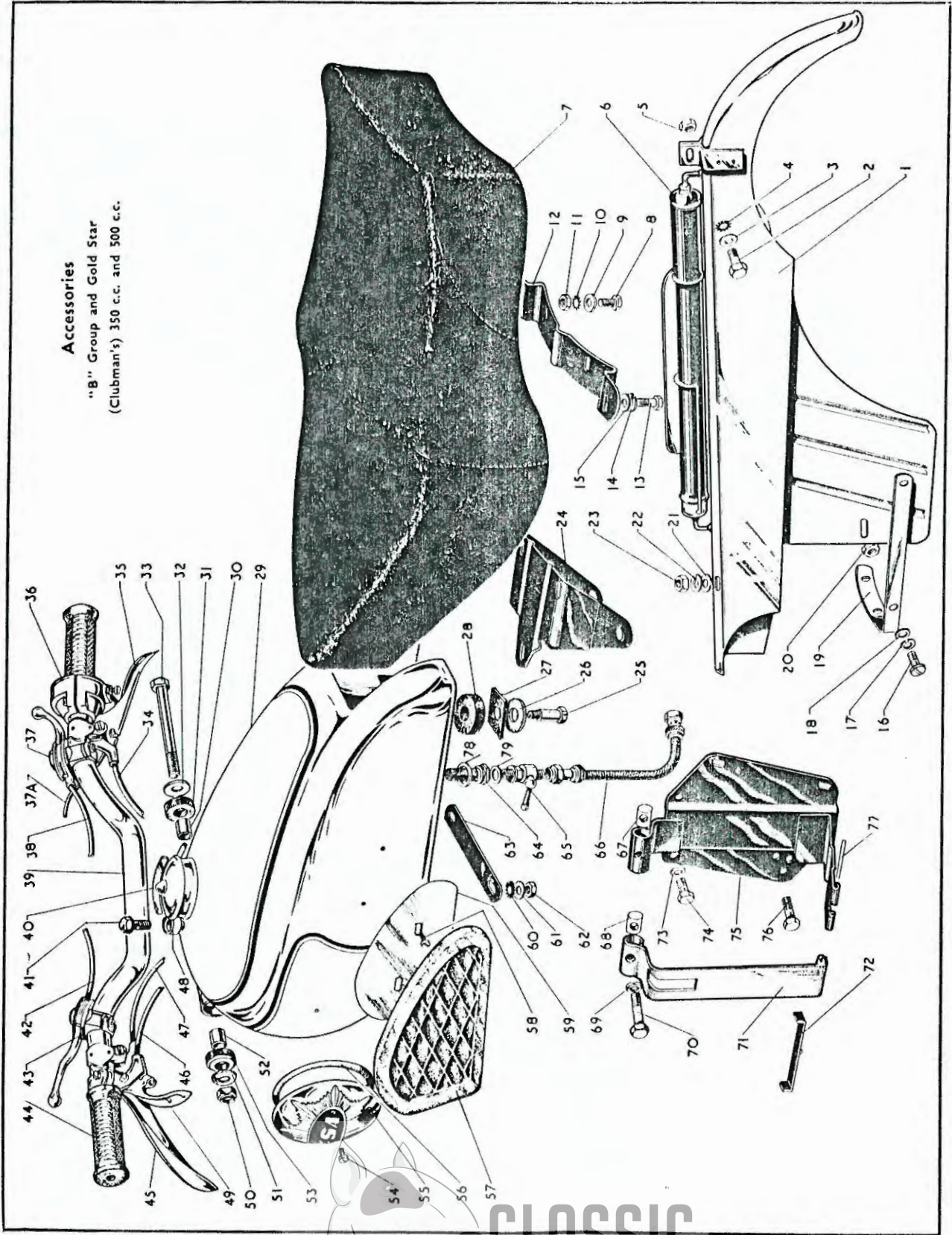

Accessories

"B" Group and Gold Star
(Clubman's) 350 c.c. and 500 c.c.

Plate 16—continued

ACCESSORIES

"B" Group and Gold Star (Clubman's) 350c.c. and 500c.c.

Plate Ref. Number.	Models.	Part No.	Description.	Number per set.
24	... Gold Star Clubmans ... B31 B32 B33 B34 and ...	65-9236	... Front support bracket ...	1
25	... Gold Star Clubmans ... B31 B32 B33 B34 and ...	66-8089	... Petrol tank rear support bolt ...	2
26	... Gold Star Clubmans ... B31 B32 B33 B34 and ...	30-660	... Petrol tank support bolt washer ...	2
27	... Gold Star Clubmans ... B31 B32 B33 B34 and ...	65-8032	... Petrol tank rear support bolt rubber ...	2
28	... Gold Star Clubmans ...	36-4140	... Petrol tank rear support rubber ...	2
29	... Gold Star Clubmans ...	65-8197	... Petrol tank (three gallon capacity) ...	1
		65-8199	... Petrol tank (four gallon capacity) ...	1
30	... Gold Star Clubmans ...	65-8192	... Petrol tank front support sleeve ...	2
31	... Gold Star Clubmans ...	65-8191	... Petrol tank front support rubber ...	2
32	... Gold Star Clubmans ...	27-5676	... Petrol tank front support bolt washer ...	2
33	... Gold Star Clubmans ... B31 B32 B33 B34 ...	21-5532	... Petrol tank front support bolt ...	1
		67-8610	... Front brake cable and cover complete ...	1
34	... Gold Star Clubmans ... B31 B32 B33 B34 and ...	65-8675	... Front brake cable and cover complete ...	1
35	... Gold Star Clubmans ... B31 B32 B33 B34 and ...	29-8810	... Front brake control complete (less cable and cover) ...	1
36	... Gold Star Clubmans ... B31 B32 B33 B34 and ...	65-8501	... Throttle twist grip complete (less cable and cover) ...	1
37	... Gold Star Clubmans ... B31 B32 B33 B34 and ...	66-8896	... Air control complete (less cable and cover) ...	1
37A	... Gold Star Clubmans ... B31 B32 B33 B34 and ...	65-8832	... Throttle twist grip cable and cover complete ...	1
38	... Gold Star Clubmans ...	65-8836	... Air control cable and cover complete ...	1
39	... Gold Star Clubmans ... B31 B32 B33 B34 ...	65-4965	... Handlebar (less controls) ...	1
		65-4960	... Handlebar (less controls) ...	1
40	... Gold Star Clubmans ...	66-8351	... Petrol Filler cap ...	1
41	... Gold Star Clubmans ... B31 B32 B33 B34 and ...	65-306	... Petrol tank breather pipe union screw ...	1
42	... Gold Star Clubmans ... B31 B32 B33 B34 and ...	65-8714	... Ignition cable and cover complete ...	1
43	... Gold Star Clubmans ...	66-8810	... Ignition control lever complete (less cable and cover) ...	1
44	... Gold Star Clubmans ... B31 B32 B33 B34 and ...	65-8502	... Rubber for left-hand bar ...	1
45	... Gold Star Clubmans ... B31 B32 B33 B34 and ...	29-8820	... Clutch control lever complete (less cable and cover) ...	1
46	... Gold Star Clubmans ... B31 B32 B33 B34 and ...	65-8795	... Exhaust lifter cable and cover complete ...	1
47	... Gold Star Clubmans ...	65-8680	... Clutch control cable and cover complete ...	1
48	... Gold Star Clubmans ... B31 B32 B33 B34 and ...	65-8362	... Breather pipe complete ...	1
49	... Gold Star Clubmans ...	66-8513	... Exhaust control lever (less cable and cover) ...	1
50	... Gold Star Clubmans ...	65-8181	... Petrol tank front support bolt nut ...	1
51	... Gold Star Clubmans ...	27-5676	... Petrol tank front support bolt washer ...	2
52	... Gold Star Clubmans ...	65-8192	... Petrol tank front support sleeve ...	2
53	... Gold Star Clubmans ...	65-8191	... Petrol tank front support rubber ...	2
54	... Gold Star Clubmans ...	65-8201	... Petrol tank badge screw ...	4
55	... Gold Star Clubmans ...	65-8193	... Petrol tank badge ...	2
56	... Gold Star Clubmans ... B31 B32 B33 B34 and ...	65-8200	... Petrol tank badge rubber ring ...	2
57	... Gold Star Clubmans ... B31 B32 B33 B34 and ...	65-8314	... Knee grip (right-hand) ...	1
		65-8315	... Knee grip (left-hand) ...	1
58	... Gold Star Clubmans ... B31 B32 B33 B34 and ...	2-79	... Knee grip plate screw ...	4
59	... Gold Star Clubmans ...	29-7869	... Knee grip plate (right-hand) ...	1
		29-7868	... Knee grip plate (left-hand) ...	1
60	... Gold Star Clubmans ...	36-382	... Petrol tank stiffening plate washer ...	2
61	... Gold Star Clubmans ...	2-923	... Petrol tank stiffening plate washer ...	2
62	... Gold Star Clubmans ...	2-49	... Petrol tank stiffening plate nut ...	2
63	... Gold Star Clubmans ... B31 B32 B33 B34 and ...	67-8085	... Petrol tank stiffening plate ...	1
64	... Gold Star Clubmans ...	27-8443	... Petrol tank filter ...	1
65	... Gold Star Clubmans ...	65-8171	... Petrol tap with washer ...	1
66	... Gold Star Clubmans ... B31 B32 B33 B34 and ...	65-8173	... Petrol pipe ...	2
67	... Gold Star Clubmans ...	65-2353	... Battery carrier swivel block (tapped) ...	1



Plate 16—continued

ACCESSORIES

"B" Group and Gold Star (Clubman's) 350c.c. and 500c.c.

Plate Ref. Number.	Models.	Part No.	Description.	Number per set.
68	B31 B32 B33 B34 and Gold Star Clubmans	65-2352	Battery carrier swivel block (plain hole)	1
69	B31 B32 B33 B34 and Gold Star Clubmans	29-4662	Battery strap bolt saddle washer	1
70	B31 B32 B33 B34 and Gold Star Clubmans	29-4661	Battery carrier strap bolt	1
71	B31 B32 B33 B34 and Gold Star Clubmans	29-4657/3	Battery strap	1
72	B31 B32 B33 B34 and Gold Star Clubmans	29-4665	Battery carrier locating strip	1
73	B31 B32 B33 B34 and Gold Star Clubmans	24-8784	Battery carrier fixing bolt washer (spring)	5
74	B32 B34 and Gold Star Clubmans	2-129	Battery carrier and oil tank fixing bolt	2
75	B31 B33 and Gold Star Clubmans	65-4669	Battery bracket only (when lighting set is not fitted)	1
	B31 B33 and Gold Star Clubmans	65-4668	Battery Bracket	1
76	B31 B32 B33 B34 and Gold Star Clubmans	2-1934	Battery carrier fixing bolt	3
77	B31 B32 B33 B34 and Gold Star Clubmans	29-4664	Battery carrier hinge pin	1
78	B31 B32 B33 B34 and Gold Star Clubmans	24-8504	Petrol filter washer	1
79	B31 B32 B33 B34 and Gold Star Clubmans	2-930	Petrol tap washer	1

Plate 17

ACCESSORIES

"B" Group (Spring Frame) and Gold Star (Clubman's) 350c.c. and 500c.c.

Plate Ref. Number.	Models.	Part No.	Description.	Number per set.
1	B31-2-3-4 Spring	65-8421	Oil return pipe nut washer (fibre)	1
2	B31 B33 Spring	15-447	Front stand mudguard fixing bolt nut	2
3	B31 B33 Spring	65-6608	Front stand complete	1
4	B31-2-3-4 Spring and Gold Star Clubmans	2-49	Support bridge bottom fixing bolt nut	4
5	B31-2-3-4 Spring and Gold Star Clubmans	2-2395	Front mudguard support bridge fixing screw nut	2
6	B31-2-3-4 Spring and Gold Star Clubmans	2-1462	Front mudguard support bridge fixing screw washer (spring)	2
7	B31-2-3-4 Spring and Gold Star Clubmans	66-7518	Front mudguard support bridge fixing screw washer (fibre)	2
8	B31-2-3-4 Spring and Gold Star Clubmans	36-382	Support bridge bottom fixing bolt washer (shakeproof)	4
9	B31 B33 Spring	65-6606	Front mudguard support bridge	1
10	B31-2-3-4 Spring and Gold Star Clubmans	28-2338	Support bridge bottom fixing bolt	4
	B31 B33 Spring	2-1616	Front mudguard stay fork end bolt nut	2
11	B32 B34 Spring and Gold Star Clubmans	2-1616	Front mudguard stay fork end bolt nut	4
	B31 B33 Spring	24-8784	Front mudguard stay fork end bolt washer (spring)	2
12	B32 B34 Spring and Gold Star Clubmans	24-8784	Front mudguard stay fork end bolt washer (spring)	4
13	B31 B33 Spring	65-6607	Front mudguard stay	1
	B31 B33 Spring	15-7354	Front mudguard stay fork end bolt	2
14	B32 B34 Spring and Gold Star Clubmans	15-7354	Front mudguard stay fork end bolt	4
	B31 B33 Spring	2-2395	Front mudguard stay fixing bolt nut	2
15	B32 B34 Spring and Gold Star Clubmans	2-2395	Front mudguard stay fixing bolt nut	4
	B31 B33 Spring	2-1462	Front mudguard stay fixing bolt washer (spring)	2
16	B32 B34 Spring and Gold Star Clubmans	2-1462	Front mudguard stay fixing bolt washer (spring)	4
17	B31-2-3-4 Spring and Gold Star Clubmans	2-2395	Front number plate fixing stud nut	2

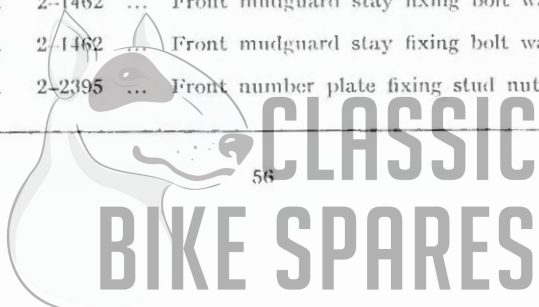

ACCESSORIES

"B" Group (Spring Frame) and Gold Star (Clubman's) 350c.c. and 500c.c.

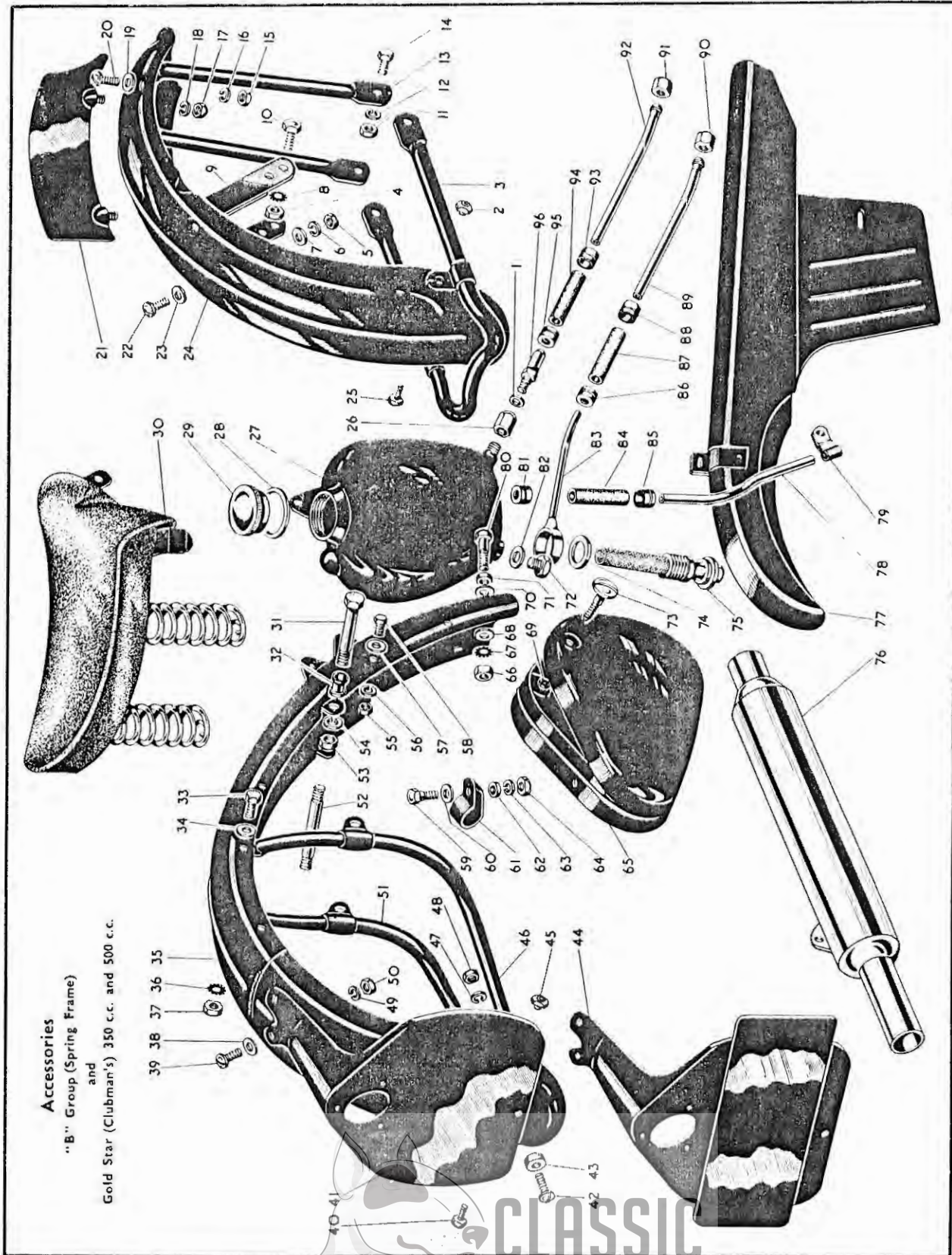

Accessories
"B" Group (Spring Frame)
and
Gold Star (Clubman's) 350 c.c. and 500 c.c.

"B" Group (Spring Frame) and Gold Star (Clubman's) 350c.c. and 500c.c.

Plate Ref. Number.	Models.	Part No.	Description.	Number per set.
18	... Gold Star Clubmans ...	2-1462	Front number plate fixing stud washer (spring)	2
	B31 B33 Spring ...	27-8560	Front mudguard stay fixing bolt washer (plain)	2
	B32 B34 Spring and			
19	... Gold Star Clubmans ...	27-8560	Front mudguard stay fixing bolt washer (plain)	4
	B31 B33 Spring ...	15-7161	Front mudguard stay fixing bolt	2
	B32 B34 Spring and			
20	... Gold Star Clubmans ...	15-7161	Front mudguard stay fixing bolt	4
	B31-2-3-4 Spring and			
21	... Gold Star Clubmans ...	65-6576	Front number plate complete	1
	B31-2-3-4 Spring and			
22	... Gold Star Clubmans ...	15-7161	Front mudguard support bridge fixing screw	2
	B31-2-3-4 Spring and			
23	... Gold Star Clubmans ...	27-8560	Front mudguard support bridge fixing screw washer	2
24	... B31 B33 Spring ...	65-6605	Front mudguard with fixed fittings	1
25	... B31 B33 Spring ...	2-1354	Front stand mudguard fixing bolt	2
26	... B31-2-3-4 Spring ...	65-8424	Oil return pipe nut	1
27	... B31-2-3-4 Spring ...	65-8479	Oil tank with fixed fittings	1
28	... B31-2-3-4 Spring ...	67-42	Oil tank filler cap washer	1
29	... B31-2-3-4 Spring ...	65-8500	Oil tank filler cap	1
30	... B31-2-3-4 Spring ...	66-9202	Saddle	1
31	... B31 B33 Spring ...	67-4030	Mudguard fixing bolt (offside)	1
32	... B31 B33 Spring ...	67-6761	Mudguard fixing bolt and stud spacing washer	3
33	... B31 B33 Spring ...	24-6770	Mudguard support stay bolt	2
34	... B31 B33 Spring ...	2-923	Mudguard support stay bolt washer (plain)	2
35	... B31 B33 Spring ...	65-6862	Rear mudguard with fixed fittings	1
36	... B31 B33 Spring ...	36-382	Mudguard support stay bolt washer (shakeproof)	2
37	... B31 B33 Spring ...	2-49	Mudguard support stay bolt nut	2
38	... B31 B33 Spring ...	27-8560	Rear number plate top fixing screw washer	2
39	... B31 B33 Spring ...	15-7161	Rear number plate top fixing screw	2
40	... B31 B33 Spring ...	2-1354	Rear mudguard stay bolt	2
41	... B31 B33 Spring ...	65-6825	Rear number plate complete	1
42	... B31 B33 Spring ...	1-5945	Rear number plate bottom fixing screw	1
43	... B31 B33 Spring ...	15-7383	Rear number plate washer (rubber) (bottom)	1
44	... B31 B33 Spring ...	65-6826	Rear number plate complete (South Australia)	1
45	... B31 B33 Spring ...	15-447	Rear mudguard stay bolt nut	2
46	... B31 B33 Spring ...	67-6772	Mudguard support complete (offside)	1
47	... B31 B33 Spring ...	2-1462	Rear number plate fixing bolt (bottom) washer (spring)	1
48	... B31 B33 Spring ...	2-2395	Rear number plate fixing bolt (bottom) nut	1
49	... B31 B33 Spring ...	2-1462	Rear number plate fixing screw washer (spring)	2
50	... B31 B33 Spring ...	2-2395	Rear number plate fixing screw nut	2
51	... B31 B33 Spring ...	67-6774	Mudguard support complete (nearside)	1
52	... B31 B33 Spring ...	27-5684	Mudguard fixing stud (seat stay) (nearside)	1
53	... B31 B33 Spring ...	2-449	Mudguard fixing bolt and stud nut	3
54	... B31 B33 Spring ...	2-522	Mudguard fixing bolt and stud washer (spring)	2
55	... B31-2-3-4 Spring ...	2-2395	Toolbox fixing bolt nut	2
56	... B31-2-3-4 Spring ...	2-1462	Toolbox fixing bolt washer (spring)	2
57	... B31-2-3-4 Spring ...	27-8560	Toolbox fixing bolt washer (plain)	2
58	... B31-2-3-4 Spring ...	2-204	Toolbox fixing bolt	2
59	... B31-2-3-4 Spring ...	15-4207	Toolbox fixing clip bolt	1
60	... B31-2-3-4 Spring ...	27-8560	Toolbox fixing clip bolt washer (plain)	1
61	... B31-2-3-4 Spring ...	24-8928	Toolbox fixing clip	1
62	... B31-2-3-4 Spring ...	2-6537	Toolbox fixing clip distance washer	1
63	... B31-2-3-4 Spring ...	2-1462	Toolbox fixing clip bolt washer (spring)	1
64	... B31-2-3-4 Spring ...	2-2395	Toolbox fixing clip bolt nut	1
65	... B31-2-3-4 Spring ...	67-9007	Toolbox complete	1
66	... B31 B33 Spring ...	2-49	Mudguard bottom distance tube bolt nut	1
67	... B31 B33 Spring ...	36-382	Mudguard bottom distance tube bolt washer (shakeproof)	1
68	... B31 B33 Spring ...	36-5344	Mudguard bottom distance tube bolt washer (plain)	1
69	... B31-2-3-4 Spring ...	2-1027	Toolbox lid fixing screw nut	1
70	... B31 B33 Spring ...	36-5344	Mudguard bottom distance tube bolt washer (plain)	1
71	... B31 B33 Spring ...	66-8348	Mudguard bottom distance tube	1
72	... B31-2-3-4 Spring ...	2-84	Oil tank drain plug	1
73	... B31-2-3-4 Spring ...	29-9132	Toolbox lid fixing screw complete	1
74	... B31-2-3-4 Spring ...	29-7971	Oil feed pipe banjo union washer	2
75	... B31-2-3-4 Spring ...	29-7962	Oil tank filter	1
76	... B31-2-3-4 Spring ...	65-2780	Silencer complete	1
77	... B31 B33 Spring ...	65-7720	Rear chainguard complete	1
78	... B31-2-3-4 Spring ...	65-8499	Oil tank breather pipe extension	1
79	... B31-2-3-4 Spring ...	66-8340	Oil tank breather pipe clip	1
80	... B31 B33 Spring ...	65-110	Mudguard bottom distance tube bolt	1
81	... B31-2-3-4 Spring ...	65-8422	Oil tank breather pipe ferrule	1

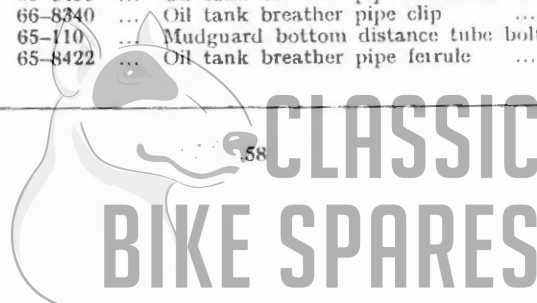

Plate 17—continued

ACCESSORIES

"B" Group (Spring Frame) and Gold Star (Clubman's) 350c.c. and 500c.c.

Plate Ref. Number.	Models.	Part No.	Description.	Number per set.
82	... B31-2-3-4 Spring	... 2-100	... Oil tank drain plug washer	... 1
83	... B31-2-3-4 Spring	... 65-8461	... Oil feed pipe complete (tank)	... 1
84	... B31-2-3-4 Spring	... 65-2060	... Oil tank breather pipe connection	... 1
85	... B31-2-3-4 Spring	... 65-8422	... Oil tank breather pipe ferrule	... 1
86	... B31-2-3-4 Spring	... 65-8422	... Oil feed pipe ferrule	... 1
87	... B31-2-3-4 Spring	... 65-2060	... Oil feed pipe connection	... 1
88	... B31-2-3-4 Spring	... 65-8422	... Oil feed pipe ferrule	... 1
89	... B31-2-3-4 Spring	... 65-8465	... Oil feed and scavenge pipe	... 1
90	... B31-2-3-4 Spring	... 66-8332	... Oil feed and scavenge pipe nipple nut	... 1
91	... B31-2-3-4 Spring	... 66-8332	... Oil return pipe nipple nut	... 1
92	... B31-2-3-4 Spring	... 65-8465	... Oil return pipe	... 1
93	... B31-2-3-4 Spring	... 65-8422	... Oil return pipe ferrule	... 1
94	... B31-2-3-4 Spring	... 65-2060	... Oil return pipe extension	... 1
95	... B31-2-3-4 Spring	... 65-8422	... Oil return pipe ferrule	... 1
96	... B31-2-3-4 Spring	... 65-8420	... Oil return pipe connection	... 1

Plate 18

ACCESSORIES

"B" Group (Spring Frame) and Gold Star (Clubman's) 350c.c. and 500c.c.

Plate Ref. Number.	Models.	Part No.	Description.	Number per set.
1	... Gold Star Clubmans	... 65-8421	... Oil return pipe nut washer (fibre)	... 1
2	... Gold Star Clubmans	... 65-8424	... Oil return pipe nut	... 1
3	... Gold Star Clubmans	... 65-8420	... Oil return pipe connection	... 1
4	... Gold Star Clubmans	... 65-8422	... Oil return pipe ferrule	... 1
5	... Gold Star Clubmans	... 65-8418	... Oil return pipe (rubber)	... 1
6	... Gold Star Clubmans	... 66-8332	... Oil feed pipe nut	... 1
7	... Gold Star Clubmans	... 66-8332	... Oil return pipe nut	... 1
8	... Gold Star Clubmans	... 65-8419	... Oil feed pipe nipple	... 1
9	... Gold Star Clubmans	... 65-8419	... Oil return pipe nipple	... 1
10	... Gold Star Clubmans	... 65-8422	... Oil feed pipe ferrule	... 1
11	... Gold Star Clubmans	... 65-8422	... Oil return pipe ferrule	... 1
12	... Gold Star Clubmans	... 65-8418	... Oil feed pipe (rubber)	... 1
13	... Gold Star Clubmans	... 65-8422	... Oil feed pipe ferrule	... 1
14	... Gold Star Clubmans	... 65-8419	... Oil feed pipe nipple	... 1
15	... Gold Star Clubmans	... 66-8332	... Oil feed pipe nut	... 1
16	... Gold Star Clubmans	... 35-707	... Oil tank filler cap split pin	... 1
17	... Gold Star Clubmans	... 66-8359	... Oil filter element complete	... 1
18	... Gold Star Clubmans	... 65-8526	... Oil tank support bracket	... 1
19	... Gold Star Clubmans	... 24-8784	... Oil tank support bracket bolt washer (spring)	... 2
20	... Gold Star Clubmans	... 15-7354	... Oil tank support bracket bolt	... 2
21	... B32 B34 Spring and Gold Star Clubmans	... 65-6614	... Front mudguard bottom stay	... 1
22	... B32 B34 Spring and Gold Star Clubmans	... 65-6612	... Front mudguard top stay	... 1
23	... B32 B34 Spring and Gold Star Clubmans	... 65-6613	... Front mudguard support bridge	... 1
24	... Gold Star Clubmans	... 65-6611	... Front mudguard with fixed fittings	... 1
25	... B31-2-3-4 Spring	... 65-8317	... Petrol tank badge fixing screw	... 2
26	... B31-2-3-4 Spring	... 65-8157	... Petrol tank badge (nearside)	... 1
27	... B31-2-3-4 Spring	... 65-8158	... Petrol tank badge (offside)	... 1
28	... B31-2-3-4 Spring	... 65-8326	... Petrol tank fixing bolt (front)	... 1
29	... Gold Star Clubmans	... 66-8358	... Oil filter cap (top) complete	... 1
29	... Gold Star Clubmans	... 66-8351	... Oil tank filler cap	... 1
30	... B32 B34 Spring and Gold Star Clubmans	... 15-1355	... Mudguard chainstay bridge bolt	... 1
31	... B32 B34 Spring	... 15-7161	... Chainguard steady bracket screw	... 4
32	... B32 B34 Spring	... 27-8560	... Chainguard steady bracket screw washer (plain)	... 4
33	... B31-2-3-4 Spring	... 65-8150	... Petrol pipe complete	... 1
34	... B31-2-3-4 Spring	... 27-8553	... Petrol tap	... 1
35	... B32 B34 Spring	... 15-7161	... Tool box support bracket fixing screw	... 4
36	... B32 B34 Spring	... 27-8560	... Toolbox support bracket fixing screw washer (plain)	... 4
37	... B32 B34 Spring and Gold Star Clubmans	... 67-6760	... Mudguard to seat stay bolt (offside)	... 1

"B" Group (Spring Frame) and Gold Star (Clubman's) 350c.c. and 500c.c.

Plate Ref. Number.	Models.	Part No.	Description.	Number per set.
38	B32 B34 Spring and Gold Star Clubmans	65-6598	Mudguard distance piece	2
39	B32 B34 Spring	15-7161	Mudguard seat stay bridge fixing screw	2
40	B32 B34 Spring	27-8560	Mudguard seat stay bridge fixing screw washer (plain)	2
41	B32 B34 Spring and Gold Star Clubmans	66-4707	Mudguard to seat stay bolt washer (shakeproof)	2
42	B32 B34 Spring and Gold Star Clubmans	2-46	Mudguard to seat stay bolt nut	2
43	B32 B34 Spring	65-6988	Mudguard seat stay bridge	1
44	B31-2-3-4 Spring	65-8161	Petrol tank	1
45	B31-2-3-4 Spring	66-4707	Petrol tank front fixing bolt washer (shakeproof)	1
46	B31-2-3-4 Spring	2-449	Petrol tank front fixing bolt nut	1
47	B31-2-3-4 Spring	29-7898	Petrol tank filler cap	1
48	B32 B34 Spring and Gold Star Clubmans	27-8560	Rear mudguard stay fixing screw washer (plain)	2
49	B32 B34 Spring and Gold Star Clubmans	15-7161	Rear mudguard stay fixing screw	2
50	B32 B34 Spring and Gold Star Clubmans	65-6859	Rear mudguard stiffening plate (top)	1
51	B32 B34 Spring and Gold Star Clubmans	65-6827	Rear number plate complete	1
52	B32 B34 Spring and Gold Star Clubmans	15-7161	Rear number plate and stay bridge fixing screw	4
53	B32 B34 Spring and Gold Star Clubmans	65-6860	Rear mudguard stiffening plate (bottom)	1
54	B32 B34 Spring and Gold Star Clubmans	65-6976	Rear mudguard with fixed fittings	1
55	B32 B34 Spring and Gold Star Clubmans	1-5945	Rear number plate bottom fixing screw	1
56	B32 B34 Spring and Gold Star Clubmans	27-8560	Rear number plate fixing screw washer (plain)	5
57	B32 B34 Spring and Gold Star Clubmans	15-7383	Rear number plate washer (rubber) (bottom)	1
58	B32 B34 Spring and Gold Star Clubmans	67-6823	Rear mudguard strengthening plate complete	1
59	B32 B34 Spring and Gold Star Clubmans	29-541	Rear number plate fixing screw washer (shakeproof)	5
60	B32 B34 Spring and Gold Star Clubmans	2-2395	Rear number plate fixing screw nut	5
61	B32 B34 Spring and Gold Star Clubmans	2-2395	Bottom stay bolt nut	2
62	B32 B34 Spring and Gold Star Clubmans	29-541	Bottom stay bolt washer (shakeproof)	2
63	B32 B34 Spring and Gold Star Clubmans	65-6983	Mudguard bottom stay (offside)	1
	B32 B34 Spring and Gold Star Clubmans	65-6978	Mudguard bottom stay (nearside)	1
64	B32 B34 Spring and Gold Star Clubmans	2-204	Bottom stay bolt	2
65	B32 B34 Spring and Gold Star Clubmans	65-6989	Mudguard stay bridge	1
66	B32 B34 Spring and Gold Star Clubmans	65-6867	Rear mudguard distance plate	1
67	B32 B34 Spring and Gold Star Clubmans	65-4185	Mudguard to seat stay bolt (nearside)	1
68	B32 B34 Spring and Gold Star Clubmans	65-6932	Rear mudguard stay	1
69	B32 B34 Spring and Gold Star Clubmans	29-541	Rear mudguard stay fixing screw washer (shakeproof)	2
70	B32 B34 Spring and Gold Star Clubmans	2-2395	Rear mudguard stay fixing screw nut	2
71	B32 B34 Spring	2-2395	Mudguard seat stay bridge fixing screw nut	2
72	B32 B34 Spring	29-541	Mudguard seat stay bridge fixing screw washer (shakeproof)	2
73	B32 B34 Spring	2-2395	Toolbox support bracket fixing screw nut	4
74	B32 B34 Spring	29-541	Toolbox support bracket fixing screw washer (shakeproof)	4
75	B32 B34 Spring	65-6987	Toolbox support bracket	1
76	B32 B34 Spring	65-6987	Toolbox support bracket	1
77	B32 B34 Spring and Gold Star Clubmans	65-6598	Mudguard stay spacing tube	2
78	B32 B34 Spring	2-2395	Chainguard steady bracket screw nut	4
79	B32 B34 Spring	29-541	Chainguard steady bracket screw washer (shakeproof)	4
80	B32 B34 Spring	65-6986	Chainguard steady bracket	1

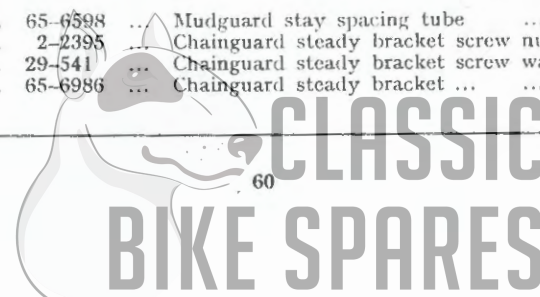

ACCESSORIES

"B" Group (Spring Frame) and Gold Star (Clubman's) 350c.c. and 500c.c.

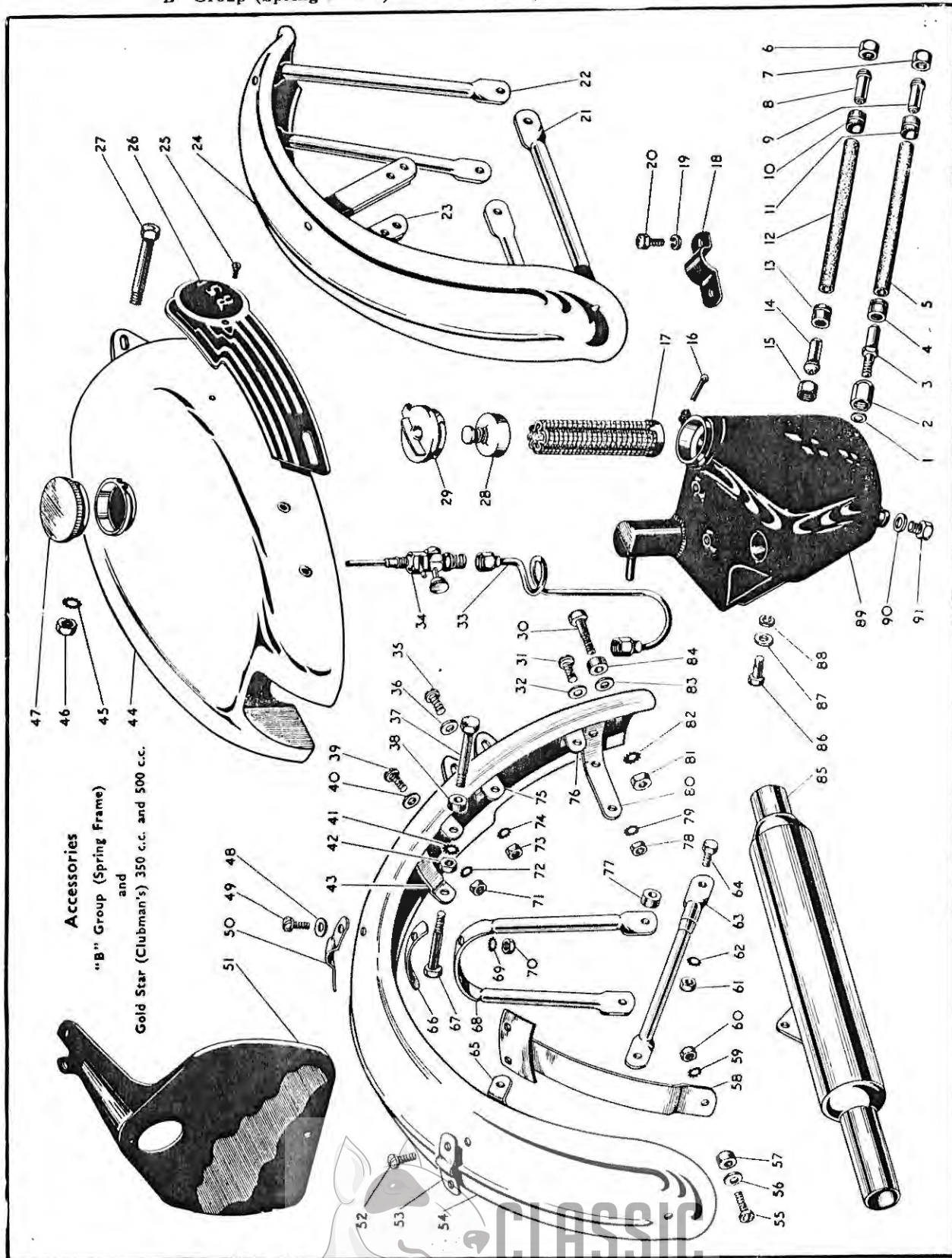

Plate 18—continued

ACCESSORIES

"B" Group (Spring Frame) and Gold Star (Clubman's) 350c.c. and 500c.c.

Plate Ref. Number.	Models.	Part No.	Description.	Number per set.
81	B32 B34 Spring and Gold Star Clubmans ...	2-49	Mudguard chainstay bridge bolt nut	1
82	B32 B34 Spring and Gold Star Clubmans ...	36-382	Mudguard chainstay bridge bolt washer (shakeproof)	1
83	B32 B34 Spring and Gold Star Clubmans ...	36-5344	Mudguard chainstay bridge bolt washer (plain)	1
84	Gold Star Clubmans ...	66-8347	Mudguard chainstay bridge bolt distance tube	1
85	Gold Star Clubmans ...	65-2838	Silencer complete	1
86	Gold Star Clubmans ...	2-1934	Oil tank fixing bolt	4
87	Gold Star Clubmans ...	2-923	Oil tank fixing bolt washer (plain)	4
88	Gold Star Clubmans ...	24-8784	Oil tank fixing bolt washer (spring)	4
89	Gold Star Clubmans ...	65-8530	Oil tank with fixed fittings	1
90	Gold Star Clubmans ...	2-100	Oil tank drain plug washer	1
91	Gold Star Clubmans ...	2-84	Oil tank drain plug	1

Plate 19

REAR MUDGUARD and TOOLBOX FITTINGS

Gold Star (Clubman's) 350c.c. and 500c.c.

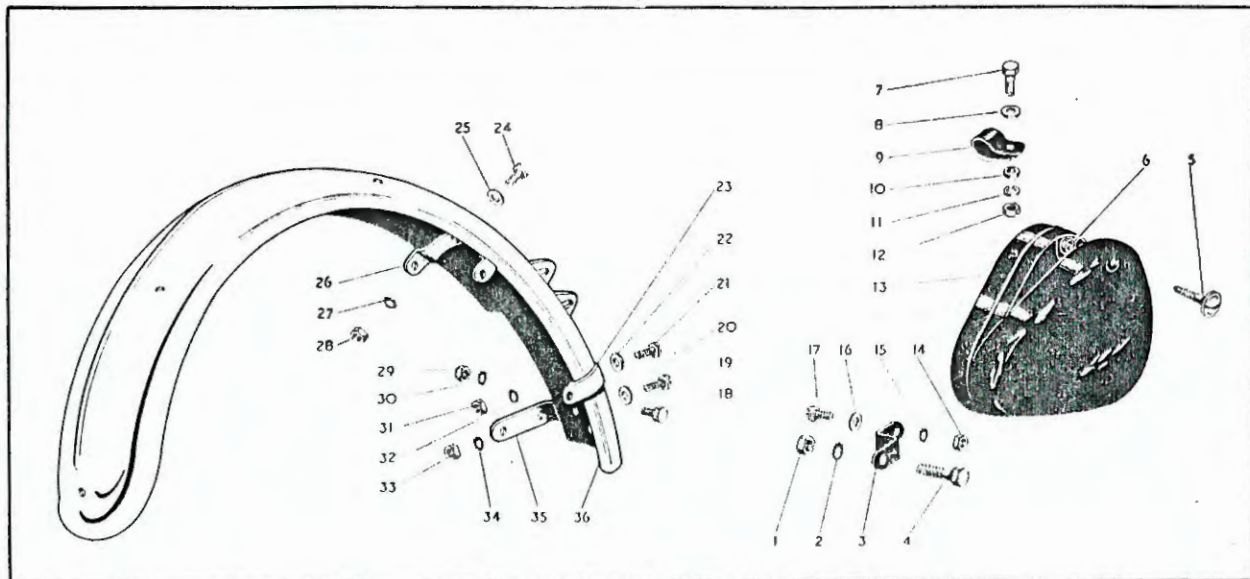

Plate Ref. Number.	Models.	Part No.	Description.	Number per set.
1	Gold Star Clubmans ...	2-449	Toolbox rear bracket fixing bolt nut (rear suspension)	1
2	Gold Star Clubmans ...	66-4707	Toolbox rear bracket fixing bolt washer (shakeproof) (rear suspension)	1
3	Gold Star Clubmans ...	65-9157	Toolbox bracket (rear)	1
4	Gold Star Clubmans ...	2-803	Toolbox rear bracket fixing bolt (rear suspension)	1
5	Gold Star Clubmans ...	29-9132	Toolbox lid fixing screw complete	1
6	Gold Star Clubmans ...	2-1027	Toolbox lid fixing screw nut	1
7	Gold Star Clubmans ...	15-4207	Toolbox fixing clip bolt	1
8	Gold Star Clubmans ...	27-8560	Toolbox fixing clip bolt washer (plain)	1
9	Gold Star Clubmans ...	24-8928	Toolbox fixing clip	1
10	Gold Star Clubmans ...	2-6537	Toolbox fixing clip distance washer	1
11	Gold Star Clubmans ...	2-1462	Toolbox fixing clip washer (spring)	1
12	Gold Star Clubmans ...	2-2395	Toolbox fixing clip bolt	1
13	Gold Star Clubmans ...	65-9019	Toolbox complete	1
14	Gold Star Clubmans ...	2-2395	Toolbox rear bracket fixing bolt nut	1
15	Gold Star Clubmans ...	29-541	Toolbox rear bracket fixing bolt washer (shakeproof)	1
16	Gold Star Clubmans ...	27-8560	Toolbox rear bracket fixing bolt washer (plain)	1
17	Gold Star Clubmans ...	15-7161	Toolbox rear bracket fixing bolt	1
18	Gold Star Clubmans ...	2-204	Toolbox front bracket fixing bolt	1
19	Gold Star Clubmans ...	15-7161	Chainguard steady bracket screw	4
20	Gold Star Clubmans ...	27-8560	Chainguard steady bracket screw washer (plain)	4

Plate 19

REAR MUDGUARD and TOOLBOX FITTINGS

Gold Star (Clubman's) 350c.c. and 500c.c.

Plate Ref. Number	Models.	Part No.	Description.	Number per set.
21	... Gold Star Clubmans ...	15-7161	Toolbox support bracket fixing screw	2
22	... Gold Star Clubmans ...	27-8560	Toolbox support bracket fixing screw washer (plain)	2
23	... Gold Star Clubmans ...	65-6987	Toolbox support bracket	1
24	... Gold Star Clubmans ...	15-7161	Mudguard seatstay bridge fixing screw	2
25	... Gold Star Clubmans ...	27-8560	Mudguard seatstay bridge fixing screw washer (plain)	2
26	... Gold Star Clubmans ...	65-6988	Mudguard seatstay bridge	1
27	... Gold Star Clubmans ...	29-541	Mudguard seatstay bridge fixing screw washer (shakeproof)	2
28	... Gold Star Clubmans ...	2-2395	Mudguard seatstay bridge fixing screw nut	2
29	... Gold Star Clubmans ...	2-2395	Toolbox front bracket fixing bolt nut	1
30	... Gold Star Clubmans ...	29-541	Toolbox front bracket fixing bolt washer (shakeproof)	1
31	... Gold Star Clubmans ...	2-2395	Toolbox support bracket screw nut	2
32	... Gold Star Clubmans ...	29-541	Toolbox support bracket screw washer (shakeproof)	2
33	... Gold Star Clubmans ...	2-2395	Chainguard steady bracket screw nut	4
34	... Gold Star Clubmans ...	29-541	Chainguard steady bracket screw washer (shakeproof)	4
35	... Gold Star Clubmans ...	65-6986	Chainguard steady bracket	1
36	... Gold Star Clubmans ...	65-6976	Rear mudguard with fixed fittings	1

Plate 20

TOOLS and SUNDRIES

"B" Group and Gold Star (Clubman's) 350c.c. and 500c.c.

Plate Ref. Number.	Models.	Part No.	Description.	Number per set.
1	B31 B32 B33 B34 and Gold Star Clubmans	24-8944	Cable clip (Shamrock pattern)	2
2	B31 B32 B33 B34 and Gold Star Clubmans	2-824	Adjustable spanner	1
3	B31 B32 B33 B34 and Gold Star Clubmans	1-3051	Double-ended spanner	1
4	B31 B32 B33 B34 and Gold Star Clubmans	65-9246	Combined spanner	1
5	B31 B32 B33 B34 and Gold Star Clubmans	65-9132	Tappet spanner	1
6	B31 B32 B33 B34 and Gold Star Clubmans	29-9254	Rear hub spanner	1
7	B31 B32 B33 B34 and Gold Star Clubmans	65-9170	Pillion seat	1
8	B31 B32 B33 B34 and Gold Star Clubmans	65-9240	Valve grinding tool complete	1
9	B31 B32 B33 B34 and Gold Star Clubmans	27-8958	Inflator	1
10	B31 B32 B33 B34 and Gold Star Clubmans	65-9243	Combined spanner	1
11	B31 B32 B33 B34 and Gold Star Clubmans	29-9255	Front hub spanner	1
12	B31 B32 B33 B34 and Gold Star Clubmans	29-9253	Tommy bar	1
13	B31 B32 B33 B34 and Gold Star Clubmans	15-832	Box spanner (small)	1
14	B31 B32 B33 B34 and Gold Star Clubmans	65-9133	Tappet adjusting spanner	1
15	B31-2-3-4 Spring and Gold Star Clubmans	65-9130	Tappet feelers	1
18	B31 B32 B33 B34 and Gold Star Clubmans	65-9115	Box spanner	1
19	B31 B32 B33 B34 and Gold Star Clubmans	29-9251	Magdyno spanner	1
20	B31 B32 B33 B34 and Gold Star Clubmans	66-9049	Cable clip (rubber)	4
21	B31 B32 B33 B34 and Gold Star Clubmans	66-9132	Sparking plug spanner and screwdriver	1
22	B31 B32 B33 B34 and Gold Star Clubmans	15-7161	Pillion seat bolt	4
23	B31 B32 B33 B34 and Gold Star Clubmans	2-1462	Pillion seat bolt washer (spring)	4
24	B31 B32 B33 B34 and Gold Star Clubmans	2-2395	Pillion seat bolt nut	4
25	B31 B32 B33 B34 and Gold Star Clubmans	29-9252	Tyre lever	1
26	B31 B32 B33 B34 and Gold Star Clubmans	28-4265	Grease gun	1
27	B31 B32 B33 B34 and Gold Star Clubmans	90-9024	Tail lamp wire clip (rubber)	4
		65-9245	Double-ended box spanner (rear wheel spindle and nut)	1

Rear Mudguard
Toolbox
and Sundries



TOOLS and SUNDRIES

"B" Group and Gold Star (Clubman's) 350c.c. and 500c.c.

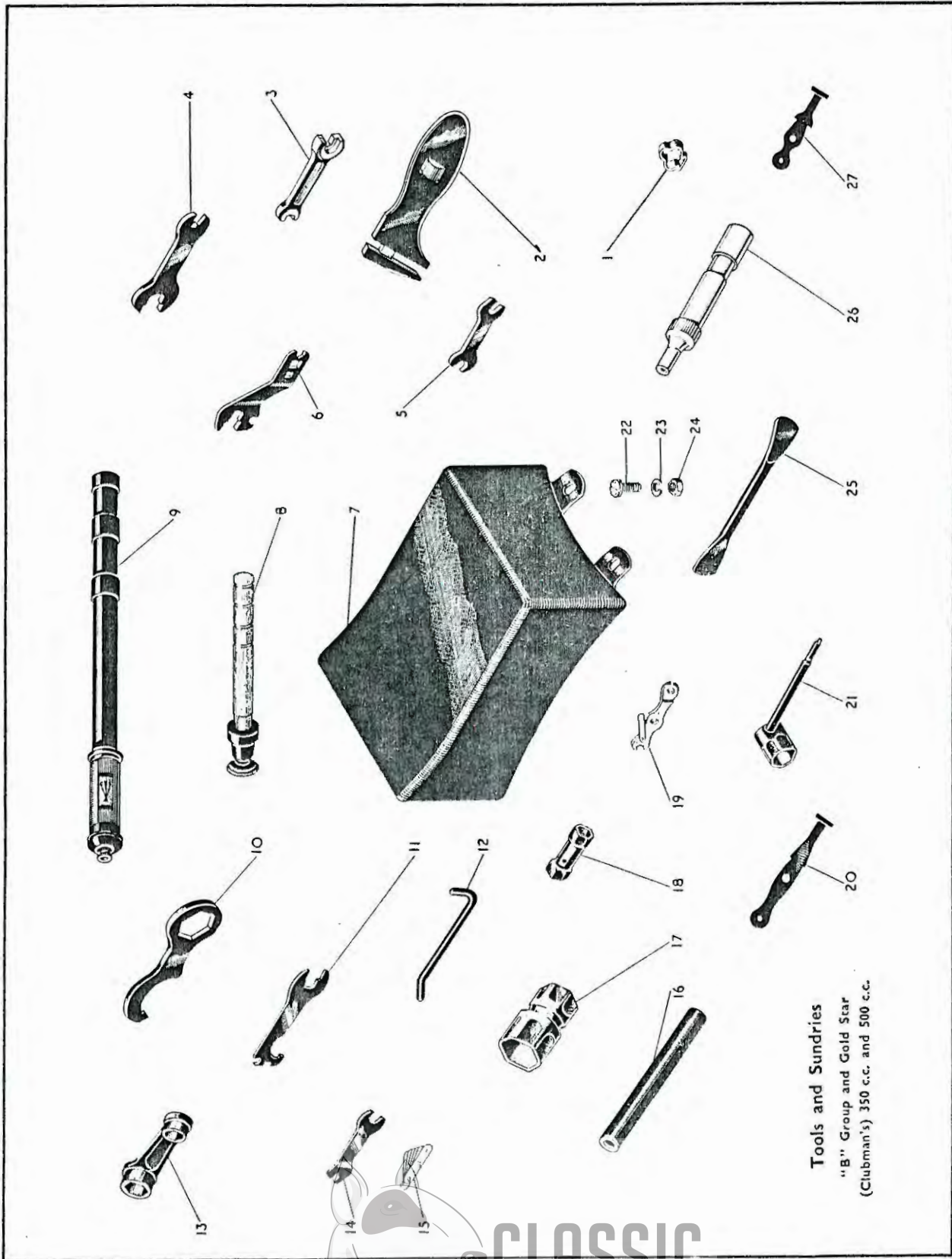

Tools and Sundries
"B" Group and Gold Star
(Clubman's) 350 c.c. and 500 c.c.

LEGSHIELDS B31-33

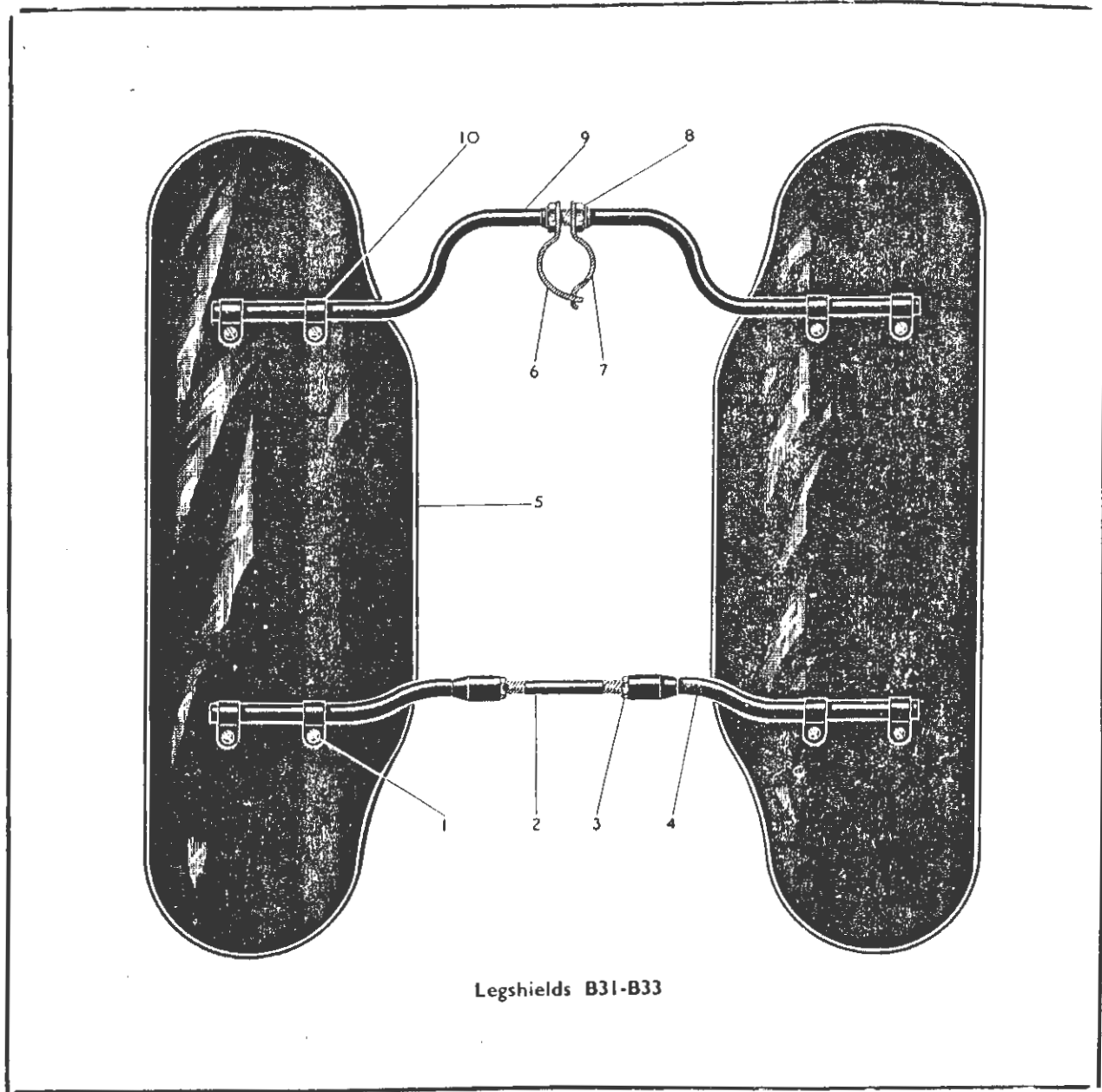

Legshields B31-B33

Plate Ref. Number.	Models.	Part No.	Description.	Number per set.
1	B31 B33	15-7161	Legshield clip support screw	8
	B31 B33	2-2395	Legshield clip support screw nut	8
	B31 B33	27-8560	Legshield clip support bolt washer	8
2	B31 B33	66-7372	Engine plate and crankcase stud	1
3	B31 B33	3-720	Engine plate and crankcase stud locknut	2
4	B31 B33	66-7370	Legshield support tube (bottom)	2
5	B31 B33	66-7367	Legshield only	2
6	B31 B33	65-7286	Legshield support frame clip (right-hand)	1
7	B31 B33	65-7287	Legshield support frame clip (left-hand)	1
8	B31 B33	27-7979	Legshield support tube sleeve nut	2
9	B31 B33	66-7368	Legshield top support tube	1
10	B31 B33	66-7353	Legshield support tube clip	8

Legshields

Plate 22

ELECTRICAL EQUIPMENT

"B" Group and Gold Star (Clubman's) 350c.c. and 500c.c.

Plate Ref. Number.	Models.	Part No.	Description.	Number per set.
1	B31 B32 B33 B34	3-1399	Stop light plate bolt	1
2	B31 B32 B33 B34	19-1106	Stop lamp switch (Lucas)	1
3	B31 B32 B33 B34	29-9342	Stop lamp plate	1
4	B31 B32 B33 B34	2-1309	Switch screw	2
5	B31 B32 B33 B34	2-861	Stop lamp plate washer	1
6	B31 B32 B33 B34	2-449	Plate bolt nut...	1
7	B31 B32 B33 B34	29-3319	Switch screw washer	2
8	B31 B32 B33 B34	2-47	Switch screw nut	2
9	B31 B32 B33 B34	29-3319	Clip screw washer	1
10	B31 B32 B33 B34	2-1588	Clip screw nut	1
11	B31 B32 B33 B34	65-9231	Switch operating spring	1
12	B31 B32 B33 B34	65-9228	Spring clip	1
13	B31 B32 B33 B34	65-5912	Spring clip screw	1
14	B31 B32 B33 B34 and Gold Star Clubmans	19-1201	Magdyno (Lucas)	1
15	B31 B32 B33 B34 and Gold Star Clubmans	65-9160	Speedometer cable	1
16	B31 B32 B33 B34 and Gold Star Clubmans	2-204	Speedometer bracket bolt	2
17	B31 B32 B33 B34 and Gold Star Clubmans	2-1462	Speedometer mounting bolt washer	2
18	B31 B32 B33 B34 and Gold Star Clubmans	65-9111	Speedometer bracket	1
19	B31 B32 B33 B34 and Gold Star Clubmans	19-2110	Speedometer	1
20	B31-2-3-4 Spring and Gold Star Clubmans	19-2004	Electric horn	1
21	B31 B32 B33 B34 and Rigid Frame	19-2002	Electric horn	1
22	B31 B32 B33 B34 and Gold Star Clubmans	2-2395	Voltage control nut	2
23	B31 B32 B33 B34 and Gold Star Clubmans	15-7383	Voltage control support washer (rubber)	2
24	B31 B32 B33 B34 and Gold Star Clubmans	24-8784	Voltage control washer	4
25	B31 B32 B33 B34 and Gold Star Clubmans	2-443	Voltage control locknut	2
26	B31 B32 B33 B34 and Gold Star Clubmans	27-8560	Voltage control support washer	6
27	B31 B32 B33 B34 and Gold Star Clubmans	2-14	Voltage control support bolt	2
28	B31 B32 B33 B34 and Gold Star Clubmans	19-1515	Regulator	1
29	B31 B32 B33 B34 and Gold Star Clubmans	65-5912	Tail lamp fixing screw	3
30	B31 B32 B33 B34 and Gold Star Clubmans	29-545	Tail lamp earthing washer	1
31	B31 B32 B33 B34 and Gold Star Clubmans	2-1588	Tail lamp fixing screw nut	3
32	B31 B32 B33 B34 and Gold Star Clubmans	19-1001	Tail lamp (Lucas)	1
33	B31 B32 B33 B34 and Gold Star Clubmans	19-2012	Horn push	1
34	B31 B32 B33 B34 and Gold Star Clubmans	19-509	Head lamp	1
35	B31 B32 B33 B34 and Gold Star Clubmans	29-9221	Licence holder...	1
*36	B31 B32 B33 B34	19-1004	Stop lamp (Lucas)	1

*Fitted on and after Frame Number ZB31-19001.



Plate 22.

ELECTRICAL EQUIPMENT

"B" Group and Gold Star (Clubman's) 350c.c. and 500c.c.

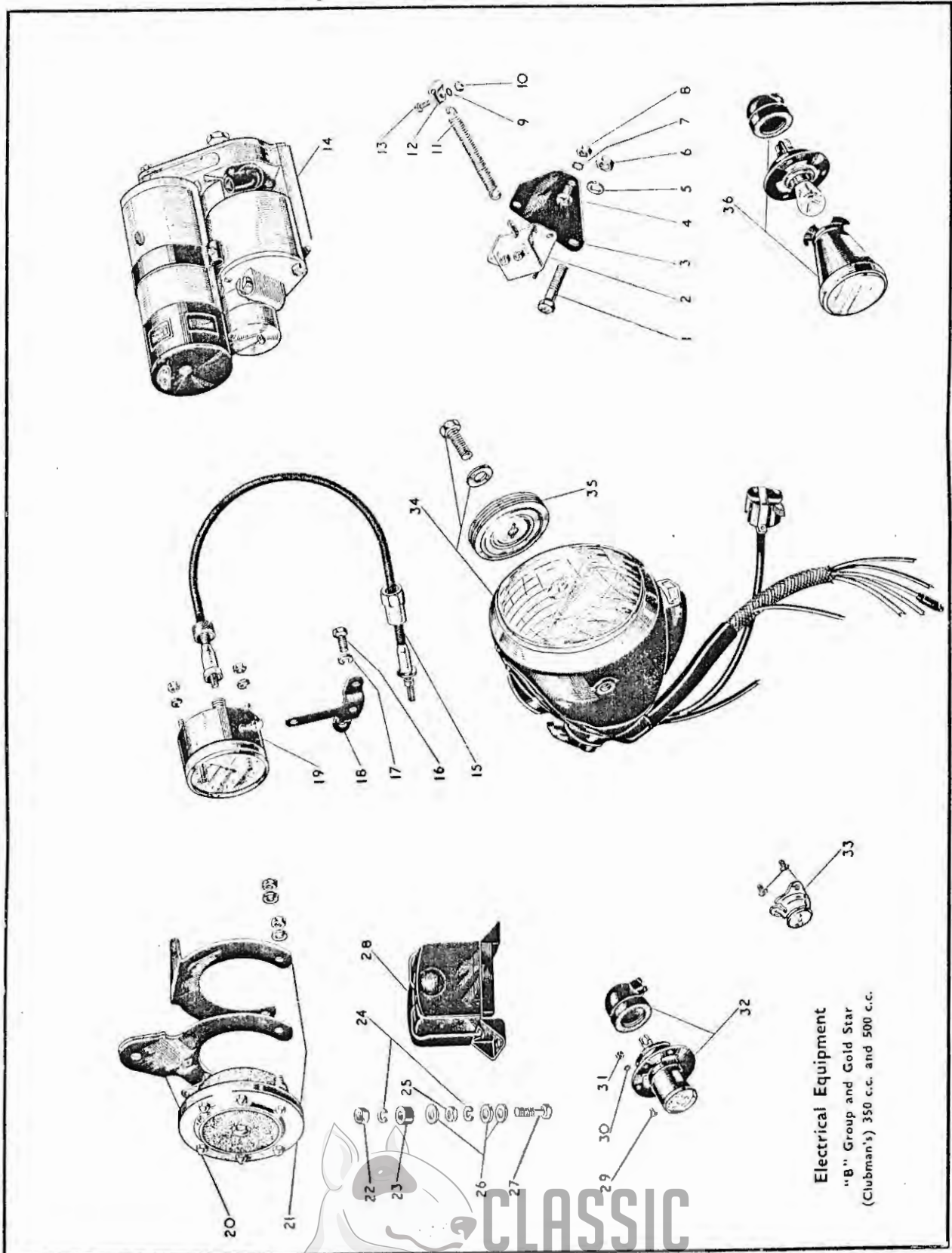

Electrical Equipment
"B" Group and Gold Star
(Clubman's) 350 c.c. and 500 c.c.

NEW COMPONENTS FOR "B" GROUP, 1953

ENGINE—Models B31, B33.

As 1952 except the following:

Models.	Part No.	Description.	Number per set.
B33	65-1707	Cylinder barrel	1
B31	65-1703	Cylinder barrel	1
B33	65-1704	Cylinder head complete	1
B31	65-1700	Cylinder head complete	1
B33	65-1692	Piston complete (6.5 to 1 CR)	1
B33	65-1660	Piston complete (7.5 to 1 CR)	1
B31	65-809	Piston complete (6.5 to 1 CR)	1
B33	65-1613	Connecting rod complete with bushes	1
B33	65-1740	Flywheel with engine shaft (drive side)	1
B33	65-1742	Flywheel with engine shaft (gear side)	1
B31 B33	65-2890	Exhaust pipe finned collar	1
B31 B33	21-6187	Exhaust pipe finned collar screw	1
B31 B33	21-5102	Exhaust pipe finned collar nut	1
B31 B33	29-541	Exhaust pipe finned collar washer (shakeproof)	1

FRONT FORK (1953) MODELS B31 B33.

As 1952 except the following:

Models.	Part No.	Description.	Number per set.
B31	65-5432	Front fork assembled	1
B33	65-5433	Front fork assembled	1
B31 B33	65-5430	Front fork top yoke	1
B31 B33	67-5009	Front fork outer sleeve	2
B31 B33	65-5435	Front fork bottom yoke bolt	2
B33	67-5057	Front fork sliding tube (nearside)	1

FRONT HUB AND WHEEL FITTINGS (1953).

Model B33 (8" Brake).

As 1952 Gold Star except the following:

Part No.	Description.	Number per set.
67-5543	Front wheel rim	1
67-5544	Front wheel spoke (short)	20
67-5545	Front wheel spoke (long)	20
67-5542	Front wheel complete (less brake and tyre)	1

FRONT MUDGUARDS AND FITTINGS (1953).

Model B33 as 1952 except the following:

Part No.	Description.	Number per set.
67-6543	Front mudguard with fixed fittings	1
67-6544	Front mudguard stay	1
28-2338	Support bridge bottom fixing bolt	2
67-6546	Support bridge insulator (rubber)	2
67-6547	Mudguard stay insulator (rubber)	2
67-6530	Front stand complete	1



(B GROUP 1953—contd.)

REAR MUDGUARDS AND FITTINGS (1953).
Models B31, B33 as 1952 except the following:

Part No.	Description.	Number per set.
65-8742	Rear mudguard with fixed fittings (rigid frame)	1
65-8740	Rear mudguard with fixed fittings (spring frame)	1
67-6839	Rear mudguard tail lamp wiring grommet	2
67-6830	Rear number plate complete	1
2-220	Rear number plate fixing bolt	4
29-541	Rear number plate fixing bolt washer	4
67-6851	Rear number plate rubber extrusion	1
67-9067	Rear reflector	1

PETROL TANK AND FITTINGS (1953).
Models "B" Group.

As 1952 except the following:

Part No.	Description.	Number per set.
65-8215	Petrol tank	1
65-8207	Petrol tank badge with centre (offside)	1
65-8208	Petrol tank badge (less centre) (offside)	1
65-8209	Petrol tank badge with centre (nearside)	1
65-8210	Petrol tank badge (less centre) (nearside)	1
65-8211	Petrol tank badge centre	2
65-8217	Petrol tank badge washer	2
67-8109	Petrol tank front mounting tube	2
65-8202	Petrol tank front mounting rubber	2
65-8153	Flexible petrol pipe (B32, B34 only)	1

TOOLBOX AND REAR BRAKE PEDAL STOP (1953).

Models "B" Group.

As 1952 except the following:

Part No.	Description.	Number per set.
67-9002	Toolbox complete	1
2-204	Toolbox fixing clip bolt	1
65-7080	Rear brake pedal stop	1

ELECTRICAL EQUIPMENT (1953).

Models B31, B33.

As 1952 except the following:

Models.	Part No.	Description.	Number per set.
B31 B33	19-511/37	Headlamp (cowl fitting)	1
B31 B33	19-660	Headlamp harness	1
B31 B33	67-5084	Headlamp cowl	1
B31 B33	67-5090	Headlamp cowl blanking washer (when speedo is not fitted)	1
B31 B33	19-1000	Stop and tail light	1
B31 B33	19-1106	Stop lamp switch	1
B31 B33	67-5087	Headlamp cowl rubber extrusion	1

SPEEDOMETERS (COWL FITTING) (1953).

Models B31, B33.

Models.	Part No.	Description.	Number per set.
B31	12-2103	Speedometer	1
B33	19-2109	Speedometer	1
B31 B33	67-5088	Speedometer mounting rubber	1
B31 B33	29-9326	Speedometer cable	1
B31 B33	19-2126	Speedometer cable rubber grommet	1

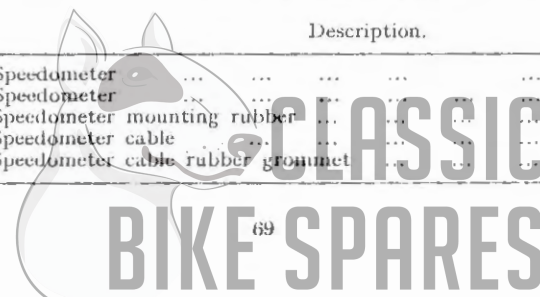

CLASSIC
BIKE SPARES

Component
for 1953

ENGINE

350c.c. and 500c.c. Gold Star (Clubmans and Road Racing) (Swinging Arm).

As 1952 Clubmans except the following:

(These items are not illustrated)

Models.	Part No.	Description.	Number per set.
350c.c. ...	42-25	Carburetter and cylinder head packing piece	1
500c.c. ...	42-24	Carburetter and cylinder head packing piece	1
350c.c. ...	42-23	Carburetter securing stud...	2
500c.c. ...	42-22	Carburetter securing stud...	2
350c.c. ...	65-1232	Carburetter joint washer (paper)	2
500c.c. ...	65-1417	Carburetter joint washer (paper)	2
350c.c. 500c.c. ...	2-49	Carburetter stud nut	2
350c.c. 500c.c. ...	36-382	Carburetter stud nut washer (shakeproof)	2
350c.c. 500c.c. ...	42-42	Cush drive distance piece	1
350c.c. 500c.c. ...	67-66	Exhaust lifter plug screw (Road Racing only)	1
350c.c. 500c.c. ...	2-2894	Exhaust lifter plug washer (Road Racing only)	1
500c.c. ...	65-2444	Camwheel complete (inlet)	1
500c.c. ...	65-2446	Camwheel complete (exhaust)	1
500c.c. ...	65-696	Engine shaft timing pinion	1
500c.c. ...	65-1435	Timing cover complete	1
350c.c. 500c.c. ...	65-1437	Rev counter driving member	1
350c.c. 500c.c. ...	65-9174	Speedo and rev counter mounting bracket (required when rev counter and speedo is fitted).	1
350c.c. 500c.c. ...	2-204	Speedo and rev counter mounting bracket screw (required when rev counter and speedo is fitted).	2
350c.c. 500c.c. ...	2-1462	Speedo and rev counter mounting bracket washer (required when rev counter and speedo is fitted).	2
350c.c. 500c.c. ...	65-9164	Rev counter gearbox	1
350c.c. 500c.c. ...	65-9165	Rev counter gearbox fixing bolt	2
350c.c. 500c.c. ...	65-9166	Rev counter head	1
350c.c. 500c.c. ...	65-9167	Rev counter fixing bracket complete (required when rev counter only is fitted)	1
350c.c. 500c.c. ...	15-7383	Rev counter support bracket rubber (required when rev counter only is fitted)	4
350c.c. 500c.c. ...	27-8560	Rev counter support bracket washer (plain) (required when rev counter only is fitted).	8
350c.c. 500c.c. ...	65-9179	Rev counter bracket fixing bolt...	2
350c.c. 500c.c. ...	65-9172	Rev counter cable	1
350c.c. ...	19-2319	Carburetter	1
500c.c. ...	19-2318	Carburetter	1
350c.c. 500c.c. ...	42-46	Rocker oil feed pipe complete	1
350c.c. 500c.c. ...	65-318	Rocker oil feed pipe banjo screw (exhaust)	1
The following components as fitted to 350c.c. and 500c.c. Gold Star 1952 will not be required for 1953 Road Racing model.			
350c.c. 500c.c. ...	65-387	Exhaust lifter bush	1
350c.c. 500c.c. ...	2-2894	Exhaust lifter bush washer (fibre)	1
350c.c. 500c.c. ...	65-1165	Exhaust lifter spindle	1
350c.c. 500c.c. ...	65-1137	Exhaust lifter	1
350c.c. 500c.c. ...	2-525	Exhaust lifter spindle washer	2
350c.c. 500c.c. ...	2-443	Exhaust lifter spindle nut	2
350c.c. 500c.c. ...	35-701	Exhaust lifter split pin	1
350c.c. 500c.c. ...	65-401	Exhaust lifter spindle washer (felt)	1
350c.c. 500c.c. ...	65-402	Exhaust lifter spindle washer	1
350c.c. 500c.c. ...	65-403	Exhaust lifter spindle spring	1
350c.c. 500c.c. ...	66-1431	Exhaust lifter lever	1
350c.c. 500c.c. ...	27-1163	Exhaust lifter cable holder	1
350c.c. 500c.c. ...	2-443	Exhaust lifter cable holder nut	1

ENGINE

350c.c. and 500c.c. Gold Star (Scrambles) (Swinging Arm).

As 1952 Clubmans except the following:

Models.	Part No.	Description.	Number per set.
500c.c. ...	65-1749	Cylinder head complete	1
500c.c. ...	65-1752	Valve (inlet)	1
500c.c. ...	65-1753	Valve (exhaust)	1
350c.c. ...	65-1612	Valve (exhaust)	1
350c.c. ...	19-2320	Carburetter	1
500c.c. ...	19-2316	Carburetter	1
350c.c. ...	65-1673	Piston complete with rings, gudgeon pin and circlips	1
500c.c. ...	65-1537	Piston complete with rings, gudgeon pin and circlips	1
350c.c. 500c.c. ...	65-2454	Camwheel complete (inlet)	1
350c.c. 500c.c. ...	65-2450	Camwheel complete (exhaust)	1



ENGINE—continued.

350c.c and 500c.c. Gold Star (Scrambles) (Swinging Arm)

As 1952 Clubmans except the following

(These items are not illustrated)

Models.	Part No.	Description.	Number per set.
350c.c. ...	65-692	Engine shaft timing pinion	1
500c.c. ...	42-42	Cush drive distance piece	1
350c.c. ...	65-1606	Cylinder head gasket	1
350c.c. ...	65-2143	Timing cover complete	1
350c.c. ...	19-1204	Magneto	1
350c.c. ...	65-1423	Magneto strap (long) complete	1
350c.c. 500c.c. ...	42-46	Rocker oil feed pipe complete	1
350c.c. 500c.c. ...	65-318	Rocker oil feed pipe banjo screw (exhaust)	1
350c.c. 500c.c. ...	65-1437	Rev counter driving member	1
350c.c. 500c.c. ...	65-9174	Speedo and rev counter mounting bracket (required when rev counter and speedo is fitted).	1
350c.c. 500c.c. ...	2-204	Speedo and rev counter mounting bracket screw (required when rev counter and speedo is fitted).	2
350c.c. 500c.c. ...	2-1462	Speedo and rev counter mounting bracket washer (required when rev counter and speedo is fitted).	2
350c.c. 500c.c. ...	65-9164	Rev counter gearbox	1
350c.c. 500c.c. ...	65-9165	Rev counter gearbox fixing bolt	2
350c.c. 500c.c. ...	65-9166	Rev counter head	1
350c.c. 500c.c. ...	65-9167	Rev counter fixing bracket complete (required when rev counter only is fitted)	1
350c.c. 500c.c. ...	15-7383	Rev counter support bracket rubber (required when rev counter only is fitted)	4
350c.c. 500c.c. ...	27-8560	Rev counter support bracket washer (plain) (required when rev counter only is fitted).	8
350c.c. 500c.c. ...	65-9179	Rev counter bracket fixing bolt...	2
350c.c. 500c.c. ...	65-9172	Rev counter cable	1

Models 350c.c. and 500c.c. Gold Star (Trials) (Swinging Arm) as 1952 Clubmans except the following:

350c.c. ...	65-1756	Cylinder head complete	1
500c.c. ...	65-1749	Cylinder head complete	1
350c.c. ...	65-1759	Valve (inlet)	1
500c.c. ...	65-1752	Valve (inlet)	1
350c.c. ...	65-1760	Valve (exhaust)	1
500c.c. ...	65-1753	Valve (exhaust)	1
350c.c. ...	19-2314	Carburetter	1
500c.c. ...	19-2303	Carburetter	1
350c.c. 500c.c. ...	65-2420	Camwheel complete (inlet and exhaust)	2
350c.c. ...	65-1680	Piston complete with rings, gudgeon pin and circlips	1
500c.c. ...	65-1244	Piston complete with rings, gudgeon pin and circlips	1
350c.c. ...	65-1163	Carburetter flange joint washer	1
350c.c. ...	15-1568	Engine sprocket (16T)	1
350c.c. ...	65-2430	Engine sprocket (15T)	1
350c.c. ...	65-2431	Cush drive sliding sleeve (for use with 65-2430 sprocket)	1
350c.c. ...	65-1606	Cylinder head gasket	1
350c.c. 500c.c. ...	65-1423	Magneto strap (long) complete	1
350c.c. ...	65-2143	Timing cover complete	1
350c.c. ...	65-1147	Valve spring (outer)	2
350c.c. 500c.c. ...	42-46	Rocker oil feed pipe complete	1
350c.c. 500c.c. ...	65-318	Rocker oil feed pipe banjo screw (exhaust)	1
350c.c. 500c.c. ...	65-1437	Rev counter driving member	1
350c.c. 500c.c. ...	65-9174	Speedo and rev counter mounting bracket (required when rev counter and speedo is fitted).	1
350c.c. 500c.c. ...	2-204	Speedo and rev counter mounting bracket screw (required when rev counter and speedo is fitted).	2
350c.c. 500c.c. ...	2-1462	Speedo and rev counter mounting bracket washer (required when rev counter and speedo is fitted).	2
350c.c. 500c.c. ...	65-9164	Rev counter gearbox	1
350c.c. 500c.c. ...	65-9165	Rev counter gearbox fixing bolt	2
350c.c. 500c.c. ...	65-9166	Rev counter head	1
350c.c. 500c.c. ...	65-9167	Rev counter fixing bracket complete (required when rev counter only is fitted)...	1
350c.c. 500c.c. ...	15-7383	Rev counter support bracket rubber (required when rev counter only is fitted)...	4
350c.c. 500c.c. ...	27-8560	Rev counter support bracket washer (plain) (required when rev counter only is fitted).	8
350c.c. 500c.c. ...	65-9179	Rev counter bracket fixing bolt...	2
350c.c. 500c.c. ...	65-9172	Rev counter cable	1

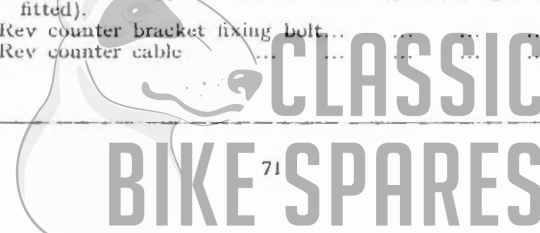

ENGINE—continued.

350c.c. and 500c.c. Gold Star (Touring or Road Trim) (Swinging Arm).

As 1952 Gold Star Clubmans except the following:

(These items are not illustrated)

Models.	Part No.	Description.	Number per set.
350c.c. ...	19-2320	Carburetter ...	1
500c.c. ...	19-2316	Carburetter ...	1
350c.c. 500c.c. ...	65-2448	Camwheel complete (inlet) ...	1
350c.c. 500c.c. ...	65-2450	Camwheel complete (exhaust) ...	1
350c.c. 500c.c. ...	65-692	Engine shaft timing pinion ...	1
350c.c. ...	65-1606	Cylinder head gasket ...	1
350c.c. ...	65-1653	Cylinder base shim ...	1
350c.c. 500c.c. ...	42-46	Rocker oil feed pipe complete ...	1
350c.c. 500c.c. ...	65-318	Rocker oil feed pipe banjo screw (exhaust) ...	1
350c.c. 500c.c. ...	65-1437	Rev counter driving member ...	1
350c.c. 500c.c. ...	65-9174	Speedo and rev counter mounting bracket (required when rev counter and speedo is fitted).	1
350c.c. 500c.c. ...	2-204	Speedo and rev counter mounting bracket screw (required when rev counter and speedo is fitted).	2
350c.c. 500c.c. ...	2-1462	Speedo and rev counter mounting bracket washer (required when rev counter and speedo is fitted).	2
350c.c. 500c.c. ...	65-9164	Rev counter gearbox ...	1
350c.c. 500c.c. ...	65-9165	Rev counter gearbox fixing bolt ...	2
350c.c. 500c.c. ...	65-9166	Rev counter head ...	1
350c.c. 500c.c. ...	65-9167	Rev counter fixing bracket complete (required when rev counter only is fitted)...	1
350c.c. 500c.c. ...	15-7383	Rev counter support bracket rubber (required when rev counter only is fitted)...	4
350c.c. 500c.c. ...	27-8560	Rev counter support bracket washer (plain) (required when rev counter only is fitted).	8
350c.c. 500c.c. ...	65-9179	Rev counter bracket fixing bolt...	2
350c.c. 500c.c. ...	65-9172	Rev counter cable ...	1

Plate 23

GEARBOX

350c.c. and 500c.c. Gold Star (Swinging Arm)

Plate Ref. Number.	Models.	Part No.	Description.	Number per set.
1 ...	350c.c. 500c.c.	67-3026	Ball bearing spring ring ...	1
2 ...	350c.c. 500c.c.	67-3067	Gearbox sprocket oil seal ...	1
3 ...	350c.c. 500c.c.	24-4065	Constant mesh gear ball bearing ...	1
4 ...	350c.c. 500c.c.	67-3073	Constant mesh gear bush ...	1
— ...	350c.c. 500c.c.	67-3073	Constant mesh gear bush (Clubmans and Road Racing) (extra close).	1
5 ...	350c.c. 500c.c.	67-3192	Constant mesh gear complete (26T) ...	1
— ...	350c.c. 500c.c.	67-3309	Constant mesh gear complete (26T) (Trials) ...	1
— ...	350c.c. 500c.c.	67-3311	Constant mesh gear complete (25T) (Scrambles) ...	1
— ...	350c.c. 500c.c.	67-3184	Constant mesh gear complete (25T) (Clubmans and Road Racing) (extra close).	1
6 ...	350c.c. 500c.c.	67-3080	Constant mesh gear bush (drilled) ...	1
7 ...	350c.c. 500c.c.	67-3201	Mainshaft sliding gear (20T) ...	1
— ...	350c.c. 500c.c.	67-3361	Mainshaft sliding gear (22T) (Clubmans and Road Racing) (extra close).	1
— ...	350c.c. 500c.c.	67-3301	Mainshaft sliding gear (17T) (Trials) ...	1
— ...	350c.c. 500c.c.	67-3302	Mainshaft sliding gear (19T) (Scrambles) ...	1
— ...	350c.c. 500c.c.	67-3187	Mainshaft sliding gear (24T) (Clubmans and Road Racing) (extra close)	1
— ...	350c.c. 500c.c.	67-3210	Mainshaft sliding gear (22T) (Trials) ...	1
— ...	350c.c. 500c.c.	67-3305	Mainshaft sliding gear (22T) (Scrambles) ...	1
8 ...	350c.c. 500c.c.	67-3202	Mainshaft sliding gear (24T) ...	1
9 ...	350c.c. 500c.c.	67-3329	Gearbox mainshaft complete with gear (Standard) ...	1
— ...	350c.c. 500c.c.	67-3330	Gearbox mainshaft only (Standard) ...	1
— ...	350c.c. 500c.c.	67-3314	Gearbox mainshaft complete with gear (Scrambles) ...	1
— ...	350c.c. 500c.c.	67-3322	Gearbox mainshaft complete with gear (Clubmans and Road Racing) (extra close).	1
— ...	350c.c. 500c.c.	67-3313	Gearbox mainshaft only (Trials) ...	1
— ...	350c.c. 500c.c.	67-3315	Gearbox mainshaft only (Scrambles) ...	1
— ...	350c.c. 500c.c.	67-3330	Gearbox mainshaft only (Clubmans and Road Racing) (extra close).	1
10 ...	350c.c. 500c.c.	2-433	Gearbox mainshaft key ...	1
11 ...	350c.c. 500c.c.	29-3860	Clutch push rod ...	1
12 ...	350c.c. 500c.c.	67-3101	Mainshaft gear locating ring ...	1
13 ...	350c.c. 500c.c.	67-3191	Gearbox mainshaft gear (16T) ...	1
— ...	350c.c. 500c.c.	67-3191	Gearbox mainshaft gear (16T) (Scrambles) ...	1
— ...	350c.c. 500c.c.	67-3221	Gearbox mainshaft gear (18T) (Clubmans and Road Racing) (extra close).	1
14 ...	350c.c. 500c.c.	24-4217	Mainshaft bearing ...	1



GEARBOX

350c.c. and 500c.c. Gold Star (Swinging Arm)

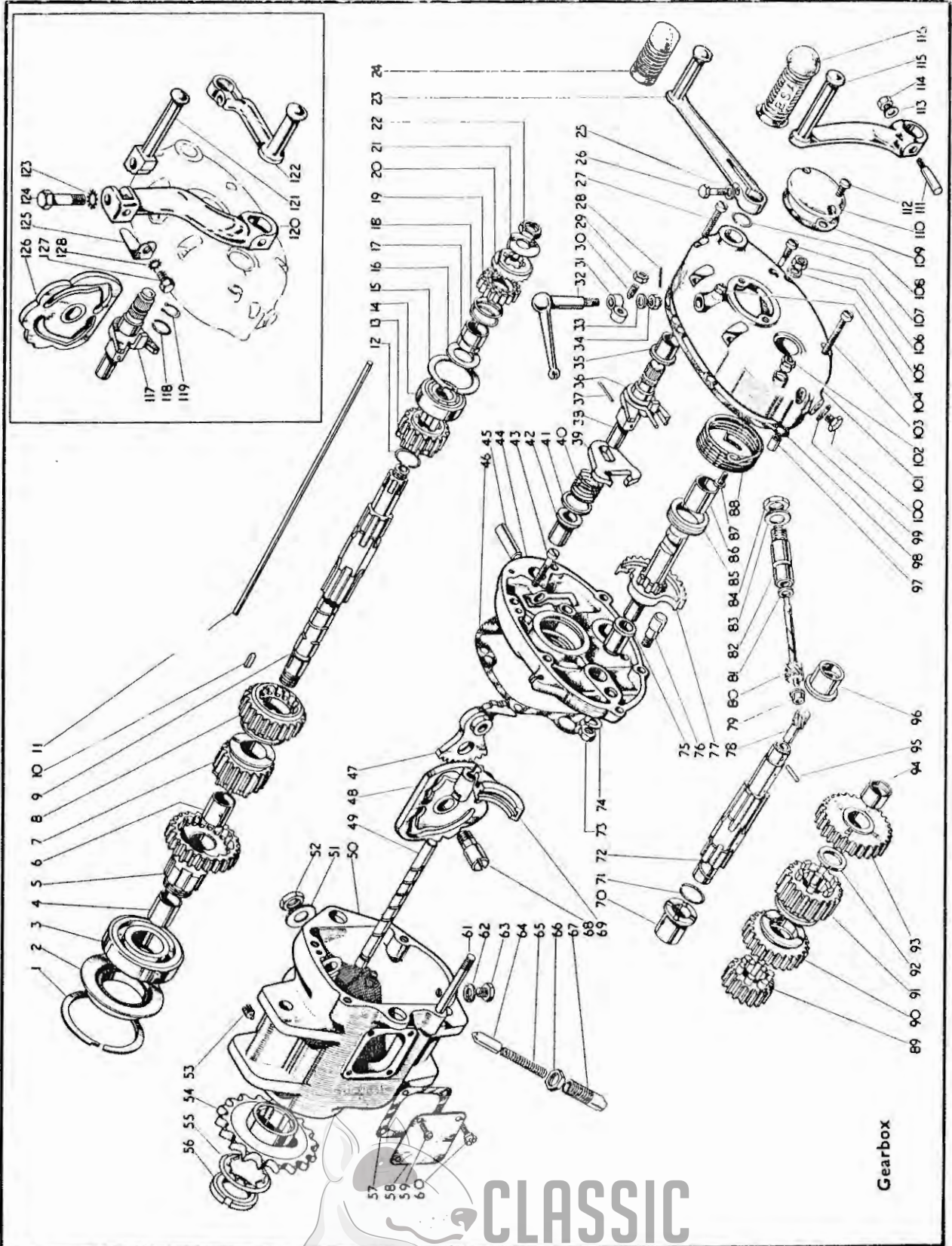

Plate Ref. Number.	Models.	Part No.	Description.	Number per set.
15	350c.c. 500c.c.	67-3028	Mainshaft bearing spring ring	1
16	350c.c. 500c.c.	67-3161	Kickstarter ratchet pinion sleeve washer	1
17	350c.c. 500c.c.	67-3169	Kickstarter ratchet pinion bush	1
18	350c.c. 500c.c.	67-3162	Kickstarter ratchet spring	1
19	350c.c. 500c.c.	67-3168	Kickstarter ratchet pinion	1
20	350c.c. 500c.c.	67-3167	Kickstarter ratchet	1
21	350c.c. 500c.c.	67-3164	Kickstarter ratchet and mainshaft lockwasher	1
22	350c.c. 500c.c.	67-3163	Kickstarter ratchet and mainshaft nut	1
23	350c.c. 500c.c.	65-3380	Gearchange operating lever	1
24	350c.c. 500c.c.	29-3250	Foot operating lever rubber	1
25	350c.c. 500c.c.	2-525	Foot operating lever screw washer	1
26	350c.c. 500c.c.	65-3361	Selector lever foot operating screw	1
27	350c.c. 500c.c.	65-3061	Outer cover fixing screw (long)	2
28	350c.c. 500c.c.	35-702	Clutch push rod lever nut split pin	1
29	350c.c. 500c.c.	3-720	Clutch push rod lever adjusting screw nut	1
30	350c.c. 500c.c.	65-3403	Clutch push rod adjusting screw complete	1
31	350c.c. 500c.c.	65-3360	Clutch push rod lever	1
32	350c.c. 500c.c.	67-3180	Clutch operating lever complete	1
33	350c.c. 500c.c.	2-525	Clutch push rod lever washer	1
34	350c.c. 500c.c.	15-1485	Clutch push rod lever nut	1
35	350c.c. 500c.c.	67-3353	Gearchange lever spindle bush	1
36	350c.c. 500c.c.	67-3340	Footchange stop plate return spring	1
37	350c.c. 500c.c.	35-709	Gear selector plate spring washer split pin	1
38	350c.c. 500c.c.	67-3335	Selector spindle complete (Clubmans excepted)	1
39	350c.c. 500c.c.	67-3341	Gear selector plate	1
40	350c.c. 500c.c.	67-3342	Gear selector plate spring	1
41	350c.c. 500c.c.	24-868	Gear selector plate spring washer	1
42	350c.c. 500c.c.	67-3170	Footchange lever spindle bush	1
43	350c.c. 500c.c.	65-2157	Gearbox inner cover retaining screw	1
44	350c.c. 500c.c.	67-3344	Gearbox inner cover complete	1
45	350c.c. 500c.c.	67-3350	Gearchange quadrant pivot pin	1
46	350c.c. 500c.c.	67-3346	Gearbox inner cover joint washer (paper)	1
47	350c.c. 500c.c.	67-3347	Gearchange quadrant complete	1
48	350c.c. 500c.c.	67-3332	Gear control cam plate complete	1
49	350c.c. 500c.c.	67-3116	Gear shifter fork shaft	1
50	350c.c. 500c.c.	42-3006	Gearbox casing with fixed fittings	1
—	350c.c. 500c.c.	42-3008	Gearbox casing with fixed fittings (reversed footchange)	1
51	350c.c. 500c.c.	67-3328	Gear cam plate pivot pin washer	1
52	350c.c. 500c.c.	24-7000	Gear cam plate pivot pin nut	1
53	350c.c. 500c.c.	67-3117	Gear shifter fork shaft grub screw	1
54	350c.c. 500c.c.	42-3015	Gearbox sprocket (16T) (Trials and Scrambles)	1
—	350c.c. 500c.c.	42-3016	Gearbox sprocket (19T) (Clubmans and Road Racing)	1
55	350c.c. 500c.c.	24-4263	Gearbox sprocket locking washer	1
56	350c.c. 500c.c.	67-3053	Gearbox sprocket nut	1
57	350c.c. 500c.c.	29-3449	Gearbox inspection cover washer	1
58	350c.c. 500c.c.	29-3448	Gearbox inspection cover	1
59	350c.c. 500c.c.	2-498	Gearbox inspection cover screw	1
60	350c.c. 500c.c.	27-4258	Gearbox inspection cover screw	3
61	350c.c. 500c.c.	67-3023	Gearbox outer cover stud	4
62	350c.c. 500c.c.	2-4553	Oil level drain plug washer (fibre)	1
63	350c.c. 500c.c.	28-243	Gearbox drain plug	1
64	350c.c. 500c.c.	67-3119	Gearbox control cam plate plunger	1
65	350c.c. 500c.c.	67-3121	Gear control cam plate plunger spring	1
66	350c.c. 500c.c.	67-3122	Gear control cam plate plunger housing nut	1
67	350c.c. 500c.c.	67-3120	Gear control cam plate plunger housing	1
68	350c.c. 500c.c.	67-3327	Gear cam plate pivot pin	1
69	350c.c. 500c.c.	67-3204	Gear shifter fork	2
70	350c.c. 500c.c.	67-3230	Layshaft bush	1
71	350c.c. 500c.c.	67-3101	Layshaft gear locating ring	1
72	350c.c. 500c.c.	42-3018	Layshaft complete with gear (17T)	1
—	350c.c. 500c.c.	42-3019	Layshaft only	1
—	350c.c. 500c.c.	42-3034	Layshaft complete with gear (Clubmans and Road Racing) (extra close).	1
—	350c.c. 500c.c.	42-3018	Layshaft complete with gear (Trials)	1
—	350c.c. 500c.c.	42-3021	Layshaft complete with gear (Scrambles)	1
73	350c.c. 500c.c.	2-49	Kickstarter quadrant stop nut	1
74	350c.c. 500c.c.	24-8784	Kickstarter quadrant stop washer	1
75	350c.c. 500c.c.	67-3151	Kickstarter spindle bush	1
76	350c.c. 500c.c.	67-3352	Kickstarter quadrant stop	1
77	350c.c. 500c.c.	42-3035	Kickstarter crank spindle with quadrant (Clubmans and Road Racing).	1
—	350c.c. 500c.c.	67-3178	Kickstarter crank spindle assembly (Clubmans excepted)	1
78	350c.c. 500c.c.	67-3088	Speedometer driving gear (6T)	1



Plate 23—continued.

GEARBOX—continued.

350c.c. and 500c.c. Gold Star (Swinging Arm)

Plate Ref. Number.	Models.	Part No.	Description.	Number per set.
—	350c.c. 500c.c.	67-3088	Speedometer driving gear (6T) (Trials and Scrambles)	1
—	350c.c. 500c.c.	42-3033	Speedometer driving gear (6T) (Clubmans and Road Racing) (extra close).	1
79	350c.c. 500c.c.	65-3377	Speedometer gear bush	1
80	350c.c. 500c.c.	42-3032	Speedometer driven gear (10T) (Clubmans and Road Racing) (extra close).	1
—	350c.c. 500c.c.	67-3175	Speedometer driven gear (11T) (Clubmans and Road Racing) (excepted).	1
81	350c.c. 500c.c.	65-3375	Speedometer driven gear thrust washer	1
82	350c.c. 500c.c.	65-3390	Speedometer driven gear bush	1
83	350c.c. 500c.c.	65-3392	Speedometer driven gear bush washer (fibre)	1
84	350c.c. 500c.c.	65-3391	Speedometer driven gear bush nut	1
85	350c.c. 500c.c.	67-3173	Kickstarter spindle sleeve	1
86	350c.c. 500c.c.	67-3153	Kickstarter lever spindle bush	1
87	350c.c. 500c.c.	2-3718	Kickstarter spring screw	1
88	350c.c. 500c.c.	67-3174	Kickstarter spring	1
89	350c.c. 500c.c.	42-3020	Layshaft gear (17T) (Trials)	1
—	350c.c. 500c.c.	42-3022	Layshaft gear (18T) (Scrambles)	1
90	350c.c. 500c.c.	42-3023	Layshaft sliding gear (23T)	1
—	350c.c. 500c.c.	42-3026	Layshaft sliding gear (21T) (Clubmans and Road Racing) (extra close).	1
—	350c.c. 500c.c.	42-3025	Layshaft sliding gear (26T) (Trials)	1
—	350c.c. 500c.c.	42-3024	Layshaft sliding gear (24T) (Scrambles)	1
—	350c.c. 500c.c.	67-3198	Layshaft sliding gear (19T) (Clubmans and Road Racing) (extra close).	1
—	350c.c. 500c.c.	67-3212	Layshaft sliding gear (21T) (Trials and Scrambles)	1
91	350c.c. 500c.c.	67-3198	Layshaft sliding gear (19T)	1
92	350c.c. 500c.c.	67-3203	Layshaft thrust washer	1
93	350c.c. 500c.c.	67-3199	Layshaft gear complete (27T)	1
—	350c.c. 500c.c.	67-3216	Layshaft gear complete (25T) (Clubmans and Road Racing) (extra close).	1
—	350c.c. 500c.c.	67-3213	Layshaft gear complete (29T) (Trials)	1
—	350c.c. 500c.c.	67-3199	Layshaft gear complete (27T) (Scrambles)	1
94	350c.c. 500c.c.	67-3093	Layshaft gear bush	1
95	350c.c. 500c.c.	67-3128	Speedometer gear layshaft peg	1
96	350c.c. 500c.c.	67-3099	Layshaft bush	1
97	350c.c. 500c.c.	66-3074	Dowel	2
98	350c.c. 500c.c.	67-3354	Gearbox outer cover joint washer (paper)	1
99	350c.c. 500c.c.	2-4553	Oil level plug washer (fibre)	1
100	350c.c. 500c.c.	28-243	Oil level plug	1
101	350c.c. 500c.c.	67-3351	Gearbox outer cover complete	1
102	350c.c. 500c.c.	27-4401	Kickstarter spring screw locknut	1
103	350c.c. 500c.c.	67-1705	Outer cover fixing screw (short)	1
104	350c.c. 500c.c.	28-2080	Grease nipple	1
105	350c.c. 500c.c.	2-923	Outer cover fixing nut washer	4
106	350c.c. 500c.c.	67-3034	Outer cover fixing nut	4
107	350c.c. 500c.c.	67-3176	Speedometer driven gear retaining pin	1
108	350c.c. 500c.c.	15-4240	Gearchange operating spindle circlip	1
109	350c.c. 500c.c.	67-3033	Inspection cover joint washer (fibre)	1
110	350c.c. 500c.c.	67-3024	Inspection cover	1
111	350c.c. 500c.c.	2-2579	Kickstarter crank cotter	1
112	350c.c. 500c.c.	24-7178	Inspection cover fixing screw	2
113	350c.c. 500c.c.	15-5155	Kickstarter crank cotter washer (plain)	1
114	350c.c. 500c.c.	2-2578	Kickstarter crank cotter nut	1
115	350c.c. 500c.c.	65-3381	Kickstarter pedal	1
116	350c.c. 500c.c.	65-3397	Kickstarter pedal rubber	1
117	350c.c. 500c.c.	42-3013	Selector lever spindle complete (Clubmans only)	1
118	350c.c. 500c.c.	15-4240	Gearchange operating spindle circlip	1
119	350c.c. 500c.c.	67-3215	Selector lever spindle circlip (Clubmans only)	1
120	350c.c. 500c.c.	65-3459	Kickstarter crank complete (folding type) (Clubmans and Road Racing) (excepted).	1
—	350c.c. 500c.c.	65-3460	Kickstarter crank only (Clubmans and Road Racing) (excepted)	1
—	350c.c. 500c.c.	42-3037	Kickstarter crank complete (folding type) (Clubmans and Road Racing).	1
—	350c.c. 500c.c.	42-3038	Kickstarter crank only (folding type) (Clubmans and Road Racing).	1
121	350c.c. 500c.c.	65-3427	Kickstarter crank pedal	1
122	350c.c. 500c.c.	42-3017	Footchange operating lever (reversed position)	1
123	350c.c. 500c.c.	66-4707	Kickstarter pedal washer (shakeproof)	1
124	350c.c. 500c.c.	29-5156	Kickstarter pedal bolt	1
125	350c.c. 500c.c.	65-3428	Kickstarter pedal spring	1
126	350c.c. 500c.c.	42-3011	Gear control cam plate complete (reversed footchange)	1
127	350c.c. 500c.c.	2-220	Kickstarter crank spring bolt	1
128	350c.c. 500c.c.	29-541	Kickstarter crank spring bolt washer	1

Plate 24

CLUTCH and FRONT CHAINCASE

350c.c. and 500c.c. Gold Star (Swinging Arm)

Plate Ref. Number.	Models.	Part No.	Description.	Number per set.
1	350c.c. 500c.c.	67-1706	Primary chaincase front fixing screw	2
		67-1711	Primary chaincase oil level and drain screw	2
2	350c.c. 500c.c.	67-1709	Primary chaincase oil level and drain washer (fibre)	3
3	350c.c. 500c.c.	65-3063	Primary chaincase front fixing screw	8
4	350c.c. 500c.c.	2-2395	Clutch spring retaining stud nut	12
5	350c.c. 500c.c.	66-3800	Clutch spring	6
6	350c.c. 500c.c.	66-3781	Clutch spring cup	6
7	350c.c. 500c.c.	65-3828	Clutch actuating cap complete	1
8	350c.c. 500c.c.	65-3858	Clutch plate ferodo inserts	96
9	350c.c. 500c.c.	65-3911	Clutch ballrace inner ring	1
10	350c.c. 500c.c.	65-3910	Clutch ballrace ring	2
11	350c.c. 500c.c.	66-3891	Clutch chainwheel ferodo insert	24
12	350c.c.	24-8716	Primary chain (Trials and Scrambles)	1
—	350c.c.	24-8930	Primary chain (Clubmans and Road Racing)	1
—	500c.c.	24-8716	Primary chain (Trials and Scrambles)	1
—	500c.c.	24-8931	Primary chain (Clubmans and Road Racing)	1
13	350c.c. 500c.c.	65-3873	Clutch sleeve	1
14	350c.c. 500c.c.	65-3833	Clutch sleeve collar	1
15	350c.c. 500c.c.	66-7523	Primary chaincase sliding plate bolt	2
16	350c.c. 500c.c.	2-1462	Primary chaincase sliding plate bolt washer	2
17	350c.c. 500c.c.	2-443	Primary chaincase sliding plate bolt nut	2
18	350c.c. 500c.c.	65-109	Primary chaincase back fixing bolt	1
19	350c.c. 500c.c.	15-7563	Primary chaincase back fixing distance collar	1
20	350c.c. 500c.c.	35-33	Primary chaincase back fixing bolt washer	1
21	350c.c. 500c.c.	2-49	Primary chaincase back fixing bolt nut	1
22	350c.c. 500c.c.	66-3074	Primary chaincase dowel	2
23	350c.c. 500c.c.	42-7502	Primary chaincase (back)	1
24	350c.c. 500c.c.	42-7504	Primary chaincase back washer (felt)	1
25	350c.c. 500c.c.	66-7520	Primary chaincase sliding plate complete	1
26	350c.c. 500c.c.	65-3872	Clutch plate	1
27	350c.c. 500c.c.	66-3908	Clutch chainwheel	1
28	350c.c. 500c.c.	65-3912	Clutch ballrace ring	1
29	350c.c. 500c.c.	42-7507	Primary chaincase joint washer (paper)	1
30	350c.c. 500c.c.	65-3824	Clutch driven plate	4
31	350c.c. 500c.c.	65-3857	Clutch driving plate with inserts	4
32	350c.c. 500c.c.	66-3903	Clutch driving plate centre with studs	1
33	350c.c. 500c.c.	65-3822	Mainshaft locking washer nut	1
34	350c.c. 500c.c.	66-3787	Mainshaft nut	1
35	350c.c. 500c.c.	65-3365	Primary chaincase inspection cap washer	1
36	350c.c. 500c.c.	65-3364	Primary chaincase inspection cap	1
37	350c.c. 500c.c.	42-7508	Primary chaincase front fixing screw	3
38	350c.c. 500c.c.	42-7506	Primary chaincase (front)	1
39	350c.c. 500c.c.	66-7575	Primary chaincase and crankcase joint washer	1
40	350c.c. 500c.c.	24-8784	Primary chaincase securing bolt washer	3
41	350c.c. 500c.c.	67-4028	Primary chaincase back securing bolt	3

Plate 25

FRAME and FITTINGS

350c.c. and 500c.c. Gold Star (Swinging Arm)

Plate Ref. Number.	Models.	Part No.	Description.	Number per set.
1	350c.c. 500c.c. Gold Star	65-4182	Rear engine and gearbox plate stud (top and bottom rear)	2
2	350c.c. 500c.c. Gold Star	2-1733	Rear engine and gearbox plate stud washer (plain) (top and bottom rear).	4
3	350c.c. 500c.c. Gold Star	42-4814	Footrest hanger stud (offside) (when footrests in rear position)	1
4	350c.c. 500c.c. Gold Star	2-522	Rear engine and gearbox plate stud washer (spring) (top and bottom rear).	4
5	350c.c. 500c.c. Gold Star	2-46	Rear engine and gearbox plate stud nut (top and bottom rear)	4
6	350c.c. 500c.c. Gold Star	42-4816	Rear engine plate stud (when footrests in rear position)	1
7	350c.c. 500c.c. Gold Star	15-5753	Rear engine plate stud nut (when footrests in rear position)	2

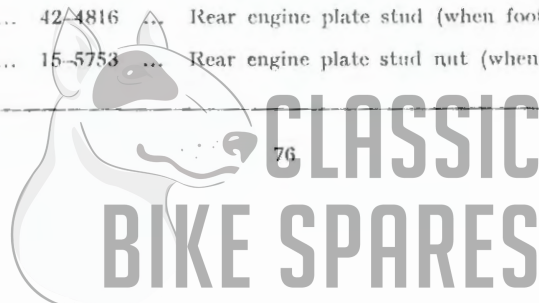

CLUTCH and FRONT CHAINCASE

350c.c. and 500c.c. Gold Star (Swinging Arm)

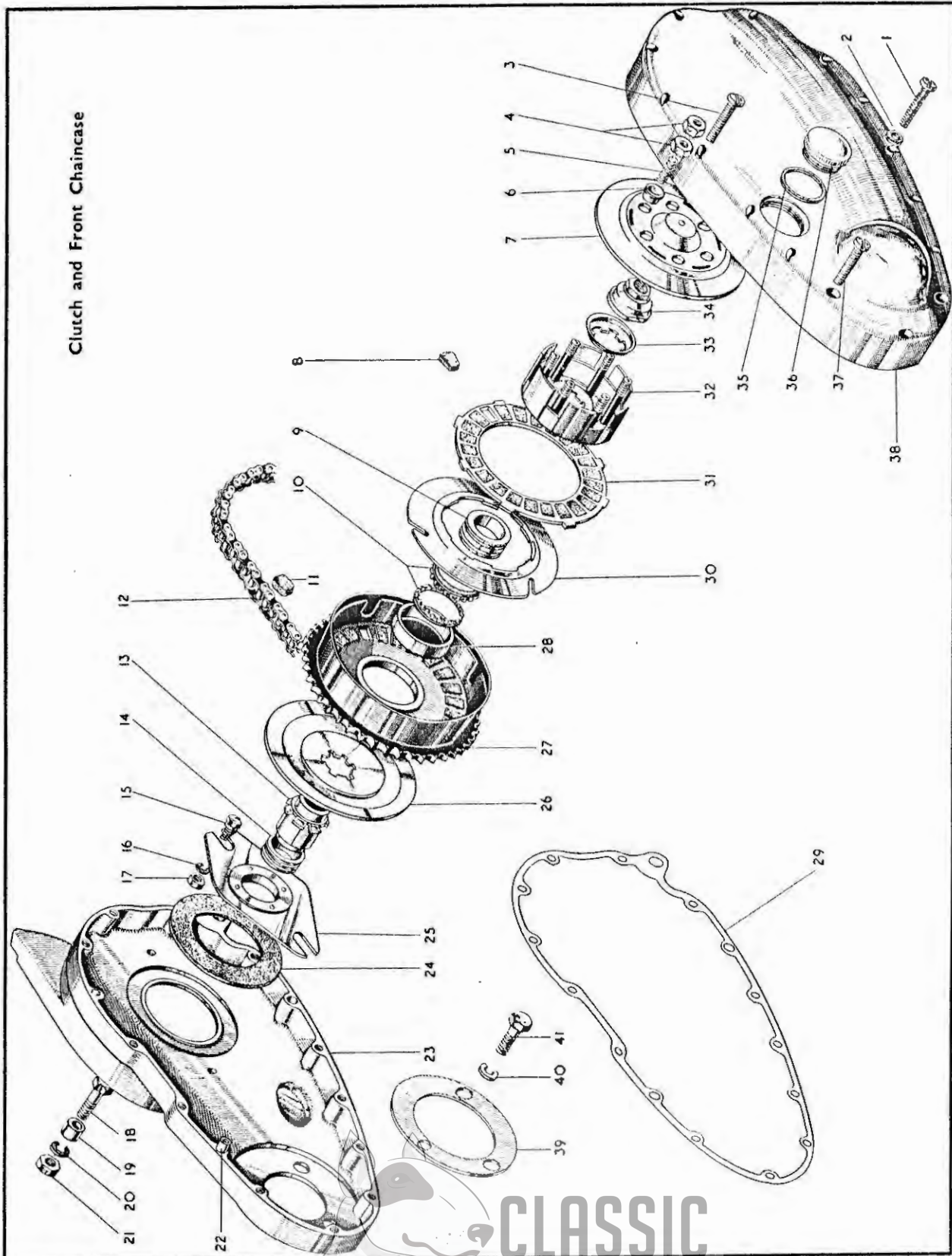
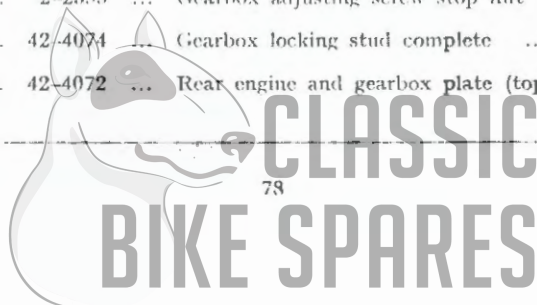

Plate 25—continued.

FRAME and FITTINGS—continued.

350c.c. and 500c.c. Gold Star (Swinging Arm)

Plate Ref. Number.	Models.	Part No.	Description.	Number per set.
8	350c.c. 500c.c. Gold Star	65-695	Rear engine plate stud washer (shakeproof) (when footrests in rear position).	2
9	350c.c. 500c.c. Gold Star	2-440	Gearbox pivot stud nut	2
10	350c.c. 500c.c. Gold Star	2-1967	Gearbox pivot stud washer (spring)	2
11	350c.c. 500c.c. Gold Star	2-1945	Gearbox pivot stud washer (plain)	2
12	350c.c. 500c.c. Gold Star	42-4077	Gearbox pivot stud	1
13	350c.c. 500c.c. Gold Star	27-5683	Rear engine and gearbox plate stud (bottom front)	1
14	350c.c. 500c.c. Gold Star	27-5683	Crankcase rear fixing stud (bottom)	1
15	350c.c. 500c.c. Gold Star	2-1733	Rear engine and gearbox plate stud washer (plain) (bottom front).	2
16	350c.c. 500c.c. Gold Star	2-522	Rear engine and gearbox plate stud washer (spring) (bottom front).	2
17	350c.c. 500c.c. Gold Star	2-46	Rear engine and gearbox plate stud nut (bottom front)	2
18	350c.c. 500c.c. Gold Star	2-46	Crankcase rear fixing stud nut (bottom)	2
19	350c.c. 500c.c. Gold Star	2-522	Crankcase rear fixing stud washer (spring) (bottom)	2
20	350c.c. 500c.c. Gold Star	2-1733	Crankcase rear fixing stud washer (plain) (bottom)	2
21	350c.c. 500c.c. Gold Star	27-5683	Crankcase fixing stud (front) (when crankcase shield fitted)	1
22	350c.c. 500c.c. Gold Star	2-1309	Front engine plate cover screw	6
23	350c.c. 500c.c. Gold Star	29-3319	Front engine plate cover screw washer (shakeproof)	6
24	350c.c. 500c.c. Gold Star	42-4063	Front engine plate cover complete	1
25	350c.c. 500c.c. Gold Star	42-4071	Front engine plate distance collar	2
26	350c.c. 500c.c. Gold Star	42-4068	Front engine plate complete (offside)	1
—	350c.c. 500c.c. Gold Star	42-4066	Front engine plate complete (nearside)	1
27	350c.c. 500c.c. Gold Star	2-46	Crankcase rear fixing stud nut (top)	2
28	350c.c. 500c.c. Gold Star	2-522	Crankcase rear fixing stud washer (spring) (top)	2
29	350c.c. 250c.c. Gold Star	2-1733	Crankcase rear fixing stud washer (plain) (top)	2
30	350c.c. 500c.c. Gold Star	2-440	Gearbox locking stud nut	1
31	350c.c. 500c.c. Gold Star	2-1967	Gearbox locking stud washer (spring)	1
32	350c.c. 500c.c. Gold Star	42-4073	Rear engine and gearbox plate (bottom)	2
33	350c.c. 500c.c. Gold Star	65-4182	Crankcase rear fixing stud (top)	1
34	350c.c. 500c.c. Gold Star	42-4076	Gearbox adjusting screw	1
35	350c.c. 500c.c. Gold Star	42-4075	Gearbox locking stud washer (serrated)	1
36	350c.c. 500c.c. Gold Star	2-1616	Gearbox adjusting screw locknut	1
37	350c.c. 500c.c. Gold Star	15-5664	Gearbox adjusting screw nut	1
38	350c.c. 500c.c. Gold Star	27-5705	Gearbox adjusting screw stop	1
39	350c.c. 500c.c. Gold Star	2-1462	Gearbox adjusting screw stop washer (spring)	1
40	350c.c. 500c.c. Gold Star	2-2395	Gearbox adjusting screw stop nut	1
41	350c.c. 500c.c. Gold Star	42-4074	Gearbox locking stud complete	1
42	350c.c. 500c.c. Gold Star	42-4072	Rear engine and gearbox plate (top)	2



FRAME and FITTINGS
350c.c. and 500c.c. Gold Star (Swinging Arm)

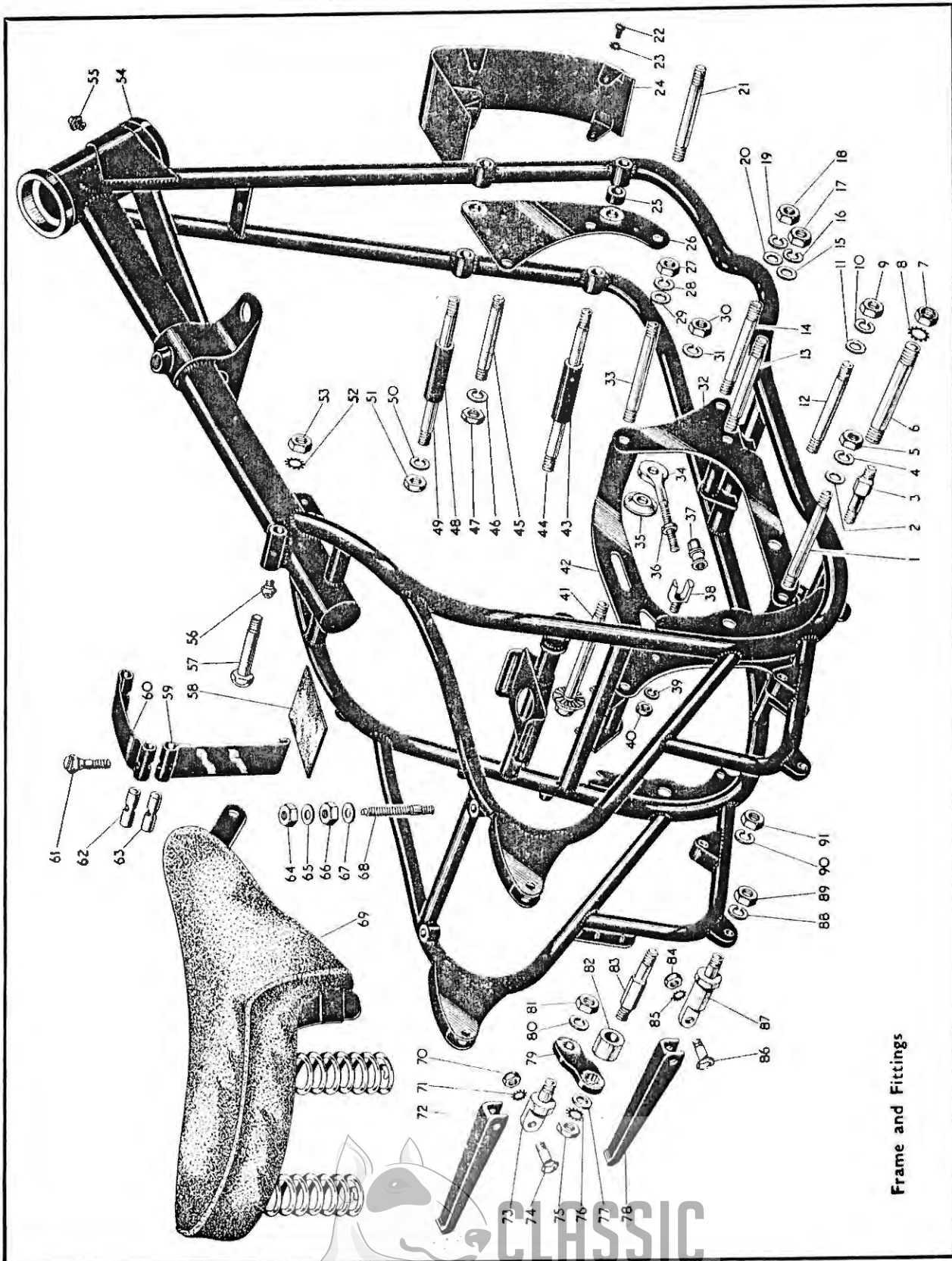

Frame and Fittings

Plate Ref. Number.	Models.	Part No.	Description.	Number per set.
43	350c.c. 500c.c. Gold Star	42-4070	Front engine plate distance tube	1
44	350c.c. 500c.c. Gold Star	42-4099	Front engine plate (bottom) and horn fixing stud	1
—	350c.c. 500c.c. Gold Star	27-6274	Front engine plate stud (bottom) (when horn is not fitted)	1
45	350c.c. 500c.c. Gold Star	27-5684	Crankcase fixing stud (front)	3
46	350c.c. 500c.c. Gold Star	2-522	Crankcase front fixing stud washer (spring)	6
47	350c.c. 500c.c. Gold Star	2-46	Crankcase front fixing stud nut	6
48	350c.c. 500c.c. Gold Star	42-4070	Front engine plate distance tube	1
49	350c.c. 500c.c. Gold Star	27-5690	Front engine plate stud (top)	1
50	350c.c. 500c.c. Gold Star	2-522	Front engine plate stud washer (spring)	4
51	350c.c. 500c.c. Gold Star	2-46	Front engine plate stud nut	4
52	350c.c. 500c.c. Gold Star	66-4707	Saddle front fixing bolt washer (shakeproof)	1
53	350c.c. 500c.c. Gold Star	2-46	Saddle front fixing bolt nut	1
54	350c.c. 500c.c. Gold Star	42-4002	Frame complete with fixed fittings	1
55	350c.c. 500c.c. Gold Star	28-2080	Ball head grease nipple	1
56	350c.c. 500c.c. Gold Star	28-2080	Saddle front bolt grease nipple	1
57	350c.c. 500c.c. Gold Star	67-4030	Saddle front fixing bolt	1
58	350c.c. 500c.c. Gold Star	42-4507	Rubber strip for battery platform	1
59	350c.c. 500c.c. Gold Star	42-4503	Battery carrier strap (side)	2
60	350c.c. 500c.c. Gold Star	42-4502	Battery carrier strap (top)	1
61	350c.c. 500c.c. Gold Star	42-4504	Battery carrier strap bolt	2
62	350c.c. 500c.c. Gold Star	42-4505	Battery carrier swivel pin (plain)	2
63	350c.c. 500c.c. Gold Star	42-4506	Battery carrier swivel pin (tapped)	2
64	350c.c. 500c.c. Gold Star	2-49	Saddle rear fixing stud nut (when saddle fitted)	2
65	350c.c. 500c.c. Gold Star	2-923	Saddle rear fixing stud washer (plain) (when saddle fitted)	2
66	350c.c. 500c.c. Gold Star	2-49	Saddle rear fixing stud nut (when saddle fitted)	2
67	350c.c. 500c.c. Gold Star	2-923	Saddle rear fixing stud washer (plain) (when saddle fitted)	2
68	350c.c. 500c.c. Gold Star	67-4040	Saddle rear fixing stud (when saddle fitted)	2
69	350c.c. 500c.c. Gold Star	42-9032	Saddle	1
70	350c.c. 500c.c. Gold Star	24-6040	Folding footrest swivel bolt nut (when footrest in rear position)	2
71	350c.c. 500c.c. Gold Star	36-382	Folding footrest swivel bolt washer (shakeproof) (when footrests in rear position).	2
72	350c.c. 500c.c. Gold Star	29-7561	Folding footrest with stiffening piece (when footrests in rear position).	2
73	350c.c. 500c.c. Gold Star	65-4917	Footrest anchor bolt (when footrests in rear position)	2
74	350c.c. 500c.c. Gold Star	29-7564	Folding footrest swivel bolt (when footrests in rear position)	2
75	350c.c. 500c.c. Gold Star	2-46	Footrest hanger stud nut (when footrests in rear position)	2
76	350c.c. 500c.c. Gold Star	66-4707	Footrest hanger stud washer (shakeproof) (when footrests in rear position).	2
77	350c.c. 500c.c. Gold Star	2-861	Footrest hanger stud washer (plain) (when footrests in rear position).	2

Plate 25—continued.

FRAME and FITTINGS—continued.
350c.c. and 500c.c. Gold Star (Swinging Arm)

Plate Ref. Number.	Models.	Part No.	Description.	Number per set.
78	350c.c. 500c.c. Gold Star	29-7561	Pillion footrest with stiffening piece	2
79	350c.c. 500c.c. Gold Star	42-4812	Footrest hanger bracket (when footrests in rear position)	2
80	350c.c. 500c.c. Gold Star	2-522	Footrest anchor bolt washer (spring) (when footrests in rear position).	2
81	350c.c. 500c.c. Gold Star	2-46	Footrest anchor bolt nut (when footrests in rear position)	2
82	350c.c. 500c.c. Gold Star	42-4815	Footrest hanger stud distance tube (nearside) (when footrests in rear position).	1
83	350c.c. 500c.c. Gold Star	42-4813	Footrest hanger stud (nearside) (when footrests in rear position)	1
84	350c.c. 500c.c. Gold Star	24-6040	Pillion footrest swivel bolt nut	2
85	350c.c. 500c.c. Gold Star	36-382	Pillion footrest swivel bolt washer (shakeproof)	2
86	350c.c. 500c.c. Gold Star	29-7564	Pillion footrest swivel bolt	2
87	350c.c. 500c.c. Gold Star	29-7560	Pillion footrest anchor bolt	2
88	350c.c. 500c.c. Gold Star	2-522	Pillion footrest anchor bolt washer (spring)	2
89	350c.c. 500c.c. Gold Star	2-46	Pillion footrest anchor bolt nut	2
90	350c.c. 500c.c. Gold Star	2-522	Footrest hanger stud washer (spring) (when footrests in rear position).	2
91	350c.c. 500c.c. Gold Star	2-46	Footrest hanger stud nut (when footrests in rear position)	2
	350c.c. 500c.c. Gold Star	66-4149	Ball head cup	2

Plate 26

FRAME and FITTINGS
350c.c. and 500c.c. Gold Star (Swinging Arm)

Plate Ref. Number.	Models.	Part No.	Description.	Number per set.
1	350c.c. 500c.c. Gold Star	42-4702	Central stand complete	1
2	350c.c. 500c.c. Gold Star	28-2080	Central stand grease nipple	1
3	350c.c. 500c.c. Gold Star	65-4727	Central stand spring	1
4	350c.c. 500c.c. Gold Star	42-4713	Central stand distance tube	1
5	350c.c. 500c.c. Gold Star	42-4714	Central stand pivot stud	1
6	350c.c. 500c.c. Gold Star	2-1945	Central stand pivot stud washer (plain)	1
7	350c.c. 500c.c. Gold Star	2-1967	Central stand pivot stud washer (spring)	1
8	350c.c. 500c.c. Gold Star	24-5860	Central stand pivot stud nut	2
9	350c.c. 500c.c. Gold Star	42-4712	Central stand bush	2
10	350c.c. 500c.c. Gold Star	42-4806	Footrest distance tube complete (offside) (when footrests in forward position).	1
11	350c.c. 500c.c. Gold Star	42-4804	Footrest bracket (offside) (when footrests in forward position)	1
12	350c.c. 500c.c. Gold Star	42-4808	Footrest stud complete (when footrests in forward position)	1
13	350c.c. 500c.c. Gold Star	42-4116	Swinging arm fork spindle locknut	1
14	350c.c. 500c.c. Gold Star	42-4117	Swinging arm fork spindle washer	1
15	350c.c. 500c.c. Gold Star	29-7551	Footrest rubber (when footrests in forward position)	1



CLASSIC
BIKE SPARES

FRAME and FITTINGS
350c.c. and 500c.c. Gold Star (Swinging Arm)

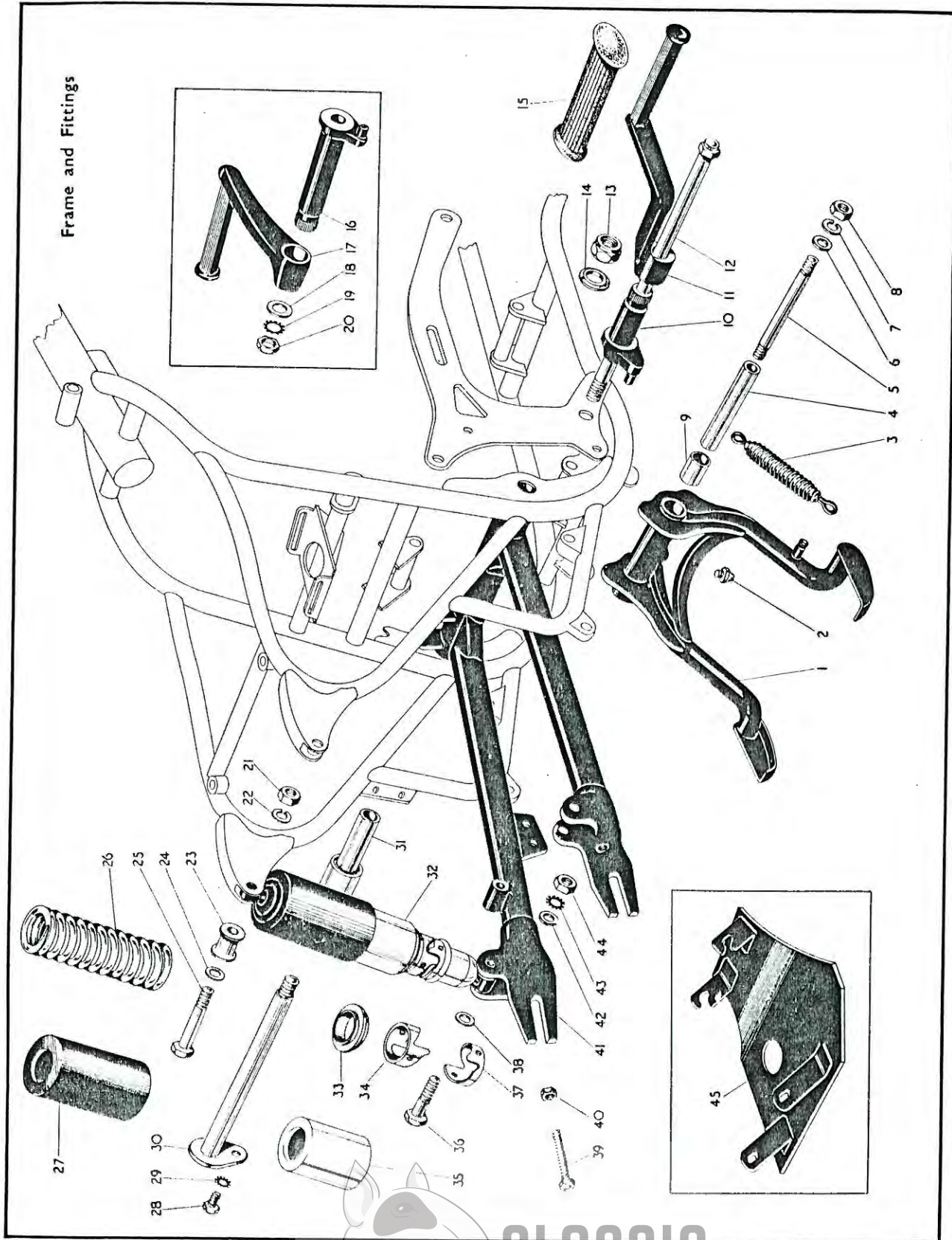

Plate 26—continued.

FRAME and FITTINGS—continued.
350c.c and 500c.c. Gold Star (Swinging Arm)

Plate Ref. Number.	Models.	Part No.	Description.	Number per set.
16	350c.c. 500c.c. Gold Star	65-4811	Footrest distance tube complete (nearside) (when footrests in forward position).	1
17	350c.c. 500c.c. Gold Star	42-4805	Footrest bracket (nearside) (when footrests in forward position)	1
18	350c.c. 500c.c. Gold Star	24-5914	Footrest stud washer (plain) (when footrests in forward position)	2
19	350c.c. 500c.c. Gold Star	65-695	Footrest stud washer (shakeproof) (when footrests in forward position).	1
20	350c.c. 500c.c. Gold Star	15-5753	Footrest stud nut (when footrests in forward position)	1
21	350c.c. 500c.c. Gold Star	1-1796	Rear mudguard stay bracket and damper top fixing bolt nut...	2
22	350c.c. 500c.c. Gold Star	2-522	Rear mudguard stay bracket and damper top fixing bolt washer (spring).	2
23	350c.c. 500c.c. Gold Star	42-6763	Rear mudguard stay bracket and damper top fixing bolt distance piece.	2
24	350c.c. 500c.c. Gold Star	2-1733	Rear mudguard stay bracket and damper top fixing bolt washer (plain).	2
25	350c.c. 500c.c. Gold Star	65-4185	Rear mudguard stay bracket and damper fixing bolt (top)	2
26	350c.c. 500c.c. Gold Star Clubmans	42-4143	Rear suspension damper spring (Standard)	2
—	350c.c. 500c.c. Gold Star Clubmans	42-4144	Rear suspension damper spring (Lightweight)	2
—	350c.c. 500c.c. Scrambles	42-4142	Rear suspension damper spring	2
27	350c.c. 500c.c. Gold Star Clubmans	42-4148	Rear suspension outer shroud	2
—	350c.c. 500c.c. Scrambles	42-4148	Rear suspension outer shroud	2
28	350c.c. 500c.c. Gold Star	66-2010	Swinging arm fork spindle securing bolt	1
29	350c.c. 500c.c. Gold Star	36-382	Swinging arm fork spindle securing bolt washer (shakeproof)	1
30	350c.c. 500c.c. Gold Star	42-4112	Swinging arm fork spindle complete	1
31	350c.c. 500c.c. Gold Star	42-4115	Swinging arm housing "silent bloc"	2
32	350c.c. 500c.c. Gold Star Clubmans	42-4138	Rear suspension damper complete (Standard)	2
—	350c.c. 500c.c. Gold Star Clubmans	42-4139	Rear suspension damper complete (Lightweight)	2
—	350c.c. 500c.c. Scrambles	42-4136	Rear suspension damper complete	2
33	350c.c. 500c.c. Gold Star Clubmans	42-4150	Rear suspension retainer (bottom)	2
—	350c.c. 500c.c. Scrambles	42-4150	Rear suspension retainer (bottom)	2
34	350c.c. 500c.c. Gold Star Clubmans	42-4152	Rear suspension damper spring adjuster (male)	2
—	350c.c. 500c.c. Scrambles	42-4152	Rear suspension damper spring adjuster (male)	2
35	350c.c. 500c.c. Gold Star Clubmans	42-4149	Rear suspension inner shroud	2
—	350c.c. 500c.c. Scrambles	42-4149	Rear suspension inner shroud	2
36	350c.c. 500c.c. Gold Star	3-1399	Rear suspension damper bottom fixing bolt	2
37	350c.c. 500c.c. Gold Star Clubmans	42-4153	Rear suspension damper spring adjuster (female)	2
—	350c.c. 500c.c. Scrambles	42-4153	Rear suspension damper spring adjuster (female)	2

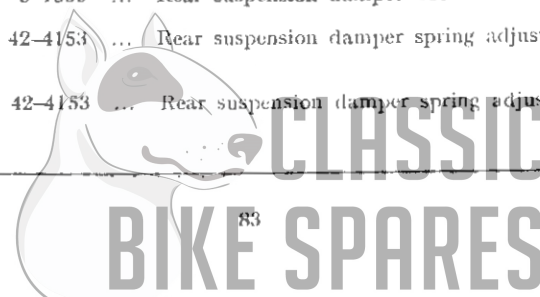

Plate Ref. Number.	Models.	Part No.	Description.	Number per set.
38 ...	350c.c. 500c.c. Gold Star	2-1733	Rear suspension damper bottom fixing bolt washer (plain)	2
39 ...	350c.c. 500c.c. Gold Star	67-4800	Rear wheel adjusting screw	2
40 ...	350c.c. 500c.c. Gold Star	1-6032	Rear wheel adjusting screw locknut	2
41 ...	350c.c. 500c.c. Gold Star	42-4102	Swinging arm complete	1
42 ...	350c.c. 500c.c. Gold Star	67-4129	Rear suspension damper bottom fixing bolt washer	2
43 ...	350c.c. 500c.c. Gold Star	66-4707	Rear suspension damper bottom fixing bolt washer (shakeproof)	2
44 ...	350c.c. 500c.c. Gold Star	2-46	Rear suspension damper bottom fixing bolt nut	2
45 ...	350c.c. 500c.c. Trials and Scrambles	42-2001	Crankcase shield complete	1

FRONT FORK and FITTINGS

350c.c. and 500c.c. Gold Star (Clubmans and Road Racing) (Swinging Arm).

As 1952 Gold Star Clubmans except the following:

(These items are not illustrated)

Models.	Part No.	Description.	Number per set.
350c.c. 500c.c. ...	42-5002	Front fork complete	1
350c.c. 500c.c. ...	29-5338	Fork shaft plug washer	2
350c.c. 500c.c. ...	65-5426	Steering damper knob securing plate	1
350c.c. 500c.c. ...	2-370	Handlebar clip and damper knob securing plate distance piece	2
350c.c. 500c.c. ...	42-5015	Front fork bottom yoke	1
350c.c. 500c.c. ...	2-204	Steering lock stop bolt	1
350c.c. 500c.c. ...	2-2395	Steering lock stop bolt nut	2
350c.c. 500c.c. ...	42-5011	Front fork top yoke	1
350c.c. 500c.c. ...	2-46	Front fork top yoke bolt nut	1
350c.c. 500c.c. ...	66-5204	Steering head dust cap	1
350c.c. 500c.c. ...	42-5014	Steering damper anchor plate	1
350c.c. 500c.c. ...	28-2338	Steering damper anchor plate bolt	1

Front Fork and Fittings (1953), Models 350c.c. and 500c.c. (7" brake), Trials and Scrambles (Swinging Arm). As 1952 Gold Star except the following:

350c.c. 500c.c. ...	42-5003	Front fork complete	1
350c.c. 500c.c. ...	42-5012	Front fork bottom yoke	1
350c.c. 500c.c. ...	65-5408	Front fork sliding tube (nearside)	1
350c.c. 500c.c. ...	65-5410	Front fork sliding tube (offside)	1

FRONT WHEELS and FITTINGS

350c.c. and 500c.c. Gold Star Clubmans and Road Racing (Swinging Arm). 8" Brake.

As 1952 Gold Star Clubmans except the following:

Models.	Part No.	Description.	Number per set.
350c.c. 500c.c. ...	42-5507	Front wheel complete (less brake and tyre) (steel rim) (19")	1
350c.c. 500c.c. ...	42-5508	Front wheel complete (less brake and tyre) (alloy rim) (19")	1
350c.c. 500c.c. ...	42-5509	Front wheel rim (steel) (19")	1
350c.c. 500c.c. ...	42-5510	Front wheel rim (alloy) (19")	1
350c.c. 500c.c. ...	67-5544	Front wheel spoke (short)	20
350c.c. 500c.c. ...	67-5545	Front wheel spoke (long)	20
350c.c. 500c.c. ...	27-6813	Front wheel spoke nipple	40
350c.c. 500c.c. ...	42-5520	Front brake anchor strap (21" wheel only)	1

Front Wheel and Fittings (1953), 350c.c. and 500c.c. Gold Star Trials and Scrambles (Swinging Arm) (7" brake), as 1952 B32-1334.



Plate 27

REAR HUB and WHEEL FITTINGS

350c.c. and 500c.c. Gold Star (Swinging Arm)

Plate Ref. Number.	Models.	Part No.	Description.	Number per set.
...	350c.c. 500c.c. Clubmans and Road Racing	42 6004	Rear wheel complete (less brake and tyre) (WM2"x19")	1
...	350c.c. 500c.c. Clubmans and Road Racing	67 6177	Rear wheel complete (less brake and tyre) (WM2"x19") (alloy)	1
...	350c.c. 500c.c. Trials and Scrambles	42 6001	Rear wheel complete (less brake and tyre) (WM3"x19")	1
1	350c.c. 500c.c.	2 440	Rear brake operating lever nut	1
2	350c.c. 500c.c.	66-4708	Rear brake operating lever washer (shakeproof)	1
3	350c.c. 500c.c.	15 431	Rear brake operating lever washer (plain)	1
4	350c.c. 500c.c.	65-5674	Cam bearing oil hole clip	1
5	350c.c. 500c.c.	21-431	Anchor strap bolt nut	1
6	350c.c. 500c.c.	2-130	Anchor strap bolt washer (plain)	1
7	350c.c. 500c.c.	42-6036	Rear brake anchor strap	1
8	350c.c. 500c.c.	35-698	Anchor strap bolt split pin	1
9	350c.c. 500c.c.	42-6037	Rear brake anchor strap bolt	1
10	350c.c. 500c.c.	42-6034	Rear brake cam	1
11	350c.c. 500c.c.	35-6436	Brake shoe lining rivet	14
12	350c.c. 500c.c.	65-5903	Brake shoe lining	2
13	350c.c. 500c.c. Clubmans and Road Racing	66-9160	Transmission chain (rear)	1
...	350c.c. 500c.c. Trials and Scrambles	66-9162	Transmission chain (rear)	1
14	350c.c. 500c.c.	65-5883	Rear hub ball bearing	1
15	350c.c. 500c.c.	67-6033	Hub ball journal shim	1
16	350c.c. 500c.c.	67-6034	Retaining spring ring	1
17	350c.c. 500c.c.	67-6030	Rear brake drum bearing sleeve	1
18	350c.c. 500c.c.	67-6101	Driving flange	1
19	350c.c. 500c.c.	65-5885	Hub ballrace retaining ring	1
20	350c.c. 500c.c.	27-6810	Spoke nipples	40
21	350c.c. 500c.c. Clubmans and Road Racing	65-6308	Rear wheel rim (WM2"x19") (alloy)	1
...	350c.c. 500c.c. Clubmans and Road Racing	42-6002	Rear wheel rim (WM3"x19")	1
22	350c.c. 500c.c. Trials and Scrambles	67-6017	Rear wheel spokes (nearside)	20
23	350c.c. 500c.c.	15-5290	Rear hub grease nipple	1
24	350c.c. 500c.c.	67-6136	Rear hub shell complete with bearings	1
25	350c.c. 500c.c.	65-5883	Rear hub ball bearing	1
26	350c.c. 500c.c.	65-5887	Felt washer retaining ring	1
27	350c.c. 500c.c.	65-5886	Rear hub washer (felt)	1
28	350c.c. 500c.c.	67-6133	End cover	1
29	350c.c. 500c.c.	65 5890	Hub spindle distance collar	1
30	350c.c. 500c.c.	67 6028	Hub spindle distance sleeve	1
31	350c.c. 500c.c.	67-6016	Rear wheel spokes (offside)	20
32	350c.c. 500c.c.	67-6161	Rear hub spindle	1
33	350c.c. 500c.c.	67-6051	Hub shell washer (rubber)	1
34	350c.c. 500c.c.	67-6027	Hub spindle sleeve	1
35	350c.c. 500c.c.	65 5884	Hub bearing thrust washer	1
36	350c.c. 500c.c.	65-5883	Rear hub ball bearing	1
37	350c.c. 500c.c.	67-6038	Brake shell securing bolt	6
38	350c.c. 500c.c.	67-6031	Rear hub spindle nut	1
39	350c.c. 500c.c. Trials, Clubmans and Road Racing	42-6024	Rear brake drum and chainwheel (42T)	1
...	350c.c. 500c.c. Scrambles	42-6025	Rear brake drum and chainwheel (46T)	1
40	350c.c. 500c.c.	67-6039	Brake drum bolt locking strip	3
41	350c.c. 500c.c.	3-720	Rear wheel securing bolt	6
42	350c.c. 500c.c.	65-5904	Rear brake spring	2
43	350c.c. 500c.c.	65-5901	Rear brake shoe complete	2
44	350c.c. 500c.c.	42-6033	Rear brake fulcrum pin	1
45	350c.c. 500c.c.	67-6032	Rear hub collar	1
46	350c.c. 500c.c.	42-6030	Rear brake cover plate complete with fixed fittings	1
47	350c.c. 500c.c.	65-5411	Rear brake fulcrum pin washer (spring)	1
48	350c.c. 500c.c.	24-7000	Rear brake fulcrum pin nut	1
49	350c.c. 500c.c.	67-6046	Rear brake outrigger strap	1
50	350c.c. 500c.c.	42-6046	Brake pedal return spring	1
51	350c.c. 500c.c.	42-6045	Rear brake operating lever	1

REAR HUB and WHEEL FITTINGS

350c.c. and 500c.c. Gold Star (Swinging Arm)

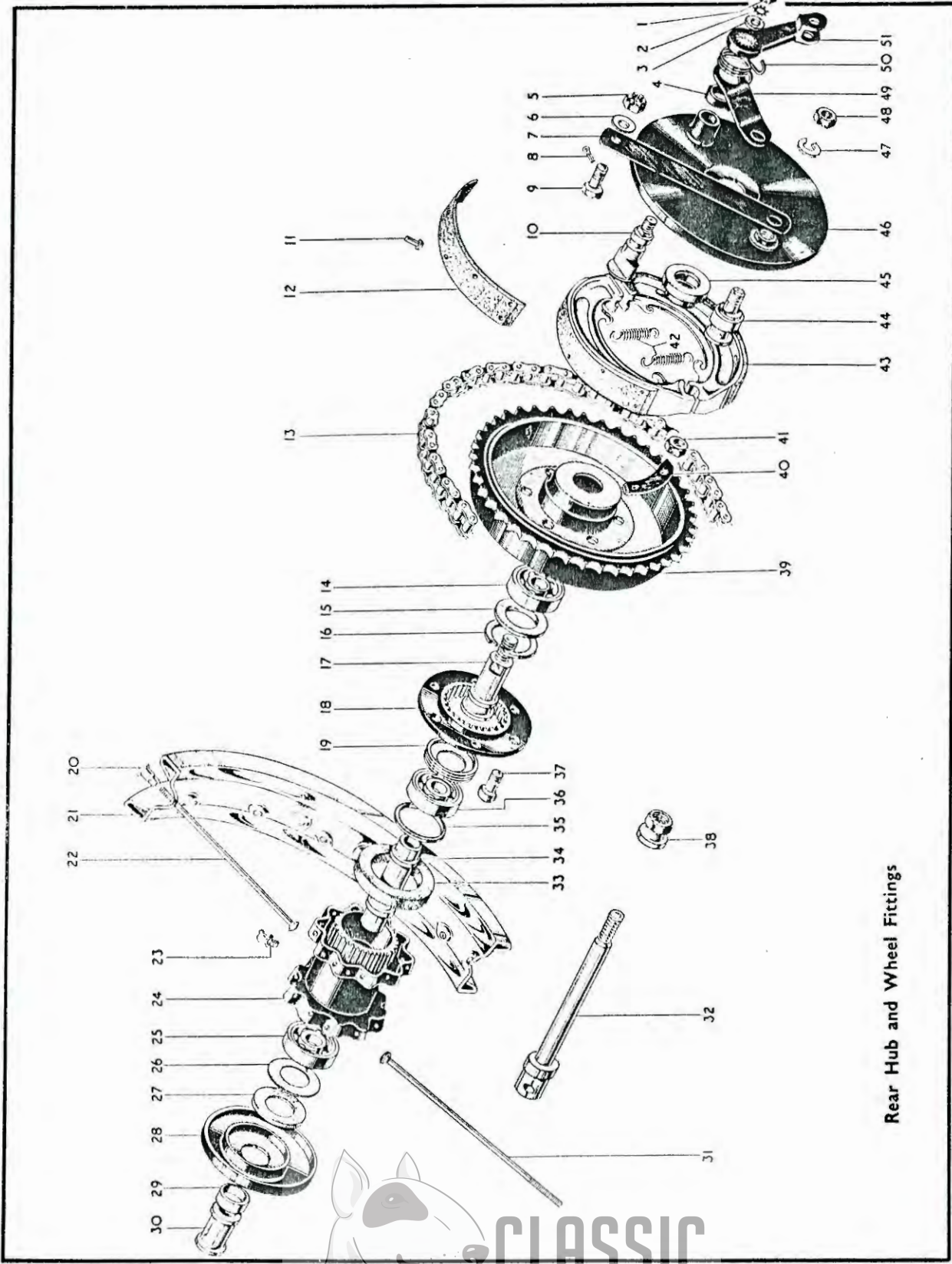

Rear Hub and Wheel Fittings

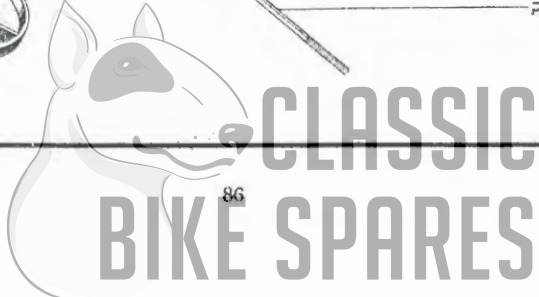

TOOLS, EQUIPMENT and SUNDRIES

350c.c. and 500c.c. Gold Star. (Swinging Arm).
As 1952 Gold Star Clubmans except the following:
(These items are not illustrated)

Models.	Part No.	Description.	Number per set.
350c.c. 500c.c. ...	42-9031 ...	Petrol tank fixing bolt spanner ...	1
350c.c. 500c.c. ...	24-8957 ...	Petrol tank fixing bolt tommy bar ...	1
350c.c. 500c.c. ...	24-8716 ...	Transmission chain (front) (Trials and Scrambles) ...	1
350c.c. ...	24-8930 ...	Transmission chain (front) (Clubmans and Road Racing) ...	1
500c.c. ...	24-8931 ...	Transmission chain (front) (Clubmans and Road Racing) ...	1
350c.c. 500c.c. ...	66-9160 ...	Transmission chain (rear) (Clubmans and Road Racing) ...	1
350c.c. 500c.c. ...	66-9162 ...	Transmission chain (rear) (Trials and Scrambles) ...	1
EQUIPMENT.			
350c.c. 500c.c. ...	19-2107 ...	Speedometer (Clubmans and Road Racing) (3.50" x 19" or 3.25" x 19" rear tyre)	1
350c.c. 500c.c. ...	19-2106 ...	Speedometer (Trials) (4.00" x 19" rear tyre) ...	1
350c.c. 500c.c. ...	67-9057 ...	Speedometer cable ...	1
350c.c. 500c.c. ...	65-9179 ...	Speedometer bracket bolt ...	2
350c.c. 500c.c. ...	15-7383 ...	Speedometer mounting rubber ...	4
350c.c. 500c.c. ...	27-8560 ...	Speedometer mounting washer ...	4
350c.c. 500c.c. ...	65-9160 ...	Speedometer cable (when rev counter and speedo is fitted) ...	1
SUNDRIES.			
350c.c. 500c.c. ...	42-9026 ...	Inflator ...	1
350c.c. 500c.c. ...	19-1114 ...	Stop lamp switch ...	1
350c.c. 500c.c. ...	42-9027 ...	Stop lamp switch operating link ...	1
350c.c. 500c.c. ...	42-4085 ...	Stop lamp switch plate ...	1

Plate 28

ACCESSORIES

350c.c. and 500c.c. Gold Star (Swinging Arm)

Plate Ref. Number.	Models.	Part No.	Description.	Number per set.
1	350c.c. 500c.c. ... Gold Star Trials and Scrambles	42-6759 ...	Rear mudguard front fixing clip (bottom) ...	1
2	350c.c. 500c.c. ... Gold Star Trials and Scrambles	42-6766 ...	Rear mudguard with fixed fittings ...	1
3	350c.c. 500c.c. ... Gold Star Trials and Scrambles	42-6782 ...	Rear mudguard stiffening plate ...	2
4	350c.c. 500c.c. ... Gold Star Trials and Scrambles	27-8560 ...	Rear mudguard fixing clip bolt washer (plain) ...	4
5	350c.c. 500c.c. ... Gold Star Trials and Scrambles	2-2273 ...	Rear mudguard fixing clip bolt ...	4
6	350c.c. 500c.c. ... Gold Star Trials and Scrambles	42-6784 ...	Rear mudguard bridge (top) ...	1
7	350c.c. 500c.c. ... Gold Star Trials and Scrambles	42-6784 ...	Rear mudguard bridge (bottom) ...	1
8	350c.c. 500c.c. ... Gold Star Clubmans and Road Racing Trials and Scrambles	42-9061 ...	Twin seat rear fixing bolt ...	2
9	350c.c. 500c.c. ... Gold Star Clubmans and Road Racing Trials and Scrambles	2-923 ...	Twin seat rear fixing bolt washer (plain) ...	2
10	350c.c. 500c.c. ... Gold Star Clubmans and Road Racing Trials and Scrambles	35-33 ...	Twin seat rear fixing bolt washer (spring) ...	2

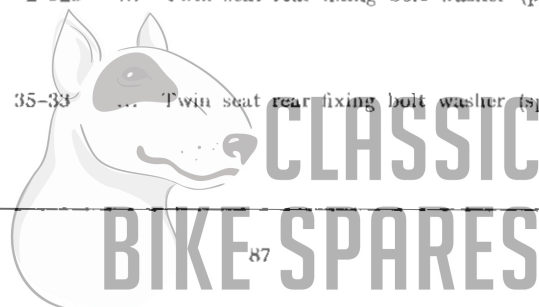

Plate 28—continued

ACCESSORIES—continued.
350c.c. and 500c.c. Gold Star (Swinging Arm)

Plate Ref. Number.	Models.	Part No.	Description.	Number per set.
11	350c.c. 500c.c. Gold Star Clubmans and Road Racing Trials and Scrambles	24-563	Twin seat rear support bracket and mudguard bolt nut	2
12	350c.c. 500c.c. Gold Star Clubmans and Road Racing Trials and Scrambles	36-382	Twin seat rear support bracket and mudguard bolt washer (shake-proof)	2
13	350c.c. 500c.c. Gold Star Clubmans and Road Racing Trials and Scrambles	42-9059	Twin seat rear support bracket	1
14	350c.c. 500c.c. Gold Star Clubmans and Road Racing Trials and Scrambles	2-923	Twin seat rear support bracket and mudguard bolt washer (plain)	2
15	350c.c. 500c.c. Gold Star Clubmans and Road Racing Trials and Scrambles	15-7354	Twin seat rear support bracket and mudguard bolt	2
16	350c.c. 500c.c. Gold Star Clubmans and Road Racing Trials and Scrambles	42-9050	Twin seat complete with brackets	1
17	350c.c. 500c.c. Gold Star Clubmans and Road Racing Trials and Scrambles	42-9057	Twin seat support rubber	2
18	350c.c. 500c.c. Gold Star Clubmans and Road Racing Trials and Scrambles	28-2338	Twin seat front support bracket fixing bolt	2
19	350c.c. 500c.c. Gold Star Clubmans and Road Racing Trials and Scrambles	2-923	Twin seat front support bracket fixing bolt washer (plain)	2
20	350c.c. 500c.c. Gold Star Clubmans and Road Racing Trials and Scrambles	35-33	Twin seat front support bracket fixing bolt washer (spring)	2
21	350c.c. 500c.c. Gold Star Clubmans and Road Racing Trials and Scrambles	42-9058	Twin seat front support bracket	1
22	350c.c. 500c.c. Gold Star Clubmans and Road Racing Trials and Scrambles	2-220	Twin seat front support pin securing pin	1
23	350c.c. 500c.c. Gold Star Clubmans and Road Racing Trials and Scrambles	42-9060	Twin seat front support pin	1
24	350c.c. 500c.c. Gold Star Clubmans and Road Racing Trials and Scrambles	42-8012	Petrol tank mounting rubber (top)	1



Plate 28—continued.

ACCESSORIES—continued.
350c.c. and 500c.c. Gold Star (Swinging Arm).

Plate Ref. Number.	Models.	Part No.	Description.	Number per set.
25	350c.c. 500c.c. Gold Star Clubmans and Road Racing Trials and Scrambles	2-1945	Petrol tank fixing bolt washer (plain)	1
26	350c.c. 500c.c. Gold Star Clubmans and Road Racing Trials and Scrambles	35-707	Petrol tank filler cap split pin	1
27	350c.c. 500c.c. Gold Star Clubmans and Road Racing Trials and Scrambles	66-8351	Petrol tank filler cap	1
28	350c.c. 500c.c. Gold Star Trials and Scrambles	65-8675	Front brake cable and cover complete (7" brake)	1
—	350c.c. 500c.c. Gold Star Clubmans and Road Racing	67-8610	Front brake cable and cover complete (8" brake)	1
29	350c.c. 500c.c. Gold Star Clubmans and Road Racing Trials and Scrambles	42-8011	Petrol tank fixing bolt	1
30	350c.c. 500c.c. Gold Star Clubmans and Road Racing Trials and Scrambles	42-8010	Petrol tank rubber grommet	1
31	350c.c. 500c.c. Gold Star Clubmans and Road Racing Trials and Scrambles	29-8810	Front brake control complete (less cable and cover)	1
32	350c.c. 500c.c. Gold Star Clubmans and Road Racing Trials and Scrambles	65-8501	Throttle twist grip complete (less cable and cover)	1
33	350c.c. 500c.c. Gold Star Clubmans and Road Racing Trials and Scrambles	66-8896	Air control complete (less cable and cover)	1
34	350c.c. 500c.c. Gold Star Clubmans and Road Racing, Scrambles	65-8823	Throttle twist grip cable and cover complete	1
35	350c.c. 500c.c. Gold Star Clubmans and Road Racing, Trials and Scrambles	65-8832	Throttle twist grip cable and cover complete	1
35	350c.c. 500c.c. Gold Star Clubmans and Road Racing, Trials and Scrambles	65-8836	Air control cable and cover complete	1
36	350c.c. 500c.c. Gold Star Clubmans and Road Racing	42-4966	Handlebar (less controls)	1
—	350c.c. 500c.c. Gold Star Trials and Scrambles	65-4960	Handlebar (less controls)	1
37	350c.c. 500c.c. Gold Star Clubmans and Road Racing, Trials and Scrambles	65-8714	Ignition control cable and cover complete	1
38	350c.c. 500c.c. Gold Star Clubmans and Road Racing Trials and Scrambles	66-8810	Ignition control lever complete (less cable and cover)	1
39	350c.c. 500c.c. Gold Star Clubmans and Road Racing Trials and Scrambles	65-8502	Dummy grip (for left-hand bar)	1

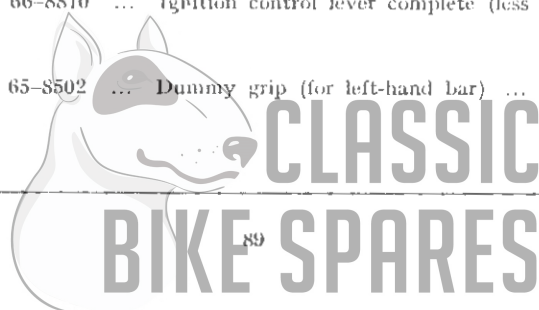

ACCESSORIES—continued.
350c.c. and 500c.c. Gold Star (Swinging Arm)

Plate Ref. Number.	Models.	Part No.	Description.	Number per set.
40	350c.c. 500c.c. ... Gold Star, Clubmans and Road Racing Trials and Scrambles	29-8820	Clutch control complete (less cable and cover) ...	1
41	350c.c. 500c.c. ... Gold Star, Clubmans and Road Racing Trials and Scrambles	66-8513	Exhaust lifter control complete (less cable and cover)	1
42	350c.c. 500c.c., Clubmans and Road Racing Trials and Scrambles	42-8601	Exhaust lifter cable and cover complete	1
43	350c.c. 500c.c., Gold Star Clubmans and Road Racing and Trials and Scrambles	65-8680	Clutch control cable and cover complete	1
44	350c.c. 500c.c. ... Gold Star Clubmans and Road Racing Trials and Scrambles	27-8346	Petrol tank breather pipe union screw	1
45	350c.c. 500c.c. ... Gold Star Clubmans and Road Racing Trials and Scrambles	65-8362	Petrol tank breather pipe complete	1
46	350c.c. 500c.c. ... Gold Star Clubmans and Road Racing	42-8007	Petrol tank (4½ gallons)	1
—	350c.c. 500c.c. ... Gold Star Clubmans and Road Racing	42-8007	Petrol tank (4½ gallons) (when alcohol is used)	1
—	350c.c. 500c.c. ... Gold Star Trials and Scrambles	42-8006	Petrol tank (2 gallons)	1
—	350c.c. 500c.c. ... Gold Star Trials and Scrambles	42-8006	Petrol tank (2 gallons) (when alcohol is used)	1
47	350c.c. 500c.c. ... Gold Star Clubmans and Road Racing	42-8034	Petrol tank badge clip screw nut	4
48	350c.c. 500c.c. ... Gold Star Clubmans and Road Racing	65-8217	Petrol tank badge clip screw washer (leather)	4
49	350c.c. 500c.c. ... Gold Star Clubmans and Road Racing	42-8020	Petrol tank badge clip	2
50	350c.c. 500c.c. ... Gold Star Clubmans and Road Racing	65-8193	Petrol tank badge	2
51	350c.c. 500c.c. ... Gold Star Clubmans and Road Racing	65-8317	Petrol tank badge clip screw	4
52	350c.c. 500c.c. ... Gold Star Trials and Scrambles	65-8211	Petrol tank badge	2
53	350c.c. 500c.c. ... Gold Star Trials and Scrambles	89-8012	Petrol tank badge retaining spring	2
54	350c.c. 500c.c. ... Gold Star, Clubmans and Road Racing Trials and Scrambles	42-8014	Petrol tank mounting rubber (top tube)	2
55	350c.c. 500c.c. ... Gold Star, Clubmans and Road Racing Trials and Scrambles	42-8013	Petrol tank mounting rubber (side)	2



ACCESSORIES

350c.c. and 500c.c. Gold Star (Swinging Arm)

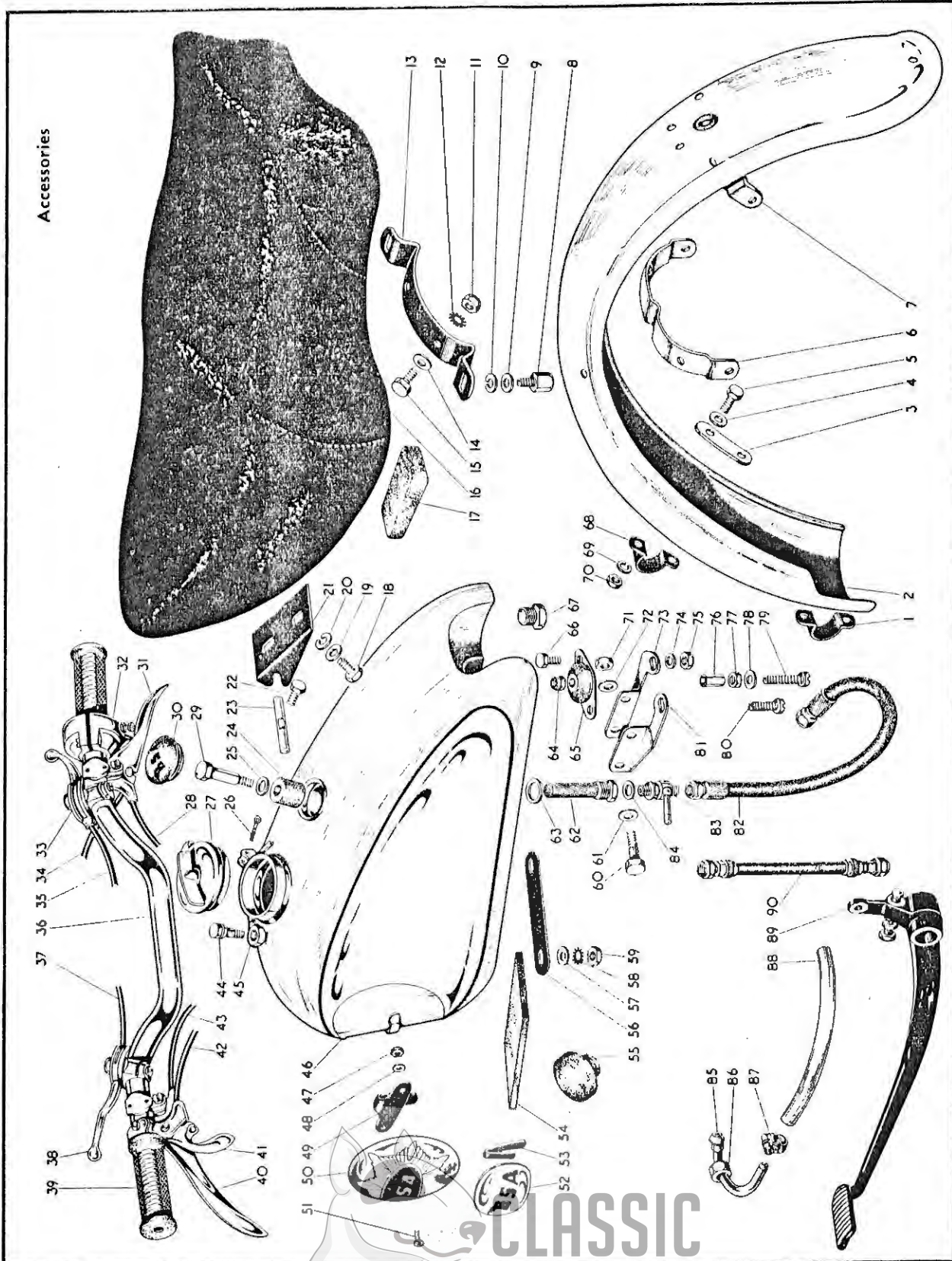

CLASSIC
BIKE SPARES

Plate Ref. Number.	Models.	Part No.	Description.	Number per set.
56	350c.c. 500c.c. Gold Star Clubmans and Road Racing Trials and Scrambles	67-8085	Petrol tank stiffening plate...	1
57	350c.c. 500c.c. Gold Star Clubmans and Road Racing Trials and Scrambles	2-923	Petrol tank stiffening plate stud washer (plain)	2
58	350c.c. 500c.c. Gold Star Clubmans and Road Racing Trials and Scrambles	36-382	Petrol tank stiffening plate stud washer (shakeproof)	2
59	350c.c. 500c.c. Gold Star Clubmans and Road Racing Trials and Scrambles	2-49	Petrol tank stiffening plate stud nut	2
60	350c.c. Gold Star Clubmans and Road Racing	3-1156	Float chamber mounting bracket fixing bolt	2
60	500c.c. Gold Star Clubmans and Road Racing	32-194	Float chamber mounting fixing bolt	2
61	500c.c. Gold Star Clubmans and Road Racing	2-370	Float chamber mounting bracket fixing bolt washer (plain)	2
62	350c.c. 500c.c. Gold Star Clubmans and Road Racing Trials and Scrambles	27-8443	Petrol tank filter complete	2
63	350c.c. 500c.c. Gold Star Clubmans and Road Racing Trials and Scrambles	24-8504	Petrol tank filter washer (fibre)	2
64	350c.c. 500c.c. Gold Star Clubmans and Road Racing	29-8814	Float chamber flexible mounting bolt nut (top) (Simmonds)	1
65	350c.c. 500c.c. Gold Star Clubmans and Road Racing Trials and Scrambles	42-8033	Float chamber flexible mounting	1
66	350c.c. 500c.c. Gold Star Clubmans and Road Racing Trials and Scrambles	1-4606	Float chamber flexible mounting bolt	2
67	350c.c. 500c.c. Gold Star Trials and Scrambles	65-8184	Petrol tap socket plug (for use when single petrol tap is fitted)	1
68	350c.c. 500c.c. Gold Star Trials and Scrambles	42-6785	Rear mudguard fixing clip	1
69	350c.c. 500c.c. Gold Star Trials and Scrambles	2-1462	Rear mudguard fixing clip bolt washer (spring)	4
70	350c.c. 500c.c. Gold Star Trials and Scrambles	2-2395	Rear mudguard fixing clip bolt nut	4
71	350c.c. 500c.c. Gold Star Clubmans and Road Racing	2-49	Float chamber mounting bracket fixing bolt nut	2

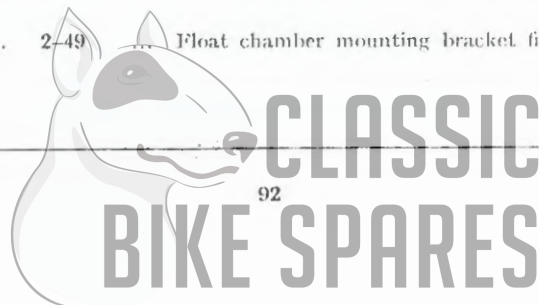

Plate 28—continued.

ACCESSORIES—continued.
350c.c. and 500c.c. Gold Star (Swinging Arm).

Plate Ref. Number.	Models.	Part No.	Description.	Number per set.
72	350c.c. Gold Star Clubmans and Road Racing	2-370	Float chamber mounting bracket fixing bolt washer (plain)	2
73	350c.c. 500c.c. Gold Star Clubmans and Road Racing Trials and Scrambles	42-8032	Float chamber mounting bracket (right-hand)	1
74	350c.c. 500c.c. Gold Star Clubmans and Road Racing Trials and Scrambles	1-4621	Float chamber flexible mounting bolt washer (plain)	2
75	350c.c. 500c.c. Gold Star Clubmans and Road Racing Trials and Scrambles	25-7151	Float chamber flexible mounting bolt nut	2
76	500c.c. Gold Star Clubmans and Road Racing	42-8035	Float chamber flexible mounting distance piece	1
77	350c.c. 500c.c. Gold Star Clubmans and Road Racing	2-443	Float chamber flexible mounting locknut (bottom)	1
78	350c.c. 500c.c. Gold Star Clubmans and Road Racing	66-7518	Float chamber flexible mounting bolt washer (fibre)	1
79	500c.c. Gold Star Clubmans and Road Racing	21-6194	Float chamber flexible mounting bolt	1
80	350c.c. Gold Star Clubmans and Road Racing	21-6187	Float chamber flexible mounting bolt	1
81	350c.c. 500c.c. Gold Star Clubmans and Road Racing Trials and Scrambles	42-8031	Float chamber mounting bracket (left-hand)	1
82	350c.c. 500c.c. Gold Star Clubmans and Road Racing Trials and Scrambles	42-8022	Flexible petrol pipe (rubber)	2
83	350c.c. 500c.c. Gold Star Clubmans and Road Racing Trials and Scrambles	65-8171	Petrol tap	2
84	350c.c. 500c.c. Gold Star Clubmans and Road Racing Trials and Scrambles	2-930	Petrol tap washer (fibre)	2
85	350c.c. 500c.c. Gold Star Clubmans and Road Racing Trials and Scrambles	42-8025	Copper petrol pipe complete	1
86	350c.c. 500c.c. Gold Star Clubmans and Road Racing Trials and Scrambles	66-8332	Copper petrol pipe nut	1



Plate 28—continued.

ACCESSORIES—continued.
350c.c. and 500c.c. Gold Star (Swinging Arm)

Plate Ref. Number.	Models.	Part No.	Description.	Number per set.
87	350c.c. 500c.c. Gold Star Clubmans and Road Racing Trials and Scrambles	42-8024	Petrol pipe hose clip	2
88	350c.c. 500c.c. Gold Star Clubmans and Road Racing Trials and Scrambles	42-8023	Flexible petrol pipe (plastic)	1
89	350c.c. 500c.c. Gold Star Trials and Scrambles	42-7003	Rear brake pedal complete (with adjuster screw, nut and washer)	1
90	350c.c. 500c.c. Gold Star Trials and Scrambles	65-8172	Flexible petrol pipe (rubber) (for use with single bottom feed carburetter).	1
—	350c.c. 500c.c. Gold Star Trials and Scrambles	65-8173	Flexible petrol pipe (rubber) (for use with twin feed carburetter)	1

Plate 29

ACCESSORIES
350c.c. and 500c.c. Gold Star (Swinging Arm)

Plate Ref. Number.	Model.	Part No.	Description.	Number per set.
1	350c.c. 500c.c. Gold Star Clubmans and Road Racing Trials and Scrambles	42-7701	Rear chainguard	1
2	350c.c. 500c.c. Gold Star Clubmans and Road Racing Trials and Scrambles	65-292	Chainguard fixing bolt	1
3	350c.c. 500c.c. Gold Star Clubmans and Road Racing Trials and Scrambles	2-923	Chainguard fixing bolt washer (plain)	1
4	350c.c. 500c.c. Gold Star Clubmans and Road Racing Trials and Scrambles	30-1194	Chainguard fixing bolt distance piece	1
5	350c.c. 500c.c. Gold Star Clubmans and Road Racing Trials and Scrambles	2-833	Chainguard fixing bolt nut	1
6	350c.c. 500c.c. Gold Star Clubmans and Road Racing Trials and Scrambles	24-8784	Chainguard fixing bolt washer (spring)	1
7	350c.c. 500c.c. Gold Star Clubmans and Road Racing Trials and Scrambles	2-833	Chainguard fixing bolt nut	1
8	350c.c. 500c.c. Gold Star Clubmans and Road Racing Trials and Scrambles	24-8784	Chainguard fixing bolt washer (spring)	1

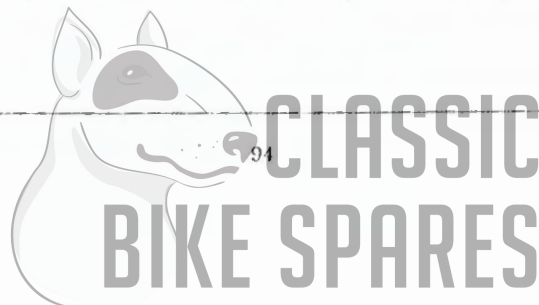

CLASSIC
 BIKE SPARES

Plate 29—continued.

ACCESSORIES—continued.
350c.c. and 500c.c. Gold Star (Swinging Arm)

Plate Ref. Number.	Models.	Part No.	Description.	Number per set.
9	350c.c. 500c.c. Gold Star Clubmans and Road Racing Trials and Scrambles	2-353	Rear chainguard fixing bolt (short)	2
10	350c.c. 500c.c. Gold Star Clubmans and Road Racing Trials and Scrambles	24-8784	Rear chainguard fixing bolt washer (spring)	2
11	350c.c. 500c.c. Gold Star Clubmans and Road Racing Trials and Scrambles	2-46	Rear brake pedal fulcrum pin nut	1
12	350c.c. 500c.c. Gold Star Clubmans and Road Racing Trials and Scrambles	42-7010	Rear brake pedal fulcrum pin tab washer	1
13	350c.c. 500c.c. Gold Star Clubmans and Road Racing Trials and Scrambles	42-7009	Rear brake pedal fulcrum pin	1
14	350c.c. 500c.c. Gold Star Clubmans and Road Racing	42-7005	Rear brake pedal complete (with adjuster, screw, nut and washer)	1
15	350c.c. 500c.c. Gold Star Clubmans and Road Racing Trials and Scrambles	67-4032	Rear brake pedal stud	1
16	350c.c. 500c.c. Gold Star Clubmans and Road Racing Trials and Scrambles	42-7007	Rear brake rod complete	1
17	350c.c. 500c.c. Gold Star Clubmans and Road Racing Trials and Scrambles	2-46	Rear brake pedal fulcrum pin nut	1
18	350c.c. 500c.c. Gold Star Clubmans and Road Racing Trials and Scrambles	2-522	Rear brake pedal washer (spring)	1
19	350c.c. 500c.c. Gold Star Clubmans and Road Racing Trials and Scrambles	30-196	Rear brake pedal stud washer (plain)	1
20	350c.c. 500c.c. Gold Star Clubmans and Road Racing Trials and Scrambles	2-510	Rear brake rod toggle end screw	1
21	350c.c. 500c.c. Gold Star Clubmans and Road Racing Trials and Scrambles	2-443	Rear brake rod toggle end screw nut	1
22	350c.c. 500c.c. Gold Star Clubmans and Road Racing Trials and Scrambles	15-7354	Front mudguard stay bolt	4
—	350c.c. 500c.c. Gold Star Clubmans and Road Racing Trials and Scrambles	15-7354	Front mudguard stay bolt (when front stand is fitted)	2

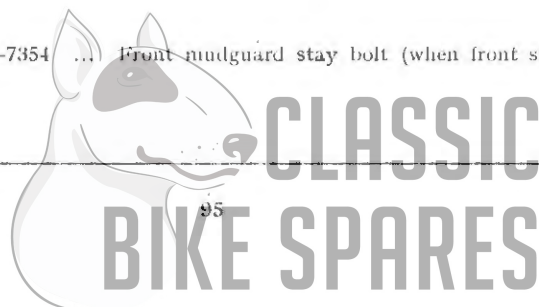

Plate Ref. Number.	Models.	Part No.	Description.	Number per set.
23	350c.c. 500c.c. Gold Star Clubmans and Road Racing Trials and Scrambles	2-923	Front mudguard stay bolt washer (plain)	4
—	350c.c. 500c.c. Gold Star Clubmans and Road Racing Trials and Scrambles	2-923	Front mudguard stay bolt washer (plain) (when front stand is fitted).	2
24	350c.c. 500c.c. Gold Star Clubmans and Road Racing Trials and Scrambles	2-1934	Front stand securing bolt	2
25	350c.c. 500c.c. Gold Star Clubmans and Road Racing Trials and Scrambles	2-923	Front stand securing bolt washer (plain)	2
26	350c.c. 500c.c. Gold Star Clubmans and Road Racing Trials and Scrambles	42-6513	Front stand (19" wheel)	1
—	350c.c. 500c.c. Gold Star Clubmans and Road Racing Trials and Scrambles	67-6558	Front stand (21" wheel)	1
27	350c.c. 500c.c. Gold Star Clubmans and Road Racing Trials and Scrambles	24-8784	Front stand securing bolt washer (spring)	2
28	350c.c. 500c.c. Gold Star Clubmans and Road Racing Trials and Scrambles	2-1616	Front stand securing bolt nut	2
29	350c.c. 500c.c. Gold Star Clubmans and Road Racing Trials and Scrambles	2-14	Front stand release bolt	1
30	350c.c. 500c.c. Gold Star Clubmans and Road Racing Trials and Scrambles	2-2580	Front stand release bolt washer	1
31	350c.c. 500c.c. Gold Star Clubmans and Road Racing Trials and Scrambles	2-1616	Front mudguard stay bolt nut	4
—	350c.c. 500c.c. Gold Star Clubmans and Road Racing Trials and Scrambles	2-1616	Front mudguard stay bolt nut (when front stand is fitted)	2
32	350c.c. 500c.c. Gold Star Clubmans and Road Racing Trials and Scrambles	24-8784	Front mudguard stay bolt washer (spring)	4
—	350c.c. 500c.c. Gold Star Clubmans and Road Racing Trials and Scrambles	24-8784	Front mudguard stay bolt washer (spring) (when front stand is fitted).	2
33	350c.c. 500c.c. Gold Star Clubmans and Road Racing Trials and Scrambles	15-480	Front mudguard centre stay bolt (offside)...	2



Plate 29—continued.

ACCESSORIES—continued.
350c.c. and 500c.c. Gold Star (Swinging Arm)

Plate Ref. Number.	Models.	Part No.	Description.	Number per set.
34	350c.c. 500c.c. Gold Star Clubmans and Road Racing Trials and Scrambles	36-382	Front mudguard centre stay bolt washer (shakeproof)	4
35	350c.c. 500c.c. Gold Star Clubmans and Road Racing Trials and Scrambles	2-49	Front mudguard centre stay bolt nut	4
36	350c.c. 500c.c. Gold Star Clubmans and Road Racing Trials and Scrambles	2-2395	Front mudguard centre stay fixing screw nut	2
37	350c.c. 500c.c. Gold Star Clubmans and Road Racing Trials and Scrambles	2-1462	Front mudguard centre stay fixing screw washer (spring)	2
38	350c.c. 500c.c. Gold Star Clubmans and Road Racing Trials and Scrambles	42-6511	Front mudguard centre stay (19" wheel)	1
—	350c.c. 500c.c. Gold Star Clubmans and Road Racing Trials and Scrambles	42-6505	Front mudguard centre stay (21" wheel)	1
39	350c.c. 500c.c. Gold Star Clubmans and Road Racing Trials and Scrambles	2-2395	Front mudguard stay fixing screw nut	4
—	350c.c. 500c.c. Gold Star Clubmans and Road Racing Trials and Scrambles	2-2395	Front mudguard stay fixing screw nut (when front stand is fitted)	2
40	350c.c. 500c.c. Gold Star Clubmans and Road Racing Trials and Scrambles	2-1462	Front mudguard stay fixing screw washer (spring)	4
—	350c.c. 500c.c. Gold Star Clubmans and Road Racing Trials and Scrambles	2-1462	Front mudguard stay fixing screw washer (spring) (when front stand is fitted).	2
41	350c.c. 500c.c. Gold Star Clubmans and Road Racing Trials and Scrambles	2-2395	Front number plate fixing stud nut	2
42	350c.c. 500c.c. Gold Star Clubmans and Road Racing Trials and Scrambles	2-1462	Front number plate fixing stud washer (spring)	2
43	350c.c. 500c.c. Gold Star Clubmans and Road Racing Trials and Scrambles	42-6510	Front mudguard stay (19" wheel)	2
—	350c.c. 500c.c. Gold Star Clubmans and Road Racing Trials and Scrambles	42-6510	Front mudguard stay (19" wheel) (when front stand is fitted)...	1
—	350c.c. 500c.c. Gold Star Clubmans and Road Racing Trials and Scrambles	65-6612	Front mudguard stay (21" wheel)	2
—	350c.c. 500c.c. Gold Star Clubmans and Road Racing Trials and Scrambles	65-6612	Front mudguard stay (21" wheel) (when front stand is fitted)...	1



Plate Ref. Number.	Models.	Part No.	Description.	Number per set.
44	350c.c. 500c.c. Gold Star Clubmans and Road Racing	42-6509/3	Front mudguard with fixed fittings (19" wheel)	1
—	350c.c. 500c.c. Gold Star Trials and Scrambles	42-6503/3	Front mudguard with fixed fittings (21" wheel)	1
45	350c.c. 500c.c. Gold Star Clubmans and Road Racing	27-8560	Front mudguard stay fixing screw washer (plain)	4
—	350c.c. 500c.c. Gold Star Clubmans and Road Racing	27-8560	Front mudguard stay fixing screw washer (plain) (when front stand is fitted).	2
46	350c.c. 500c.c. Gold Star Clubmans and Road Racing	65-6576	Front number plate complete	1
47	350c.c. 500c.c. Gold Star Clubmans and Road Racing	15-7161	Front mudguard stay fixing screw	4
—	350c.c. 500c.c. Gold Star Clubmans and Road Racing	15-7161	Front mudguard stay fixing screw (when front stand is fitted)	2
48	350c.c. 500c.c. Gold Star Clubmans and Road Racing	42-8348	Oil tank filler cap	1
49	350c.c. 500c.c. Gold Star Clubmans and Road Racing	35-707	Oil tank filler cap split pin...	1
50	350c.c. 500c.c. Gold Star Clubmans and Road Racing	42-8314	Oil tank with fixed fittings	1
51	350c.c. 500c.c. Gold Star Clubmans and Road Racing	27-8560	Front mudguard centre stay fixing screw washer (plain)	2
52	350c.c. 500c.c. Gold Star Clubmans and Road Racing	15-7161	Front mudguard centre stay fixing screw	2
53	350c.c. 500c.c. Gold Star Clubmans and Road Racing	29-5289	Oil tank top fixing bolt	1
54	350c.c. 500c.c. Gold Star Clubmans and Road Racing	2-537	Oil tank top fixing bolt washer (plain)	1
55	350c.c. 500c.c. Gold Star Clubmans and Road Racing	42-8339	Oil tank top fixing spacing tube	1

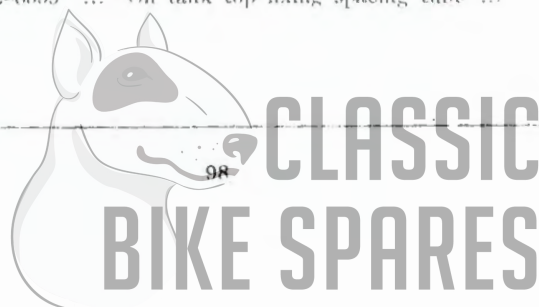

Plate 29—continued.

ACCESSORIES—continued.
350c.c. and 500c.c. Gold Star (Swinging Arm)

Plate Ref. Number.	Models.	Part No.	Description.	Number per set.
56	350c.c. 500c.c. Gold Star Clubmans and Road Racing Trials and Scrambles	42 8343	Oil tank filter plug washer (fibre)	1
57	350c.c. 500c.c. Gold Star Clubmans and Road Racing Trials and Scrambles	42 8334	Oil tank filter assembly	1
58	350c.c. 500c.c. Gold Star Clubmans and Road Racing Trials and Scrambles	3-1156	Front mudguard centre stay bolt (neatside)	2
59	350c.c. 500c.c. Gold Star Clubmans and Road Racing Trials and Scrambles	42-8344	Oil feed pipe complete	1
60	350c.c. 500c.c. Gold Star Clubmans and Road Racing Trials and Scrambles	2 6537	Front stand release bolt washer (plain)	1
61	350c.c. 500c.c. Gold Star Clubmans and Road Racing Trials and Scrambles	2 51	Front stand release bolt locknut	1
62	350c.c. 500c.c. Gold Star Clubmans and Road Racing Trials and Scrambles	15-447	Front stand release bolt nut	1
63	350c.c. 500c.c. Gold Star Clubmans and Road Racing Trials and Scrambles	2-49	Rear mudguard bottom bracket frame bolt nut	2
64	350c.c. 500c.c. Gold Star Clubmans and Road Racing Trials and Scrambles	24-8784	Rear mudguard bottom bracket front bolt washer (spring)	2
65	350c.c. 500c.c. Gold Star Clubmans and Road Racing Trials and Scrambles	42 6758	Rear mudguard bottom bracket	1
66	350c.c. 500c.c. Gold Star Clubmans and Road Racing Trials and Scrambles	24-7148	Rear mudguard bottom bracket fixing bolt	2
67	350c.c. 500c.c. Gold Star Clubmans and Road Racing Trials and Scrambles	15 7354	Rear mudguard bottom bracket frame bolt	2
68	350c.c. 500c.c. Gold Star Clubmans and Road Racing Trials and Scrambles	42 6759	Rear mudguard fixing clip	1
69	350c.c. 500c.c. Gold Star Clubmans and Road Racing Trials and Scrambles	2-2273	Rear mudguard fixing clip bolt	2
70	350c.c. 500c.c. Gold Star Clubmans and Road Racing Trials and Scrambles	24 6770	Rear mudguard stay front fixing bolt	4
71	350c.c. 500c.c. Gold Star Clubmans and Road Racing Trials and Scrambles	2-923	Rear mudguard stay front fixing bolt washer (plain)	4



Plate 29—continued.

ACCESSORIES—continued.
350c.c. and 500c.c. Gold Star (Swinging Arm)

Plate Ref. Number.	Models.	Part No.	Description.	Number per set.
72	350c.c. 500c.c. Gold Star Clubmans and Road Racing Trials and Scrambles	27-8560	Rear mudguard top bridge fixing screw washer (plain) (when saddle is fitted).	2
73	350c.c. 500c.c. Gold Star Clubmans and Road Racing Trials and Scrambles	15-7161	Rear mudguard top bridge fixing screw (when saddle is fitted)	2
74	350c.c. 500c.c. Gold Star Clubmans and Road Racing Trials and Scrambles	42-8340	Rocker feed pipe banjo locknut	1
75	350c.c. 500c.c. Gold Star Clubmans and Road Racing Trials and Scrambles	15-203	Rocker feed pipe banjo washer (fibre)	2
76	350c.c. 500c.c. Gold Star Clubmans and Road Racing Trials and Scrambles	42-8342	Oil tank mounting strip (rubber)	2
77	350c.c. 500c.c. Gold Star Clubmans and Road Racing Trials and Scrambles	42-8331	Oil tank top fixing bolt spacing tube	1
78	350c.c. 500c.c. Gold Star Clubmans and Road Racing Trials and Scrambles	42-8326	Oil tank front fixing bolt	1
79	350c.c. 500c.c. Gold Star Clubmans and Road Racing Trials and Scrambles	42-8329	Oil tank front fixing bolt saddle washer	1
80	350c.c. 500c.c. Gold Star Clubmans and Road Racing Trials and Scrambles	42-8341	Oil tank top fixing bolt mounting pad (rubber)	2
81	350c.c. 500c.c. Gold Star Clubmans and Road Racing Trials and Scrambles	2-537	Oil tank top fixing bolt washer (plain)	1
82	350c.c. 500c.c. Gold Star Clubmans and Road Racing Trials and Scrambles	2-49	Oil tank top fixing bolt nut	1
83	350c.c. 500c.c. Gold Star Clubmans and Road Racing Trials and Scrambles	42-8341	Oil tank front fixing bolt mounting pad (rubber)	1
84	350c.c. 500c.c. Gold Star Clubmans and Road Racing Trials and Scrambles	2-537	Oil tank front fixing bolt washer (plain)	1
85	350c.c. 500c.c. Gold Star Clubmans and Road Racing Trials and Scrambles	2-49	Oil tank front fixing bolt nut	1

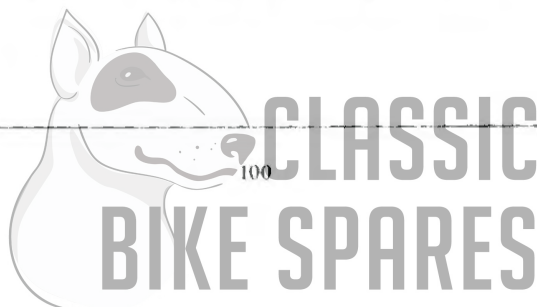

Plate 29—continued.

ACCESSORIES—continued.
350c.c. and 500c.c. Gold Star (Swinging Arm)

Plate Ref. Number.	Models.	Part No.	Description.	Number per set.
86	350c.c. 500c.c. Gold Star Clubmans and Road Racing Trials and Scrambles	42-8330	Oil tank front fixing bolt bracket cup	1
87	350c.c. 500c.c. Gold Star Clubmans and Road Racing Trials and Scrambles	42-8331	Oil tank front fixing bolt spacing tube	1
88	350c.c. 500c.c. Gold Star Clubmans and Road Racing Trials and Scrambles	42-8345	Oil return pipe complete	1
89	350c.c. 500c.c. Gold Star Clubmans and Road Racing Trials and Scrambles	90-6797	Rear number plate complete	1
90	350c.c. 500c.c. Gold Star Clubmans and Road Racing Trials and Scrambles	36-382	Rear mudguard stay front fixing bolt washer (shakeproof)	2
91	350c.c. 500c.c. Gold Star Clubmans and Road Racing Trials and Scrambles	2-49	Rear mudguard stay front fixing bolt nut	2
92	350c.c. 500c.c. Gold Star Clubmans and Road Racing Trials and Scrambles	15-7161	Rear number plate top fixing screw	2
93	350c.c. 500c.c. Gold Star Clubmans and Road Racing Trials and Scrambles	27-8560	Rear number plate top fixing screw washer (plain)	2
94	350c.c. 500c.c. Gold Star Clubmans and Road Racing Trials and Scrambles	15-7161	Rear mudguard rear bridge fixing screw	2
95	350c.c. 500c.c. Gold Star Clubmans and Road Racing Trials and Scrambles	27-8560	Rear mudguard rear bridge fixing screw washer (plain)	2
96	350c.c. 500c.c. Gold Star Clubmans and Road Racing Trials and Scrambles	2-49	Rear mudguard stay rear fixing bolt nut	2
97	350c.c. 500c.c. Gold Star Clubmans and Road Racing Trials and Scrambles	36-382	Rear mudguard stay rear fixing bolt washer (shakeproof)	2
98	350c.c. 500c.c. Gold Star Clubmans and Road Racing Trials and Scrambles	67-6839	Rear mudguard wiring grommet	2
99	350c.c. 500c.c. Gold Star Clubmans and Road Racing Trials and Scrambles	42-6751	Rear mudguard with fixed fittings	1
100	350c.c. 500c.c. Gold Star Clubmans and Road Racing Trials and Scrambles	15-7161	Rear number plate bottom fixing screw	1

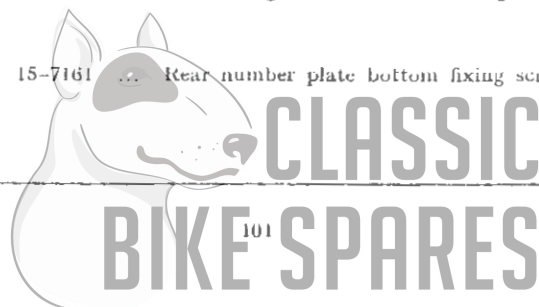

Plate 29—continued.

ACCESSORIES—continued.
350c.c. and 500c.c. Gold Star (Swinging Arm)

Plate Ref. Number.	Models.	Part No.	Description.	Number per set.
101	350c.c. 500c.c. Gold Star Clubmans and Road Racing Trials and Scrambles	27 8560	Rear number plate bottom fixing screw washer (plain)	1
102	350c.c. 500c.c. Gold Star Clubmans and Road Trim	2 522	Silencer bracket fixing bolt washer (spring)	1
103	350c.c. 500c.c. Gold Star Clubmans and Road Trim	2 449	Silencer bracket fixing bolt nut	1
104	350c.c. 500c.c. Gold Star Clubmans and Road Trim	2 803	Silencer bracket fixing bolt	1
105	350c.c. 500c.c. Gold Star Clubmans and Road Racing Trials and Scrambles	2 2395	Rear number plate bottom fixing bolt nut	1
106	350c.c. 450c.c. Gold Star Clubmans and Road Racing Trials and Scrambles	2 1462	Rear number plate bottom fixing bolt washer (spring)	1
107	350c.c. 500c.c. Gold Star Clubmans and Road Racing Trials and Scrambles	2-2395	Rear mudguard rear bridge fixing screw nut	2
108	350c.c. 500c.c. Gold Star Clubmans and Road Racing Trials and Scrambles	2-1462	Rear mudguard rear bridge fixing screw washer (spring)	2
109	350c.c. 500c.c. Gold Star Clubmans and Road Racing Trials and Scrambles	2 2395	Rear number plate top fixing screw nut	2
110	350c.c. 500c.c. Gold Star Clubmans and Road Racing Trials and Scrambles	2-1462	Rear number plate top fixing screw washer (spring)	2
111	350c.c. 500c.c. Gold Star Clubmans and Road Racing	42-6757	Rear mudguard rear bridge...	1
112	350c.c. 500c.c. Gold Star Clubmans and Road Racing	42 6757	Rear mudguard top bridge ...	1
113	350c.c. 500c.c. Gold Star Clubmans and Road Racing Trials and Scrambles	2-1462	Rear mudguard top bridge fixing screw washer (spring) (when saddle is fixed).	2
114	350c.c. 500c.c. Gold Star Clubmans and Road Racing Trials and Scrambles	2 2395	Rear mudguard top bridge fixing screw nut (when saddle is fitted)	2
115	350c.c. 500c.c. Gold Star Clubmans and Road Racing Trials and Scrambles	2 2395	Rear mudguard stay fixing bolt nut	4



Plate Ref. Number.	Models.	Part No.	Description.	Number per set.
116	350c.c. 500c.c. Gold Star Clubmans and Road Racing Trials and Scrambles	24-6770	Rear mudguard bracket bottom fixing bolt	2
117	350c.c. 500c.c. Gold Star Clubmans and Road Racing Trials and Scrambles	2-1462	Rear mudguard stay fixing bolt washer (spring)	4
118	350c.c. 500c.c. Gold Star Clubmans and Road Racing Trials and Scrambles	24-8784	Rear mudguard bracket bottom fixing bolt washer (spring)	2
119	350c.c. 500c.c. Gold Star Clubmans and Road Racing Trials and Scrambles	42-6752	Rear mudguard stay complete (offside)	1
—	350c.c. 500c.c. Gold Star Clubmans and Road Racing Trials and Scrambles	42-6753	Rear mudguard stay complete (nearside)	1
—	350c.c. 500c.c. Gold Star Clubmans and Road Racing Trials and Scrambles	42-6767	Rear mudguard stay complete (offside)	1
—	350c.c. 500c.c. Gold Star Clubmans and Road Racing Trials and Scrambles	42-6769	Rear mudguard stay complete (nearside)	1
120	350c.c. 500c.c. Gold Star Clubmans and Road Racing Trials and Scrambles	2-923	Rear mudguard stay rear fixing bolt washer (plain)	2
121	350c.c. 500c.c. Gold Star Clubmans and Road Racing Trials and Scrambles	24-6770	Rear mudguard stay rear fixing bolt	2
122	350c.c. 500c.c. Gold Star Clubmans and Road Racing Trials and Scrambles	2-2395	Rear mudguard fixing clip bolt nut	2
123	350c.c. 500c.c. Gold Star Clubmans and Road Racing Trials and Scrambles	2-1462	Rear mudguard fixing clip bolt washer (spring)	2
124	350c.c. 500c.c. Gold Star Clubmans and Road Racing Trials and Scrambles	42-6782	Rear mudguard stiffening plate ((large)	1
125	350c.c. 500c.c. Gold Star Clubmans and Road Racing Trials and Scrambles	27-8560	Rear mudguard stay fixing bolt washer (plain)	4
126	350c.c. 500c.c. Gold Star Clubmans and Road Racing Trials and Scrambles	2-1354	Rear mudguard stay fixing bolt	4
127	350c.c. 500c.c. Gold Star Clubmans and Road Racing Trials and Scrambles	42-6761	Rear mudguard stay bracket (offside)	1
—	350c.c. 500c.c. Gold Star Clubmans and Road Racing Trials and Scrambles	42-6762	Rear mudguard stay bracket (nearside)	1

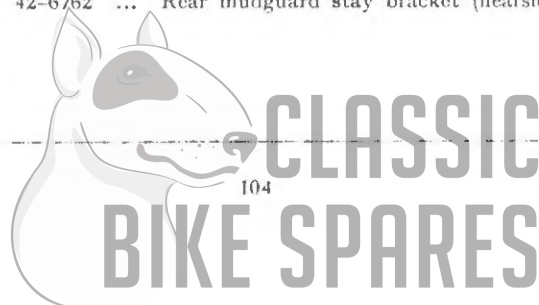

Plate 29—continued.

ACCESSORIES—continued.
350c.c. and 500c.c. Gold Star (Swinging Arm)

Plate Ref. Number.	Models.	Part No.	Description.	Number per set.
128	350c.c. 500c.c. ... Gold Star Clubmans and Road Racing	42-6783	Rear mudguard stiffening plate (small)	1
129	350c.c. 500c.c. ... Gold Star Clubmans and Road Racing	24-8784	Rear mudguard bottom bracket fixing bolt washer (spring)	2
130	350c.c. 500c.c. ... Gold Star Clubmans and Road Racing	2-49	Rear mudguard bottom bracket fixing bolt nut	2
131	350c.c. 500c.c. ... Gold Star Clubmans & Scrambles	2-449	Extension exhaust pipe bracket bolt nut	1
132	350c.c. 500c.c. ... Gold Star Clubmans & Scrambles	2-522	Extension exhaust pipe bracket bolt washer (spring)	1
133	350c.c. 500c.c. ... Gold Star Clubmans & Scrambles	2-803	Extension exhaust pipe bracket bolt	1
134	350c.c. Gold Star ... Clubmans	42-2713	Extension exhaust pipe complete	1
—	500c.c. Gold Star ... Clubmans	42-2720	Extension exhaust pipe complete	1
135	350c.c. 500c.c. ... Gold Star Clubmans & Scrambles	24-7343	Extension exhaust pipe lug bolt	1
136	350c.c. 500c.c. ... Gold Star Clubmans & Scrambles	29-541	Extension exhaust pipe lug bolt washer (shakeproof)	1
137	350c.c. 500c.c. ... Gold Star Clubmans & Scrambles	2-2395	Extension exhaust pipe lug bolt nut	1
138	350c.c. 500c.c. ... Gold Star Clubmans & Road Trim	24-7343	Silencer inlet pipe lug bolt	1
139	350c.c. 500c.c. ... Gold Star Clubmans & Road Trim	29-541	Silencer inlet pipe lug bolt washer (shakeproof)	1
140	350c.c. 500c.c. ... Gold Star Clubmans & Road Trim	2-2395	Silencer inlet pipe lug bolt nut	1
141	350c.c. Gold Star ... Clubmans & Road Trim	42-2725	Silencer complete	1
—	500c.c. Gold Star ... Clubmans & Road Trim	42-2730	Silencer complete	1
142	350c.c. 500c.c. ... Gold Star Road Racing	2-449	Megaphone bracket fixing bolt nut	1
143	350c.c. 500c.c. ... Gold Star Road Racing	2-522	Megaphone bracket fixing bolt washer (spring)	1
144	350c.c. 500c.c. ... Gold Star Road Racing	2-803	Megaphone bracket fixing bolt	1
145	350c.c. 500c.c. ... Gold Star Clubmans and Road Racing Trials and Scrambles	29-7368	Rear brake adjuster nut	1
146	350c.c. 500c.c. ... Gold Star Clubmans and Road Racing Trials and Scrambles	65-6274	Rear brake lever swivel pin	1
147	350c.c. 500c.c. ... Gold Star Clubmans and Road Racing Trials and Scrambles	15-1312	Rear brake rod spring	1
148	350c.c. 500c.c. ... Gold Star Clubmans and Road Racing Trials and Scrambles	2-2395	Rear brake rod spring nut	1



Plate Ref. Number.	Models.	Part No.	Description.	Number per set.
149	350c.c. 500c.c. Gold Star Clubmans and Road Racing Trials and Scrambles	42-7703	Rear chainguard fixing bolt distance tube (short)	1
150	350c.c. 500c.c. Gold Star Clubmans and Road Racing Trials and Scrambles	2-923	Rear chainguard fixing bolt washer	1
151	350c.c. 500c.c. Gold Star Clubmans and Road Racing Trials and Scrambles	33-4089	Rear chainguard fixing bolt (long)	1
152	350c.c. 500c.c. Gold Star Scrambles	42-2710	Extension exhaust pipe complete	1
153	350c.c. 500c.c. Gold Star Road Racing	24-7343	Megaphone inlet pipe lug bolt	1
154	350c.c. 500c.c. Gold Star Road Racing	29-541	Megaphone inlet pipe lug bolt washer (shakeproof)	1
155	350c.c. 500c.c. Gold Star Road Racing	2-2395	Megaphone inlet pipe lug bolt nut	1
156	350c.c. Gold Star Road Racing	42-2734	Megaphone complete	1
—	500c.c. Gold Star Road Racing	42-2740	Megaphone complete	1

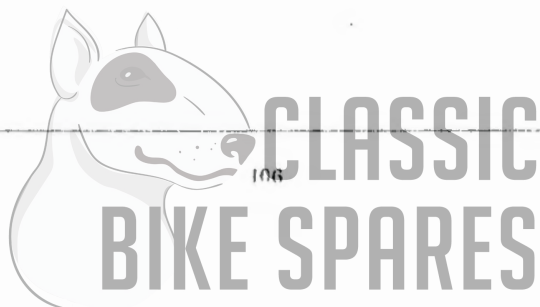

Plate 30

ACCESSORIES

350c.c. and 500c.c. Gold Star (Swinging Arm) Western type Handlebar, Dual Seat Handrail and Mudguard

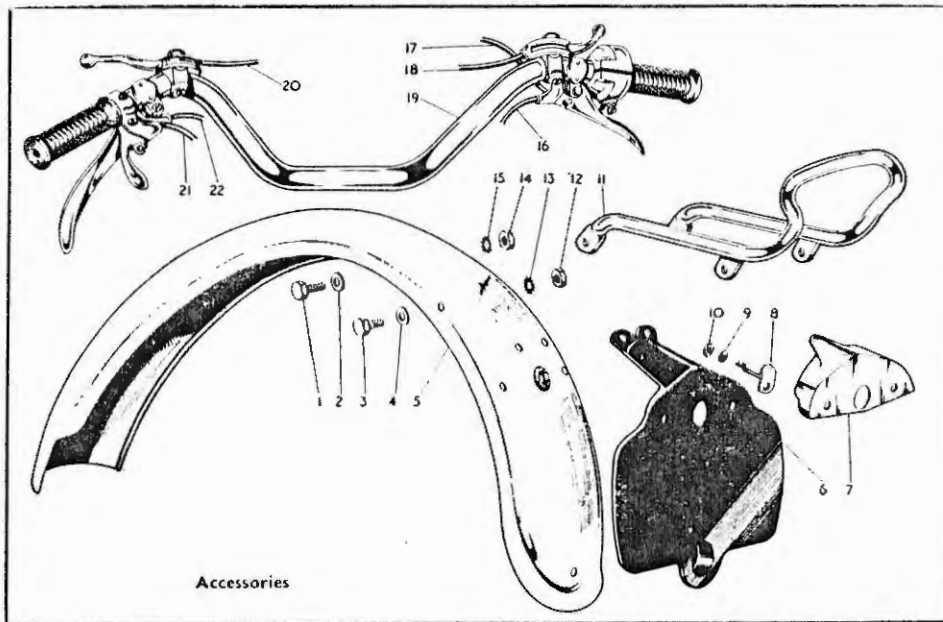

Plate Ref. Number.	Models.	Part No.	Description.	Number per set.
1	350c.c. and 500c.c. Gold Star Clubmans and Road Racing Trials and Scrambles	28-2338	Handrail mudguard stay bolt	2
2	350c.c. and 500c.c. Gold Star Clubmans and Road Racing Trials and Scrambles	2-923	Handrail mudguard stay bolt washer (plain)	2
3	350c.c. and 500c.c. Gold Star Clubmans and Road Racing Trials and Scrambles	24-6770	Handrail mudguard bolt	2
4	350c.c. and 500c.c. Gold Star Clubmans and Road Racing Trials and Scrambles	2-923	Handrail mudguard bolt washer (plain)	2
5	350c.c. and 500c.c. Gold Star Clubmans and Road Racing	42-6750	Rear mudguard with fixed fittings (drilled for twin seat handrail)	1
6	350c.c. and 500c.c. Gold Star Clubmans and Road Racing Trials and Scrambles	90-6797	Rear number plate complete	1
7	350c.c. and 500c.c. Gold Star Clubmans and Road Racing Trials and Scrambles	67-6844	Tail lamp mounting complete (U.S.A. only)	1
8	350c.c. and 500c.c. Gold Star Clubmans and Road Racing Trials and Scrambles	67-6848	Tail lamp mounting stud complete	2

Plate 30—*continued.*

ACCESSORIES—*continued.*

350c.c. and 500c.c. Gold Star (Swinging Arm) Western type Handlebar, Dual Seat Handrail and Mudguard

Plate Ref. Number.	Model	Part No.	Description.	Number per set.
9	350c.c. and 500c.c. Gold Star Clubmans and Road Racing Trials and Scrambles	26-9461	Tail lamp mounting stud washer	4
10	350c.c. and 500c.c. Gold Star Clubmans and Road Racing Trials and Scrambles	21-5161	Tail lamp mounting stud nut	2
11	350c.c. and 500c.c. Gold Star Clubmans and Road Racing Trials and Scrambles	42-9065	Twin seat handrail complete	1
12	350c.c. and 500c.c. Gold Star Clubmans and Road Racing Trials and Scrambles	2-49	Handrail mudguard bolt nut	2
13	350c.c. and 500c.c. Gold Star Clubmans and Road Racing Trials and Scrambles	36-382	Handrail mudguard bolt washer (shakeproof)	2
14	350c.c. and 500c.c. Gold Star Clubmans and Road Racing Trials and Scrambles	2-49	Handrail mudguard stay bolt nut	2
15	350c.c. and 500c.c. Gold Star Clubmans and Road Racing Trials and Scrambles	36-382	Handrail mudguard stay bolt washer (shakeproof)	2
16	350c.c. and 500c.c. Gold Star Clubmans and Road Racing Trials and Scrambles	65-8693	Front brake cable and cover complete (7" brake) (for Western type handlebars).	1
	350c.c. and 500c.c. Gold Star Clubmans and Road Racing Trials and Scrambles	67-8607	Front brake cable and cover complete (8" brake) (for Western type handlebars).	1
17	350c.c. and 500c.c. Gold Star Clubmans and Road Racing Trials and Scrambles	65-8832	Throttle twist grip cable and cover complete	1
18	350c.c. and 500c.c. Gold Star Clubmans and Road Racing Trials and Scrambles	65-8836	Air control cable and cover complete	1
19	—	65-4963	Handlebar (less controls) (Western type)	1
20	350c.c. and 500c.c. Gold Star Clubmans and Road Racing Trials and Scrambles	65-8717	Ignition cable and cover complete	1
21	350c.c. and 500c.c. Gold Star Clubmans and Road Racing Trials and Scrambles	42-8607	Exhaust lifter cable and cover complete	1
22	350c.c. and 500c.c. Gold Star Clubmans and Road Racing Trials and Scrambles	65-8683	Clutch cable and cover complete	1



ENGINE AND FRAME MARKINGS (continued).

Model.	Type.	Engine.	Rigid Frames.	Spring Frame.	Year.	
B31	350c.c. O.H.V.	Z1331-21001 upwards	Z1331 19001	Z1331S-17001	1952	
B32	350c.c. O.H.V. Compet'n	Z1332-5001 upwards			1952	
B32 alloy head & barrel	350c.c. O.H.V. Compet'n	Z1332A-5001 upwards			1952	
B33	500c.c. O.H.V.	Z1333-11001 upwards			1952	
B34	500c.c. O.H.V. Compet'n	Z1334-4001 upwards			1952	
B34 sand cast	500c.c. O.H.V.	Z1334A-4001 upwards			1952	
B34 alloy head and barrel	500c.c. O.H.V.	Z1334A-5001 upwards			1952	
B34 die cast	500c.c. O.H.V.	Z1334A-5001 upwards			1952	
B32 alloy head and barrel	350c.c. Gold Star	ZB32GS-4001 upwards			ZB32S-4001	1952
B32	350c.c. Gold Star Clubmans	ZB32GS-6001 upwards				1952
B34 sand cast	500c.c. O.H.V.	ZB34GS-4001 upwards	1952			
B34 die cast	500c.c. O.H.V.	ZB34GS-5001 upwards	1952			

ENGINE AND FRAME MARKINGS (continued).

Model.	Type.	Engine.	Rigid Frames.	Spring Frames.	Year.
B31	350c.c. O.H.V.	B1331-101 upwards	B1331-101 upwards	B1331S-101 upwards	1953
B32 alloy head & barrel	350c.c. O.H.V. Compet'n	B1332A-101 upwards			1953
B33	500c.c. O.H.V.	B1333-101 upwards			1953
B34 alloy head & barrel	500c.c. O.H.V. Compet'n	B1334A-101 upwards			1953
B32	350c.c. O.H.V. Gold Star	B1332GS-101 upwards			1953
B34	500c.c. O.H.V. Gold Star	B1334GS-101 upwards			1953

SWINGING ARM MODELS.

Model.	Type.	Engine	Frame	Year.
B32	350c.c. O.H.V.	B1332GS-101 upwards	B1332A-101 upwards	1953
B34	500c.c. O.H.V.	B1334GS-101 upwards		1953

STANDARD "B" GROUP GEAR RATIOS (1953).

Standard "B" Group Gearbox (marked STD).

MAINSHAFT.	Part No.	No. of Teeth.	LAYSHAFT.	Part No.	No. of Teeth.
Mainshaft ...	15-4260	—	Layshaft (B31-B33) ...	66-3132	—
Mainshaft Gear ...	66-3212	25	Layshaft (B32-B34) ...	65-3498	—
Mainshaft Gear ...	24-4231	20-16	Layshaft Gear ...	66-3215	25
Dog Clutches ...	24-4393	—	Layshaft Gear ...	66-3209	29
Pinion Sleeve ...	15-4165	—	Layshaft Gear ...	24-4221	20-17

Gearbox Sprocket Size.	Standard Gear Ratios.	B31.	B33.	B32.	B34.
19T x 1/4" (B31) ...	Top	5.6	5.0	7.06	5.64
19T x 1/4" (B33) ...	Third	7.38	6.59	9.30	7.44
16T x 1/4" (B32) ...	Second	11.5	10.3	14.5	11.59
16T x 1/4" (B34) ...	Bottom	16.7	14.9	21.1	16.81

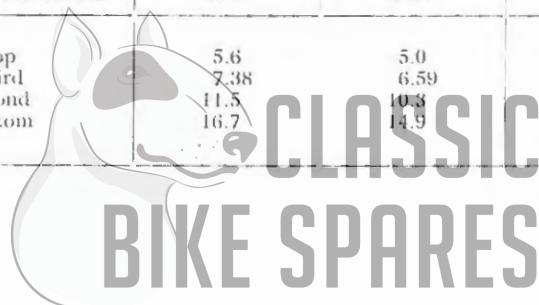

GEAR RATIOS FOR SWINGING ARM MODELS (1953).

MAINSHAFT.	Part No.	No. of Teeth.	LAYSHAFT.	Part No.	No. of Teeth.
Mainshaft	67-3330	—	Layshaft	42-3019	—
Mainshaft Gear ...	67-3191	16	Layshaft Gear ...	42-3020	17
Sliding Gear	67-3202	24	Layshaft Gear ...	67-3199	27
Sliding Gear	67-3201	20	Sliding Gear	67-3198	19
Constant Mesh Gear	67-3192	26	Sliding Gear	42-3023	23

Gearbox Sprocket Size.	Standard Ratios.	B32.	B34.
19T x 1/4"	Top	5.59	5.0
	Third	6.77	6.05
	Second	9.86	8.790
	Bottom	14.40	12.90

**EXTRA CLOSE GEARBOX.
Clubmans and Road Racing (marked RR).**

MAINSHAFT.	Part No.	No. of Teeth.	LAYSHAFT.	Part No.	No. of Teeth.
Mainshaft	67-3330	—	Layshaft	42-3019	—
Mainshaft Gear ...	67-3221	18	Layshaft Gear ...	42-3022	18
Sliding Gear	67-3187	24	Layshaft Gear ...	67-3216	25
Sliding Gear	67-3361	22	Sliding Gear	67-3198	19
Constant Mesh Gear	67-3184	25	Sliding Gear	42-3026	21

Gearbox Sprocket Size.	Standard Ratios.	B32.	B34.
19T x 1/4"	Top	5.28	4.75
	Third	5.80	5.21
	Second	7.00	6.31
	Bottom	10.15	9.15

SCRAMBLES GEARBOX (marked SC).

MAINSHAFT.	Part No.	No. of Teeth.	LAYSHAFT.	Part No.	No. of Teeth.
Mainshaft	67-3315	—	Layshaft	42-3019	—
Mainshaft Gear ...	67-3191	16	Layshaft Gear ...	42-3022	18
Sliding Gear	67-3305	22	Layshaft Gear ...	67-3199	27
Sliding Gear	67-3302	19	Sliding Gear	67-3212	21
Constant Mesh Gear	67-3311	25	Sliding Gear	42-3024	24

Gearbox Sprocket Size.	Standard Ratios.	B32.	B34.
16T x 1/4"	Top	7.75	7.26
	Third	10.25	9.62
	Second	13.65	12.73
	Bottom	18.15	17.00

TRIALS GEARBOX (Wide Ratio).

MAINSHAFT.	Part No.	No. of Teeth.	LAYSHAFT.	Part No.	No. of Teeth.
Mainshaft with Gear	67-3313	—	Layshaft	42-3019	—
Sliding Gear	67-3210	22	Layshaft Gear ...	67-3213	29
Sliding Gear	67-3301	17	Layshaft Gear ...	42-3020	17
Constant Mesh Gear	67-3309	26	Sliding Gear	67-3212	21
			Sliding Gear	42-3025	26

Gearbox Sprocket Size.	Standard Ratios.	B32.	B34.
16T x 1/4"	Top	7.05	5.64
	Third	10.25	8.24
	Second	16.45	13.19
	Bottom	22.35	17.82

